



SW-640L-TX-W

4K Presentation Switcher with Matrix Outputs,
USB 3.0, Multiview & Wireless Casting

User Manual

Version: V1.0.0



Important Safety Instructions

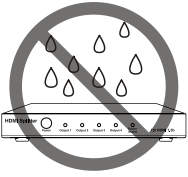

1. Do not expose this apparatus to rain, moisture, dripping or splashing and that no objects filled with liquids, such as vases, shall be placed on the apparatus.

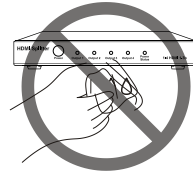

6. Clean this apparatus only with dry cloth.



2. Do not install or place this unit in a bookcase, built-in cabinet or in another confined space. Ensure the unit is well ventilated.

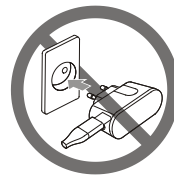

7. Unplug this apparatus during lightning storms or when unused for long periods of time.

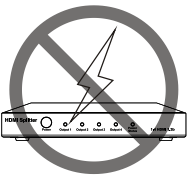

3. To prevent risk of electric shock or fire hazard due to overheating, do not obstruct the unit's ventilation openings with newspapers, tablecloths, curtains, and similar items.

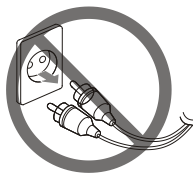

8. Protect the power cord from being walked on or pinched particularly at plugs.



4. Do not install near any heat sources such as radiators, heat registers, stoves, or other apparatus (including amplifiers) that produce heat.



9. Only use attachments / accessories specified by the manufacturer.



5. Do not place sources of naked flames, such as lighted candles, on the unit.

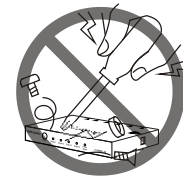

10. Refer all servicing to qualified service personnel.

Table of Contents

Introduction	3
Overview.....	3
Features	3
Package Contents	3
Specifications	4
Panel Description	5
Front Panel	5
Rear Panel.....	6
Installation and Wiring	6
Installation	6
Wiring	7
Application 1: Single HDMI Output	7
Application 2: Dual HDMI Output	7
Key Functions	8
Screen Mirroring	8
(1) Screen Mirroring over Airplay (for Apple Devices).....	8
(2) Screen Mirroring over Miracast (for Android Phones & Windows PCs)	8
(3) Screen Mirroring over Dongle	8
Multiview Display	9
Automatic Signal Switching	9
Display Mechanism of HDMI OUT1 & HDMI OUT2	9
Dual Desktop Mode for HDMI Inputs	9
Guide Screen	10
OSD	10
Network Mode Configuration	11
Using SELECT Button to Perform EDID Copy.....	11
Web UI	12
General Tab	12
Splash Screen	12
USB Switcher	13
Network Settings	13
Network Security	14
Web Password	15
Firmware	15
Version Information	16
Video Settings Tab	16
Input Switching	16
Output Setting.....	16
EDID Settings	17
Auto Switching.....	18
Wireless.....	18
Device Name	18
Wireless Screen Sharing	18
Access Point.....	19
Display Control	20
CEC.....	20
RS-232	21
Control Strategy.....	22
Power On/Off Device	22
Firmware Upgrade	22

Introduction

Overview

The SW-640L-TX-W switcher is a high-performance BYOD presentation switcher with wireless presentation capability. It equips built-in Wi-Fi module and offers multiple access approaches, including Airplay Mirroring, Miracast, Dongle and physical HDMI and USB-C ports, with which you can project the screen contents of your computers (Mac/Windows) or mobile devices (iPhone/iPad/Android phone) to two displays, or to one single display in Multiview mode.

Multiple features like automatic signal switching, dual desktop mode, CEC, Guide Screen, OSD, and EDID copy are also included. The switcher is a collaboration terminal used for meeting room or workgroup discussion.

Features

- Provides two USB-C and two HDMI inputs, plus two HDMI outputs.
- USB-C Inputs support dual-video input (MST1), charging up to 60W, Ethernet connection, and USB 3.0 transmission.
- Supports two HDMI outputs in single view, or one HDMI output in up to quadruple view.
- Supports input resolutions up to 4K@30Hz 4:4:4.
- Supports output resolutions up to 4K@60Hz 4:4:4 (HDMI OUT 1 only).
- Fast seamless switching for both single and Multiview mode.
- Built-in Wi-Fi modules for wireless connectivity with devices over Airplay Mirroring, Miracast, Dongle and Chromecast2.
- Supports wireless conference (using Dongle for connecting between the host PC and USB peripherals wirelessly).
- Built-in quintuple USB 3.0 switcher allows for USB switching among five USB hosts.
- Three Ethernet ports for networking flexibility and security.
- RS-232, PA sensor and relay output for peripherals.
- Detailed and friendly OSD information.
- Multiple control approaches: front panel buttons, Web UI and Telnet API.

***Note:** MST¹ and Chromecast² feature will be available in further firmware version soon.

Package Contents

- 1x SW-640L-TX-W
- 1x 20V 10A Power Supply (US/UK/EU/AU)
- 4x Plastic Mounting Brackets
- 1x 2-pin Phoenix Connector (for PA Sensor)
- 1x 3-pin Phoenix Connector (for Relay)
- 1x 4-pin Phoenix Connector (for RS-232)
- 1x 5-pin Phoenix Connector (for Audio Out)
- 4x Wi-Fi Antennas
- 1x Quickstart Guide

Specifications

Video	
Input Video Port	2x USB-C, 2 x HDMI 3x LAN, 2 x Wi-Fi
Input Video Signal	HDMI: HDMI 1.4, HDCP 1.4 USB-C: DisplayPort 1.1, HDCP 1.4 LAN/Wi-Fi: H.264
Input Resolutions	<p>USB-C/HDMI: 640x480⁸, 800x600⁸, 1024x768⁸, 1280x768⁸, 1280x800⁸, 1280x1024⁸, 1360x768⁸, 1366x768⁸, 1440x900⁸, 1400x1050⁸, 1600x1200⁸, 1680x1050⁸, 1920x1200⁸, 720x480⁸ (480p), 720x576⁶ (576p), 1280x720⁵ (720p30), 1280x720⁶ (720p50), 1280x720⁸ (720p60), 1920x1080² (1080p24), 1920x1080³ (1080p25), 1920x1080⁵ (1080p30), 1920x1080⁶ (1080p50), 1920x1080⁸ (1080p60), 3840x2160⁵ (2160p30)</p> <p>Miracast (Wi-Fi): 640x480⁸, 720x480⁸ (480p), 720x576⁶ (576p), 1280x720², 1280x720³, 1280x720⁵ (720p30), 1280x720⁶ (720p50), 1280x720⁸ (720p60), 1920x1080² (1080p24), 1920x1080³ (1080p25), 1920x1080⁵ (1080p30), 1920x1080⁶ (1080p50), 1920x1080⁸ (1080p60)</p> <p>Airplay Mirroring (Wi-Fi): Up to 1920x1080⁸ (1080p60)</p> <p>ChromeCast* (LAN/Wi-Fi): Up to 1920x1080⁸ (1080p60)</p> <p>Dongle (LAN/Wi-Fi): 1920x1080⁸ (1080p60), 3840x2160⁵ (2160p30)</p> <p>1 = at 23.98 Hz, 2 = at 24 Hz, 3 = at 25 Hz, 4 = at 29.97 Hz, 5 = at 30 Hz, 6 = at 50 Hz, 7 = at 59.94 Hz, 8 = 60 Hz</p>
Output Video Port	2x HDMI
Output Video Signal	HDMI OUT1: HDMI 2.0, HDCP 2.2 HDMI OUT 2: HDMI 1.4, HDCP 1.4
Output Resolutions	<p>HDMI OUT 1: 720x480⁸ (480p60), 720x576⁶ (576p60), 640x480⁸, 800x600⁸, 1024x768⁸, 1280x1024⁸, 1366x768⁸, 1440x900⁸, 1280x800⁸, 1680x1050⁸, 1920x2160⁵, 1600x1200⁸, 1920x1200⁸, 2560x1440⁵, 2560x1440⁸, 1280x720⁶ (720p50), 1280x720⁸ (720p60), 1920x1080⁶ (1080i50), 1920x1080⁸ (1080i60), 1920x1080² (1080p24), 1920x1080³ (1080p25), 1920x1080⁵ (1080p30), 1920x1080⁶ (1080p50), 1920x1080⁸ (1080p60), 3840x2160³ (2160p25), 3840x2160⁵ (2160p30), 3840x2160⁸ (2160p60)</p> <p>HDMI OUT 2: 720x480⁸ (480p60), 720x576⁶ (576p60), 640x480⁸, 800x600⁸, 1024x768⁸, 1280x1024⁸, 1366x768⁸, 1440x900⁸, 1280x800⁸, 1680x1050⁸, 1920x2160⁵, 1600x1200⁸, 1920x1200⁸, 2560x1440⁵, 2560x1440⁸, 1280x720⁶ (720p50), 1280x720⁸ (720p60), 1920x1080⁶ (1080i50), 1920x1080⁸ (1080i60), 1920x1080² (1080p24), 1920x1080³ (1080p25), 1920x1080⁵ (1080p30), 1920x1080⁶ (1080p50), 1920x1080⁸ (1080p60), 3840x2160³ (2160p25), 3840x2160⁵ (2160p30)</p> <p>1 = at 23.98 Hz, 2 = at 24 Hz, 3 = at 25 Hz, 4 = at 29.97 Hz, 5 = at 30 Hz, 6 = at 50 Hz, 7 = at 59.94 Hz, 8 = 60 Hz</p>

Note: Chromecast* will be available in further firmware version soon.

Audio	
Input Audio Port	2x HDMI, 2x USB-C, 3x LAN, 2x Wi-Fi
Input Audio Signal	RAW PCM 2.0, 16 bit, 32/44.1/48KHz sps
Output Audio Port	2 x HDMI, 1 x Analog Audio Out
Output Audio Signal	HDMI: RAW PCM 2.0, 16 bit, 48KHz sps Analog Audio: Balanced stereo

Wi-Fi	
Standard	IEEE 802.11 a/b/g/n/ac
Frequency	Dual bands, 2.4~2.4835GHz, 5.0~5.8GH
Throughout	2 x Wi-Fi, 2T x 2R, up to 867Mbps
Security	WEP, TKIP, AES, WPA, WPA2

Control	
Control Connector	<ul style="list-style-type: none"> • Front panel buttons • 1x LAN (one of the three LAN ports) • RS-232
Control Method	Front panel buttons, LAN (Web UI & Telnet API), RS-232

General	
Operation Temperature	0 to 45°C (32 to 113°F), 10% to 90%, non-condensing
Storage Temperature	-20 to 70°C (-4 to 158°F), 10% to 90%, non-condensing
ESD Protection	Human-body Model: ±8kV (Air-gap discharge)
Power Supply	20V 10A DC
Power Consumption	160W (Max)
Device Dimensions (WxHxD)	215mm x 42mm x 180.2mm / 8.46" x 1.65" x 7.09" (Antennas not included)
Net Weight	1.18kg/2.60lbs (Antennas not included) / 1.20kg/2.64lbs (Antennas included)

Panel Description

Front Panel

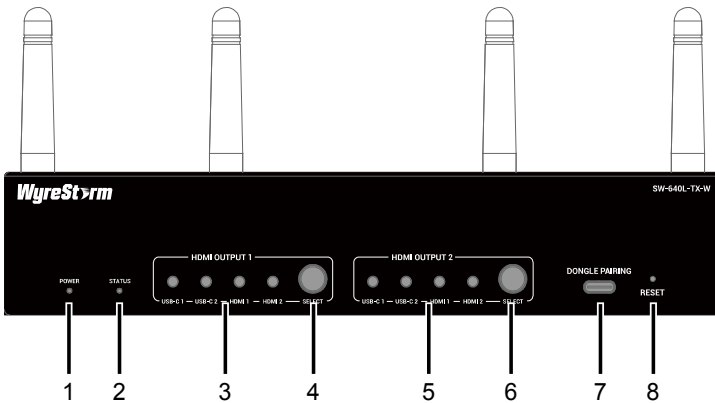

#	Name	Description
1	Power LED	<p>On: The device is powered on.</p> <p>Off: The device is powered off.</p>
2	Status LED	<p>On: The device is working properly.</p> <p>Off: The device is in standby status.</p>
3	HDMI Output 1	<p>USB-C 1 ~ HDMI 2 LEDs, each of which includes three indications:</p> <p>On: The corresponding video source is valid and being output to HDMI OUT 1.</p> <p>Blinking: The corresponding video source is being output to HDMI OUT 1 but not valid.</p> <p>Off: The corresponding video source is not being output to HDMI OUT 1.</p>
4		<p>SELECT Button that provides two operation methods:</p> <ul style="list-style-type: none"> • Short press to cycle through the four input sources USB-C 1, USB-C 2, HDMI 1 and HDMI 2. • Press and hold for at least two seconds to copy EDID of the HDMI display at HDMI OUT 1 to the selected video source. For more information, refer to the Using SELECT Button to Perform EDID Copy section.
5	HDMI Output 2	<p>USB-C 1 ~ HDMI 2 LEDs, each of which includes three indications:</p> <p>On: The corresponding video source is valid and being output to HDMI OUT 2.</p> <p>Blinking: The corresponding video source is being output to HDMI OUT 2 but not valid.</p> <p>Off: The corresponding video source is not being output to</p>
6		<p>SELECT Button, provides two operation methods:</p> <ul style="list-style-type: none"> • Short press to cycle through the four input sources: USB-C 1, USB-C 2, HDMI 1 and HDMI 2. • Press and hold for at least two seconds to copy EDID of the HDMI display at HDMI OUT 1 to the selected video source. For more information, refer to the Using SELECT Button to Perform EDID Copy section.
7	Dongle Pairing	USB-C connector. Connect to a Dongle for pairing or for upgrading the dongle's firmware.
8	Reset	<p>A recessed button that provides two operation methods:</p> <ul style="list-style-type: none"> • Short press the button to show OSD (On-screen Display) on the attached HDMI displays. • Press and hold the button for at least five seconds and then release, the device will automatically reboot and restore to its factory defaults.

Rear Panel

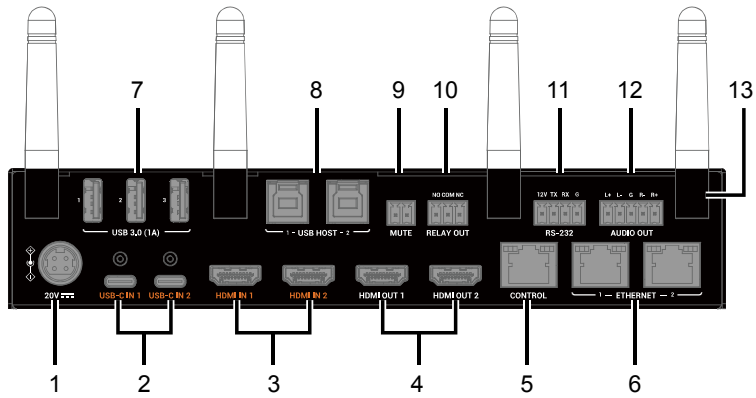

#	Name	Description
1	20V	Connect to the power adapter and the AC power cord provided.
2	USB-C Input 1-2	2 x USB-C ports that provide charging of the USB-C devices, 1000BASE-T Ethernet connection and dual-video input (MST). Connect to USB-C sources.
3	HDMI Input 1-2	Connect to HDMI sources.
4	HDMI Output 1-2	Connect to HDMI displays.
5	Control	Connect to network devices for LAN control, network access and Airplay Mirroring signal input.
6	Ethernet 1-2	For more information about the method of application for the three Ethernet ports, refer to the Network Mode Configuration section.
7	USB 3.0 (1A) 1-3	3 x USB 3.0 type-A ports for the following two functions: 1. Connect to USB peripheral devices (e.g. keyboard, mouse, touch screen, camera, speakerphone, etc.) for USB expansion. Note: Each USB-A port can output DC 5V 1A power to the attached USB peripheral device. 2. Connect to a USB flash drive for firmware upgrade. More information, see Firmware Upgrade section.
8	USB HOST 1-2	2 x USB 3.0 Type-B connectors. Connect to USB host devices.
9	Mute	Connect to the PA sensor for muting/unmuting the audio of HDMI OUT 1-2 and analog AUDIO OUT.
10	Relay Out	Connect to a relay device for relay control.
11	RS-232	Serial port for the following two functions: • Connect to the RS-232 port of an RS-232 device (e.g. a computer) to control this device. • Connect to the RS-232 port of a peripheral (e.g. a projector) to control the peripheral. Pins TX, RX, GND are used to control the attached RS-232 device. Pins 12V, GND are used to output 12V DC power.
12	Audio Out	5-Pin analog audio port, connect to an audio receiver (e.g. an amplifier) for audio de-embedded output.
13	Antenna	Connect to the antenna set for the access to Miracast and soft AP function.

Installation and Wiring

Installation

Note: Before installation, please ensure the device is disconnected from the power source.

Attaching Antennas

1. Attach an antenna provided to the threaded connector, and screw it down clockwise.

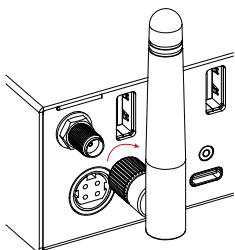

2. Repeat the above step for other antennas.

Attaching Installation Brackets

1. Attach the installation bracket to the enclosure using the screws provided in the package. The bracket is attached to the enclosure as shown.

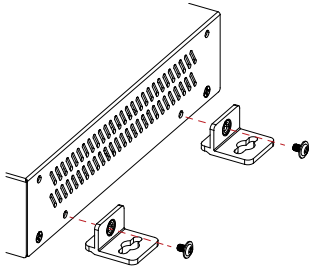

2. Repeat step 1 for the other side of the device.

3. Install the brackets on the position as required using screws (screws are not included in the package).

Wiring

Warning! Before wiring, disconnect the power from all devices. During wiring, connect and disconnect the cables gently.

Application 1: Single HDMI Output

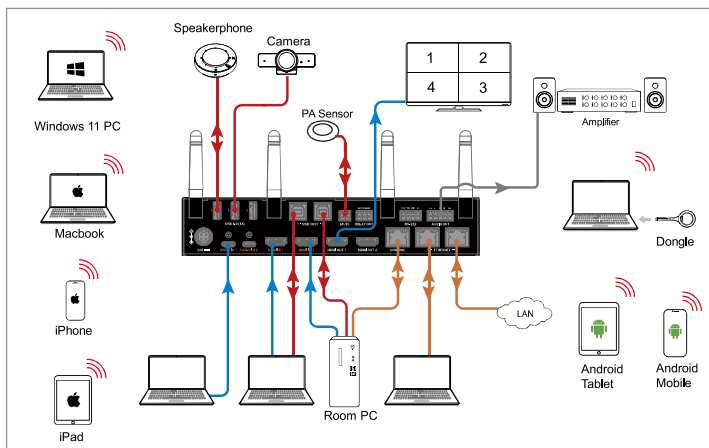

Features

- In this application scenario, only one HDMI display is connected to either HDMI OUT 1 or HDMI OUT 2, and up to four video sources can be displayed on the single screen (quadruple view).
- Your laptop is connected to the device's USB-C IN port, this setup brings you the best experience. An alternative connection is the combination of the USB HOST and HDMI IN port.
- You can use a Dongle to connect your laptop to the device plus the camera and speakerphone wirelessly at the device after the Dongle is paired with the device successfully.
- You can project the screen content of your laptop and mobile devices to the device wirelessly over Airplay Mirroring and Miracast.
- This device is configured in Isolated Network mode: the CONTROL port is assigned specifically to the controller for controlling this device, the ETHERNET 1/2 port can be used for BYOD communication and the attached PC to access network.

Application 2: Dual HDMI Output

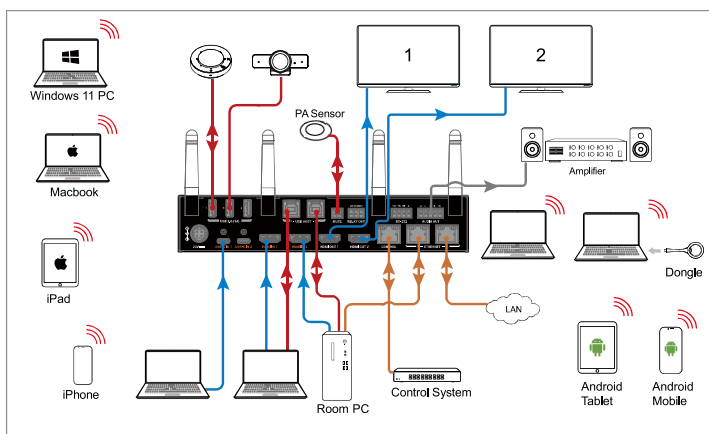

Features

- In this application scenario, two HDMI displays are connected to two HDMI outputs respectively, which can be bound to the laptop attached to USB-C IN 1/2 as two extended desktops.
- You can use a Dongle to connect your laptop to the device plus the camera and speakerphone wirelessly at the device after the Dongle is paired with the device successfully.
- You can project the screen content of your laptop and mobile devices to the device wirelessly over Airplay Mirroring and Miracast.
- This device is configured in Isolated Network mode: the CONTROL port is assigned specifically to the controller for controlling this device, the ETHERNET 1/2 port can be used for BYOD communication and the attached PC to access network.

Key Functions

Screen Mirroring

If you're working on a PC and want its apps and content to be shown on another screen, you'll want to consider mirroring your PC's screen to that screen. With screen mirroring support, the device allows you to share your mobile devices' content wirelessly on any HDMI displays over Airplay Mirroring, Miracast and Dongle.

In this manual, mobile devices available for screen mirroring are referred to as "screen mirroring source", which include Apple devices (iPhone/iPad/Mac), Android phones, Windows PCs and Dongles.

(1) Screen Mirroring over Airplay (for Apple Devices)

1. Connect your iPhone/iPad/Mac to the soft AP of the device.



Soft AP SSID: As same as the switcher's device name and can be obtained from OSD at the upper right of the display screen. By default, it is set as SW-640L-TX-W.

Password: Set through Web UI or Telnet API and can be obtained from OSD at the bottom right of the display screen. By default, it is set as 12345678.

2. Open Control Center on your Apple device, tap  to select appropriate mirroring device (default device name is SW-640L-TX-W) from the pop-up menu.
3. To disconnect Apple device from the switcher: click Stop Mirroring, the display stops displaying your device's screen.

(2) Screen Mirroring over Miracast (for Android Phones & Windows PCs)

For Android mobiles (take Samsung Galaxy series for example):

1. Enable the Wi-Fi or WLAN feature of your mobile device.
2. On your mobile device, swipe down from the top and tap  or  to select appropriate mirroring device from the pop-up CONNECT menu.
3. To disconnect mobile phone from the switcher: click "DISCONNECT" on your mobile phone's screen.

Note:

- The icon, instruction and entrance of the Miracast function may vary on different Android mobiles, please refer to your mobile's manual to get accurate instruction.
- If you fail to use Miracast function, please disable the mobile's Wi-Fi and enable it later, or restart the mobile if necessary.

For Windows PC (Window 10 or higher):

1. Enable the Wi-Fi or WLAN feature of your PC.
2. On your PC, press the combination keys " + K" to select appropriate mirroring device from the pop-up menu.
3. To disconnect PC from the device: click Disconnect, the display stops displaying PC's screen.

Note:

The icon and interface of the Miracast function may vary on different computers. Some Windows 10/11 computers may fail to perform screen mirroring over Miracast due to compatibility issues.

 **Tip:** Both the Airplay mirroring and Miracast support access code. If you see the PIN entry window appears on your devices, input the access code which can be obtained through OSD. (See "OSD" section for more information.)

(3) Screen Mirroring over Dongle

A Dongle (APO DG2) enables users to share laptop's content on a display wirelessly without even installing an application.

To pair a Dongle:

1. **Pair a Dongle with the device.**
Connect a Dongle to the DONGLE PAIRING port of the device for pairing. Once pairing is completed, "Pairing successful" appears on the display screen.
2. **Connect the Dongle to a laptop.**
Connect the Dongle to the laptop, it will start running and connecting to the device's soft AP. Once the Dongle connects to the device successfully, the Dongle LED stops blinking and starts lighting constantly.
3. Now press the Dongle's projecting button, you can share your laptop's screen on the display immediately. Press and hold the button for at least 5 seconds, you will have your laptop's screen displayed in full screen.

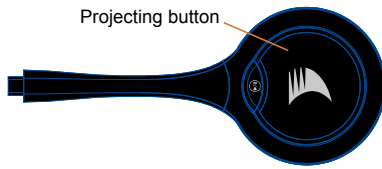

Note: For more information about the Dongle, see its user guide.

Multiview Display

When only one HDMI display is attached to either HDMI OUT1 or HDMI OUT2, the device supports up to four video sources to be played on the display screen as the following:

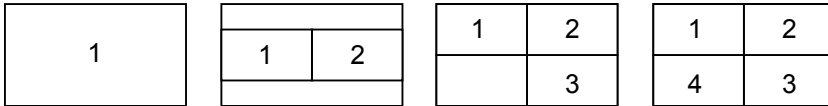

1. As the video sources to be displayed increase or decrease, the device automatically changes to a new screen layout so that all video sources can be displayed appropriately on the entire screen.
2. As the video sources increase till there's no available screen layout to accommodate for all these sources, if a new video source inputs, the source that displays on the screen for the longest will be displaced by the latest input source.

If you use the SELECT button on front panel to select a video source to be played, the device will exit Multiview Display mode and display the source in full screen.

Automatic Signal Switching

The device supports automatic signal switching function, allowing you to easily and quickly output desired sources. It follows Last-In-First-Out rule:

1. When only one video source is connected to the device, HDMI OUT 1 and/or HDMI OUT 2 will automatically output this video source to the display screen(s).
2. When a video source is to be input in the case that four video sources are being played in quadruple view on one display screen, this latest input source will displace the source that is present the longest. More information, see the switching mechanism in [Multiview Display](#) section.
3. When no active video source is connected to the device, the output display shows the Guide Screen image finally.

The device also provides three methods to select specific video source manually:

1. Using the front panel buttons to output corresponding hardware video source.
2. Using web UI.
3. Using API commands. For more information, please see the separate API documentation.

Display Mechanism of HDMI OUT1 & HDMI OUT2

By default, when HDMI OUT1 and HDMI OUT2 are connected to two display screens respectively, the two output ports work as follows:

1. Each of the HDMI outputs displays the video in full screen view.
2. If the device detects no active video source, both HDMI outputs display Guide Screen.
3. If the device detects only one active video source, both HDMI outputs display this video source.
4. If the device detects the quantity of the input video source increases

Dual Desktop Mode for HDMI Inputs

Dual Desktop mode is available and runs as follows:

1. When HDMI IN1 and HDMI IN2 are being output, Dual Desktop mode is activated: the source at HDMI IN1 is delivered to HDMI OUT1, and source at HDMI IN 2 is assigned to HDMI OUT2.
2. If a video source is to be input in the case that Dual Desktop mode is activated, the source that is assigned to HDMI OUT2 will be displaced by the recently input source, and the device will exit Dual Desktop mode.
3. When Dual Desktop mode is activated, if one HDMI source at either HDMI IN1 or HDMI IN2 is removed from the device, the device exits Dual Desktop mode and the two HDMI outputs display another HDMI source.

Guide Screen

The device outputs Guide Screen image when no video source is selected or being output. The Guide Screen can be personalized on the device's Web UI page to convey customized connection instructions.

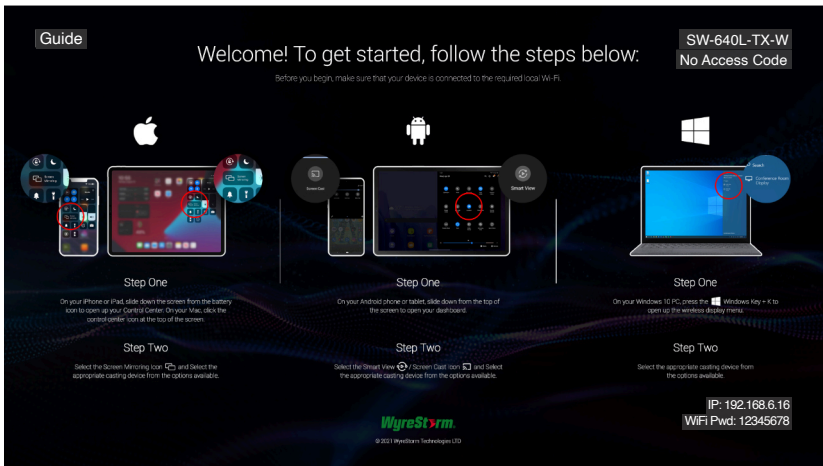

The Guide Screen is accessible in the following cases:

- **Automatic switching:**
Disconnect all video sources from the device, the Guide Screen appears automatically.
- **Manual switching:**
Log on to the web UI page to select Guide Screen for the HDMI outputs. For more information see the [Input Switching](#) section. Send API command through telnet to the device to show the Guide Screen. For more information see the separate API documentation.

Tip: This Guide Screen image can be changed through Web UI, for more information refer to [Splash Screen](#) section. By default, if the device is outputting Guide Screen picture for 60 seconds, a 60-second OSD countdown will appear on the Guide Screen. When the countdown reaches zero, the device will enter standby status.

OSD

The device comes with OSD (On Screen Display) support, enables users to view basic information of the device, including video source channel, access code, device name and IP address, etc. Here are two different OSD examples:

Example 1: Full Screen Mode



Note:

- When the device outputs Guide Screen image, the OSD is shown all the time.
- When the switcher outputs specific video sources, the OSD will display on the display device for 10 seconds and then disappear.
- By default, the access code is set as blank, therefore the OSD doesn't display the access code. If you want to set access code, please see [Access Point](#) section for more information.

Example 2: Multiview Display Mode

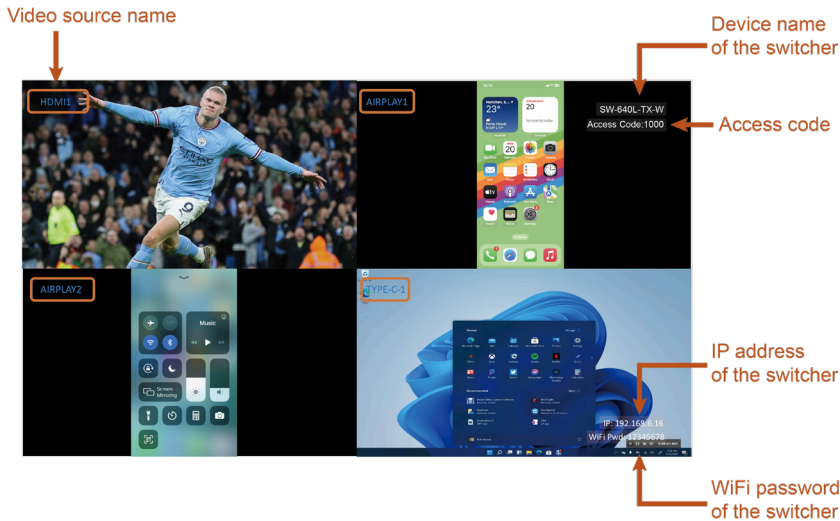

Network Mode Configuration

The device equips three Ethernet ports for networking flexibility and security, which supports the following two network modes:

Transparent Mode (Default Setting)

In this mode, all three Ethernet ports are inter-connective with others, any one of which is able to connect to the LAN where a controller resides for controlling the device, and the rest can be used for BYOD.

Isolated Mode

When the configuration item "Secure Ethernet Mode" on web UI are set to Enable, Isolated mode is activated. For more information about enabling "Secure Ethernet Mode", refer to [Secure Ethernet Mode](#) section. In Isolated mode, the CONTROL port is used for controlling the device; the other two are for BYOD communication and for the attached device to access network.

Using SELECT Button to Perform EDID Copy

The SELECT button can be used to copy EDID of the corresponding HDMI display to the selected input port.

1. Before you perform EDID copy, complete the following:
 - a) Select only one input port for the certain HDMI output at one time, ensure the input port is connected to a valid video source.
 - b) Connect the HDMI output to an HDMI display.
2. Press and hold the SELECT button for at least 2 seconds, if the input port LED blinks 3 times quickly, it indicates that the EDID copy succeeds; if all input port LEDs of the HDMI output blink 2 times quickly, it indicates that EDID copy fails.

Web UI

The Web UI is an intuitive software interface for users to manage and control the device with ease, which be accessed through a web browser, e.g. Chrome, Safari, Firefox, Microsoft Edge, etc.

To access the Web UI:

1. Connect the CONTROL port (or the ETHERNET 1/2 port in Transparent Network mode) of the device to a local area network.
Tip: Ensure there's a DHCP server in the network so that the device can obtain a valid IP address.
2. Connect the PC to the same network as the device.
3. Input the device's IP address in the browser and press Enter, the following window pops up. To quickly view the IP address, see [OSD](#) section.

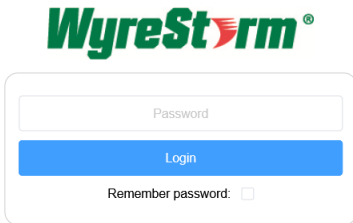

The image shows the login page of the WyreStorm web interface. At the top is the WyreStorm logo. Below it is a text input field labeled "Password". Underneath the field is a blue "Login" button. At the bottom of the form is a "Remember password:" checkbox.

4. Input the password (default password: admin) and click Login.
Set up a new login password in the following dialog box and Save and Continue to enter the main page.
Note: The new password must be alphanumeric only with 4 to 16 characters in length.

Please change your password to continue.

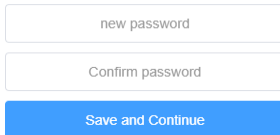

The image shows a form for changing the password. It consists of three elements: a text input field labeled "new password", a second text input field labeled "Confirm password", and a blue "Save and Continue" button at the bottom.

The main page is split into the following tabs: General, Video Settings, Wireless and Display Control.

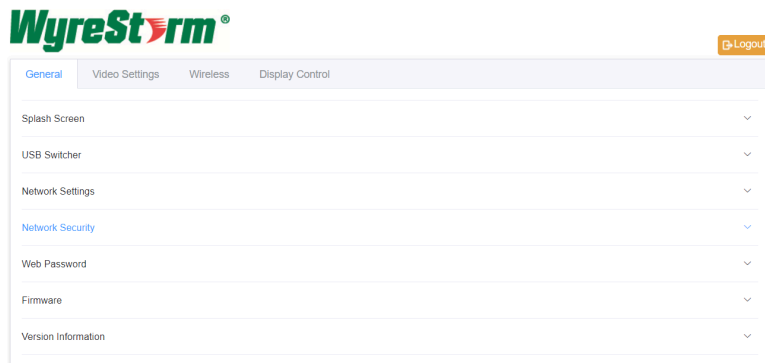

The image shows the main settings page of the WyreStorm web interface. At the top is the WyreStorm logo and a "Logout" button. Below the logo are four tabs: "General", "Video Settings", "Wireless", and "Display Control". The "General" tab is selected. Underneath the tabs is a list of settings categories, each with a dropdown arrow: "Splash Screen", "USB Switcher", "Network Settings", "Network Security", "Web Password", "Firmware", and "Version Information".

General: provides settings of splash screen, USB switcher, network, network security, login password, firmware, system reboot, etc.

- Video Settings: provides settings of input switching, output, EDID and auto switching.
- Wireless: provides settings of device name, wireless screen sharing and access point.
- Display Control: provides settings of CEC, RS-232, control strategy and display on/off.

General Tab

Splash Screen

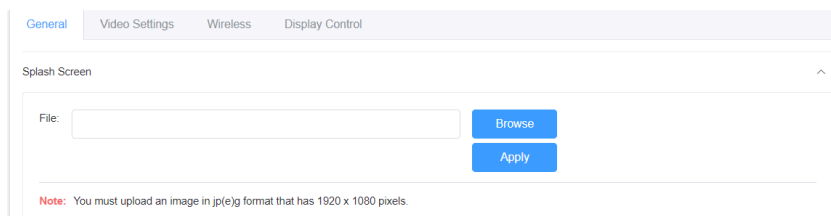

The image shows the "Splash Screen" settings page in the General tab. It features a "File:" label followed by a text input field, a blue "Browse" button, and a blue "Apply" button. Below the input field is a red "Note" that reads: "You must upload an image in jp(e)g format that has 1920 x 1080 pixels."

- Browse: click to select a new picture for the splash screen.
Note: Picture in jp(e)g format with 1920x1080 pixels is recommended.
- Apply: click to upload the selected picture to the device.

USB Switcher

USB Switcher

UI Element	Description
USB Host	<p>Click to select the USB host port of the built-in USB 3.0 switcher:</p> <ul style="list-style-type: none"> • USB-C-1: Select USB-C IN 1 as the USB host. • USB-C-2: Select USB-C IN 2 as the USB host. • HOST 1: Select USB HOST 1 as the USB host. • HOST 2: Select USB HOST 2 as the USB host. • Disconnected: Disconnect the link between the USB host and USB devices. • Auto: Select among the above USB host ports as the USB host automatically. In this mode, the latest connected USB channel (USB-C 1 / USB-C 2 / USB HOST 1 / USB HOST 2 / Dongle) will be selected as the USB host automatically. By default, it is set as Auto.
Apply	Click to perform current settings.

Network Settings

Network Settings

Secondary Ethernet Port

This section is for network settings of the device's Ethernet ports.

For Primary Ethernet port:

UI Element	Description
IP Mode	Select IP addressing mode between DHCP and Static. Default setting: DHCP
IP Address	Set IP address manually for the device when Static mode is selected.
Netmask	Set subnet mask manually for the switcher when Static mode is selected.
Gateway	Set gateway address manually for the device to communicate with another network when Static mode is selected.
DNS Server 1	Set DNS server manually for the device to ensure normal network communication.
DNS Server 2	
Apply	Click to save and perform current settings. Note: After the IP settings are changed, please refresh the Web UI page to log back in.

For Secure Ethernet Mode:

UI Element	Description
Secure Ethernet Mode	<p>To enable or disable the Secure Ethernet Mode.</p> <ul style="list-style-type: none"> • Enable: Select to activate Isolated mode. In Isolated mode, setting of "Secondary Ethernet Port" is available, and "Primary Ethernet Port" is associated with the CONTROL port for controlling this device, "Secondary Ethernet Port" is associated with the network where Ethernet 1/2 is connected for BYOD communication and network access. • Disable: Select to activate Transparent mode. In Transparent mode, setting of "Secondary Ethernet Port" is unavailable, all three Ethernet ports are interconnective with others. <p>Default setting: Disable Note: For more information about the two network modes above, refer to Network Mode Configuration section.</p>

For Secondary Ethernet port:

When "Secure Ethernet Mode" is set to **Enable**, the IP settings are similar with that of the Primary Ethernet Port, but you must ensure that the Primary and Secondary Ethernet ports are set to different network segments.

Network Security

Network Security ^

Telnet over TLS Disable ▾

[Apply](#)

Old Password

New Password

Confirm New Password

Note: Password must be 4 to 16 characters in length, alphanumeric only.

[Apply](#)

HTTPS Enable ▾

[Apply](#)

Show IP address on Guide screen Enable ▾

[Apply](#)

This section is for security settings to limit unauthorized access to the device.

UI Element	Description
Telnet over TLS	To enable/disable TLS authentication for telnet connection. Default setting: Disable
Old Password	Input the old password for the telnet over TLS authentication.
New Password	Configure a new password for the telnet over TLS authentication.
Confirm Password	Confirm the new password again for the telnet over TLS authentication.
HTTPS	Click to enable/disable HTTPS authentication service. Default setting: Enable
Show IP address on Guide Screen	Click to enable/disable IP address display on Guide Screen. Default setting: Enable
Apply	Click to save and perform current settings.

Web Password

Web Password

New Password

Confirm new password

Note: Password must be 4 to 16 characters in length, alphanumeric only.

[Apply](#)

UI Element	Description
New Password	Set a new password to log on to the device's web UI page. Note: The new password must be 4 to 16 characters in length, alphanumeric only.
Apply	Click to perform current settings.

Firmware

Firmware

Upgrade

File: [Browse](#)

[Apply](#)

Note: The legal firmware package is a .zip archive. The system will be rebooted to finish upgrading.

[Reboot](#) [Reset To Factory Default](#) [Export Log](#)

UI Element	Description
Browse	Click to browse for the local upgrade file.
Apply	Click to upload the firmware file to the device and perform firmware upgrade.
Reboot	Click to restart the device.
Reset to Factory Default	Click to restore the device to its factory defaults. You can also perform this task by using the Reset button on front panel.
Expert Log	Click to export system log.

Version Information

Version Information

Version	V1.0.6T2
Build Time	2024.03.13 09:52:32

UI Element	Description
Version	Shows the device's firmware version.
Build Time	Shows the time and date when the device's firmware was built.

Video Settings Tab

Input Switching

Input Switching

HDMI OUT1	HDMI OUT2	Video Source	Timing	Format	Addition
<input type="radio"/>	<input type="radio"/>	TYPE-C-1	NoSignal		
<input type="radio"/>	<input type="radio"/>	TYPE-C-2	NoSignal		
<input type="radio"/>	<input checked="" type="radio"/>	HDMI1	1920x1080P@60	RGB888	
<input type="radio"/>	<input type="radio"/>	HDMI2	NoSignal		
<input type="radio"/>	<input type="radio"/>	AIRPLAY1	3840x2160P@60	H264	

Show Guide Screen

This section is used for switching among multiple input sources for the HDMI OUT 1-2 and displaying the sources' statuses, including video channel names, resolutions and video format.

UI Element	Description
HDMI Out 1	Click the button to select (button turns from white to blue) or deselect (button turns from blue to white) the specified video source for HDMI OUT1.
HDMI Out 2	Click the button to select (button turns from white to blue) or deselect (button turns from blue to white) the specified video source for HDMI OUT2.
Show Guide Screen	Click the button to output the Guide Screen (button turns from white to blue).
Refresh	Click to refresh the current state information.

Output Settings

This section is used for settings of output timing and HDCP, plus Dual Display.

Output Setting

Primary output timing: 3840x2160P@60 Auto

Secondary output timing: 3840x2160P@30 Auto

Output HDCP Support: Enable

Dual Display Settings: Auto

Note: This configuration instructs the device how to show the videos onto the dual displays.
 Fixed: HDMI OUT1 always shows HDMI IN1. HDMI OUT2 always shows HDMI IN2. The wireless cast always shows on HDMI OUT2.
 Auto: The dual displays show video sources according to the built-in (Last in, First Out) policy automatically.

UI Element	Description
Primary Output Timing	Set the output timing for HDMI OUT1. Two operation methods are offered in the following: <ul style="list-style-type: none"> • Auto: select to output the optimal resolution of the attached display based on the display's EDID. E.g. If the recommended resolution for the display is 4K@60Hz, the device will output 4K@60Hz video. • Resolution range list: select a desired output resolution from the dropdown menu to output this fixed resolution. Maximum supported resolution for HDMI OUT1 is 4K@60Hz. Default setting: Auto
Secondary Output Timing	Set the output timing for HDMI OUT2. Two operation methods are offered in the following: <ul style="list-style-type: none"> • Auto: select to output the optimal resolution supported by the attached display based on the display's EDID. • E.g. If the recommended resolution for a display is 4K@30Hz, the device will output 4K@30Hz video • Resolution range list: select a desired output resolution from the dropdown menu to output this fixed resolution. Maximum supported resolution for HDMI OUT2 is 4K@30Hz. Default setting: Auto
Refresh	Click to refresh the latest status of the output timing.
Output HDCP Support	Enable/disable HDCP encryption for HDMI OUT 1-2. Two options are offered in the following: <ul style="list-style-type: none"> Enable: select to enable HDCP encryption for HDMI outputs. Disable: select to disable HDCP encryption for HDMI outputs. Default setting: Enable
Dual Display Settings	This item instructs the device how to assign video sources to HDMI OUT1 and HDMI OUT2. <ul style="list-style-type: none"> • Auto: The two attached HDMI displays select video sources automatically according to the LIFO (Last in, first out) rule. For more information, refer to the Display Mechanism of HDMI OUT 1 & HDMI OUT 2 section. • Fixed: Select to activate Dual Desktop mode. For more information about Dual Desktop mode, refer to the Dual Desktop Mode for HDMI inputs section. Tip: Prior to use Dual Desktop feature, ensure the two HDMI inputs and two output ports are connected to available HDMI devices. Default setting: Auto
Apply	Click to perform current settings.

EDID Settings

EDID Settings

TYPE-C-1	4K@30Hz, Audio 2CH PCM.bin
TYPE-C-2	4K@30Hz, Audio 2CH PCM.bin
HDMI1	4K@30Hz, Audio 2CH PCM.bin
HDMI2	4K@30Hz, Audio 2CH PCM.bin

Note: Restart to take effect.

EDID File:

This section is used for EDID settings of input ports.

UI Element	Description
TYPE-C-1 / TYPE-C-2 / HDMI1 / HDMI2	Set input EDID for TYPE-C-1 / TYPE-C-2 / HDMI1 / HDMI2. Configuration options are offered in the following: <ul style="list-style-type: none"> • 4K@30Hz, Audio 2CH PCM.bin • 1080P@60Hz, Audio 2CH PCM.bin • 1080P@60Hz, No Audio.bin • 720P@60Hz, Audio 2CH PCM.bin Default setting: 4K@30Hz, Audio 2CH PCM.bin Tip: To input a customized EDID file for the input ports, just upload the EDID file as desired in the EDID File field.
Secondary Output Timing	Browse: Click to select the local EDID file. Upload: Click to upload the EDID file to the device's input ports.

Auto Switching

Auto Switching

The screenshot shows a configuration panel for 'Auto Switching'. It features a dropdown menu currently set to 'Enable' and a blue 'Apply' button at the bottom right.

UI Element	Description
Auto Switching	Click to enable/disable the Auto Switching function. Default setting: Enable Note: For more information about Automatic Switching feature, refer to Automatic Signal Switching .
Apply	Click to perform current settings.

Wireless

Device Name

Device Name

The screenshot shows a configuration panel for 'Device Name'. The text input field contains 'SW-640L-TX-W'. Below the input field, there is a red note: 'Note: The device name must be 1~20 characters in length(letters numbers '_' or '-').' and a blue 'Apply' button.

UI Element	Description
Device Name	Define the device name to an easy-to-remember one. This name also acts as the name for soft AP and for the receiver of Airplay and Miracast. Note: The name must be 1~20 characters in length, including letters, numbers, "_" or "-". By default, it's set as SW-640L-TX-W .
Apply	Click to perform current settings.

Wireless Screen Sharing

Wireless Screen Sharing

The screenshot shows a configuration panel for 'Wireless Screen Sharing'. It has two dropdown menus: 'Band' set to '5G' and 'Channel' set to '48'. There is also a checked 'Auto' checkbox next to the channel dropdown and a blue 'Apply' button at the bottom right.

UI Element	Description
Band	5G: Configure the device's frequency band as 5GHz. 2.4G: Configure the device's frequency band as 2.4GHz. By default, the device works at 5GHz. If your wireless devices don't support 5GHz Wi-Fi, configures the frequency band as 2.4G before connecting them to the device via Miracast. Default setting: 5G
Channel	Configure the device's wireless channel. Default setting: Auto Auto means the device selects a wireless channel automatically for itself.
Apply	Click to perform current settings.

Access Point

Access Point

Soft AP Enable Apply

Soft AP Password 12345678 Apply

Note: The soft ap password must be 8-20 characters in length(letters numbers '_' or '.').

Soft AP Router Enable Apply

Note: This feature depends on the soft AP, to use this feature, please make sure the soft AP is enabled.

BYOD Feature Enable Apply

Access Code (0000 - 9999 or blank) Auto Refresh Apply

UI Element	Description
Soft AP	Click to enable/disable the device's soft AP function. Default setting: Enable
Soft AP Password	Configure the soft AP password. Default setting: 12345678
Soft AP Router	<ul style="list-style-type: none"> Enable: Enable the device's soft AP router function so that wireless devices connected to soft AP are able to access the internet (verify the Ethernet port of the device is connected to the internet). Note: When the device's IP mode is set as Static, you must configure the Ethernet port's gateway and DNS correctly so that soft AP router runs properly. Disable: Disable the device's soft AP function to prevent wireless devices connected to soft AP from accessing the internet. <p>Default setting: Enable Note: Before you intend to use this feature, ensure the soft AP function is enabled.</p>
BYOD Feature	Click to enable/disable the device's BYOD feature. Note: This feature is available for Airplay and Miracast, not for Dongle.
Access Code	Enter a four-digit access code to help prevent users from accidentally connecting to an unintended device and protect from an unauthorized access. <ul style="list-style-type: none"> When an access code is set, it will appear on the upper right corner of the attached display. If you don't want to set access code, you can enter nothing here. <p>By default, it's set as blank.</p>
Apply	Click to perform current settings.

Display Control

CEC

CEC

Configure

Wakeup Command	<input type="text" value="40 04"/>	example: 40 04
Standby Command	<input type="text" value="ff 36"/>	

Note: The format of CEC commands support Hex only, the limitation for longest byte is within 15.

Send

UI Element	Description
Wakeup Command	Enter the CEC wakeup command of the controlled display device in hex. For more information about the command, see the user guide of your display device. Default setting: 40 04
Standby Command	Enter the CEC standby command of the controlled display device in hex. For more information about the command, see the user guide of your display device. Default setting: ff 36
Apply	Click to save and perform current settings.
Wakeup	Click to send the Wakeup command.
Standby	Click to send the Standby command.

RS-232

RS232

Configure

RS232 parameter	<input type="text" value="9600-8n1"/>	example: 115200-8n1
Wakeup Command	<input type="text"/>	
Standby Command	<input type="text"/>	
RS232 hex string enable	<input type="text" value="Enable"/>	

Send

UI Element	Description															
RS-232 Parameter	<p>Set the RS-232 parameters for the controlled display. For more information about the parameters, see the user guide of your display device.</p> <table border="1" style="width: 100%; border-collapse: collapse; margin: 10px 0;"> <thead> <tr> <th>Parameter</th> <th>Value</th> <th>Abbreviation</th> </tr> </thead> <tbody> <tr> <td>Baud rate</td> <td>9600bps</td> <td>9600</td> </tr> <tr> <td>Data Bits</td> <td>8bits</td> <td>8</td> </tr> <tr> <td>Parity</td> <td>None</td> <td>n</td> </tr> <tr> <td>Stop Bits</td> <td>1</td> <td>1</td> </tr> </tbody> </table> <p>Default setting: 9600-8n1</p>	Parameter	Value	Abbreviation	Baud rate	9600bps	9600	Data Bits	8bits	8	Parity	None	n	Stop Bits	1	1
Parameter	Value	Abbreviation														
Baud rate	9600bps	9600														
Data Bits	8bits	8														
Parity	None	n														
Stop Bits	1	1														
Wakeup Command	<p>Enter the RS-232 wakeup command of the controlled display device. For more information about the command, see the user guide of your display device. If you want to disable this function, you can enter nothing here. By default, it's set as blank.</p>															
Standby Command	<p>Enter the RS-232 standby command of a controlled display device. For more information about the command, see the user guide of your display device. If you want to disable this function, you can enter nothing here. By default, it's set as blank.</p>															
RS-232 Hex String Enable	<ul style="list-style-type: none"> • Enable: select to use the RS-232 standby and wakeup commands in hex string form to control your display devices. If this item is enabled, make sure standby and wakeup commands are manually converted to their equivalent hex forms first and then input the RS-232 standby command and RS-232 wakeup command. For example, RS-232 wake up command in hex form may be: 50 57 52 20 4F 4E 0D 0A. • Disable: Select to directly send the original standby or wakeup commands to control the attached display device. Default setting: Disable 															
Apply	Click to perform current settings.															
Wakeup	Click to send the Wakeup command defined in Wakeup Command field to the connected display.															
Standby	Click to send the Standby command defined in Standby Command field to the connected display.															

Control Strategy

Control Strategy

Auto Standby Enable

Apply

Auto Standby Time (Second, ranges from 0 to 3600) 1

Sink Power Mode Both

Apply

UI Element	Description
Auto Standby	<ul style="list-style-type: none"> Enable: To enable auto standby function for the device. If enabled, when there's no valid signal output to the device during a specified period of time, the device will enter standby status automatically. Disable: To disable auto standby function for the device. Default setting: Enable
Auto Standby Time (Second, ranges from 0 to 3600)	Set the standby timeout for the device to enter standby status. <ul style="list-style-type: none"> If the standby timeout doesn't exceed 60 seconds, the 60-second OSD standby countdown of the device will appear on the display screen immediately once it outputs Guide Screen. If the standby timeout is larger than 60 seconds, the 60-second OSD standby countdown of the device will appear on the display screen when the standby timeout has only 60 seconds left. If Auto Standby Time is set to 0, it means the device will enter standby mode immediately once it outputs Guide Screen. For example, an 80-second auto standby time means when the device starts to output Guide Screen, 20 seconds later, a 60-second OSD countdown for the device to enter standby status begins; when the countdown reaches zero, the display enters standby mode. Default setting: 120 seconds
Sink Power Mode	Both: Enable both CEC and RS-232 mode to manage the sink power. CEC: Enable CEC to manage the sink power. RS-232: Enable RS-232 to manage the sink power. Default setting: both
Apply	Click to save and perform current settings.

Power On/Off Device

Power On/Off Device

Power On Power Off

UI Element	Description
Power On	Click to power on the connected displays.
Power Off	Click to power off the connected displays.

Firmware Upgrade

The device supports firmware upgrade through Web UI and USB-A ports on rear panel.

To upgrade firmware through Web UI, see [Firmware](#) section.

To upgrade firmware through USB-A port on rear panel, perform the following:

1. Name the upgrade file package "MS340-update.zip".
2. Create a new folder named "upgrade" under the root directory of a FAT32 or NTFS USB flash drive. Place the upgrade file in this folder.
3. Connect the USB flash drive to either of the switcher's USB-A ports. It will take about 1 minute for the switcher to read the USB flash drive. If the device detects the upgrade file is a newer version, it will start to upgrade. When the upgrade process is completed, the device will reboot automatically.

Note: Before connect a USB flash drive to the device, we recommend that you remove peripheral devices from this device's USB-C IN and USB-B HOST ports. Do not cut off the power source of the device during the upgrade process. If the device detects the upgrade file is not a newer version, it will not start the upgrade.

