

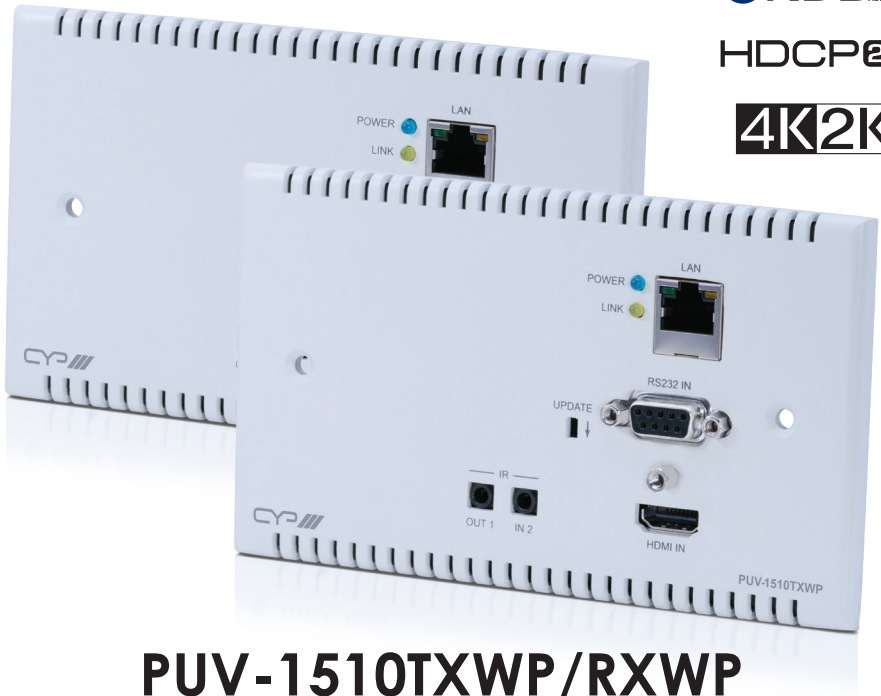

HDBT[®]
AS2

HDCP22

4K2K



PUV-1510TXWP/RXWP

HDMI over CAT5e/6/7 Wallplate Transmitter with 48V PoH

OPERATION MANUAL

DISCLAIMERS

The information in this manual has been carefully checked and is believed to be accurate. CYP (UK) Ltd assumes no responsibility for any infringements of patents or other rights of third parties which may result from its use.

CYP (UK) Ltd assumes no responsibility for any inaccuracies that may be contained in this document. CYP (UK) Ltd also makes no commitment to update or to keep current the information contained in this document.

CYP (UK) Ltd reserves the right to make improvements to this document and/or product at any time and without notice.

COPYRIGHT NOTICE

No part of this document may be reproduced, transmitted, transcribed, stored in a retrieval system, or any of its part translated into any language or computer file, in any form or by any means—electronic, mechanical, magnetic, optical, chemical, manual, or otherwise—without express written permission and consent from CYP (UK) Ltd.

© Copyright 2011 by CYP (UK) Ltd.

All Rights Reserved.

Version 1.1 August 2011

TRADEMARK ACKNOWLEDGMENTS

All products or service names mentioned in this document may be trademarks of the companies with which they are associated.

SAFETY PRECAUTIONS

Please read all instructions before attempting to unpack, install or operate this equipment and before connecting the power supply.

Please keep the following in mind as you unpack and install this equipment:

- Always follow basic safety precautions to reduce the risk of fire, electrical shock and injury to persons.
- To prevent fire or shock hazard, do not expose the unit to rain, moisture or install this product near water.
- Never spill liquid of any kind on or into this product.
- Never push an object of any kind into this product through any openings or empty slots in the unit, as you may damage parts inside the unit.
- Do not attach the power supply cabling to building surfaces.
- Use only the supplied power supply unit (PSU). Do not use the PSU if it is damaged.
- Do not allow anything to rest on the power cabling or allow any weight to be placed upon it or any person walk on it.
- To protect the unit from overheating, do not block any vents or openings in the unit housing that provide ventilation and allow for sufficient space for air to circulate around the unit.

REVISION HISTORY

VERSION NO.	DATE	SUMMARY OF CHANGE
v1.00	22/06/2018	First release

CONTENTS

1. Introduction	6
2. Applications	6
3. Package Contents	6
4. System Requirements	6
5. Features	7
6. Operation Controls and Functions	8
6.1 Transmitter Front Panel	8
6.2 Transmitter Rear Panel	9
6.3 Receiver Front Panel	10
6.4 Receiver Rear Panel	11
6.5 IR Cable Pin Assignments	12
6.6 D-Sub 9-Pin Assignment	12
7. Connection Diagram	13
8. Specifications	14
8.1 Technical Specification	14
8.1 CAT5e/6/7 Cable Specification	16
8.2 Timing Support Chart	16
9. Acronyms	17

1. INTRODUCTION

This HDMI over single Cat5e/6/7 Transmitter and Receiver set can send uncompressed, high resolution, video/audio over a single cable up to a distance of 100 metres. In addition to the audio and video capabilities, it can also bi-directionally transmit RS-232 and IR control signals as well as extending your local LAN to the display device UK 2 gang design allowing install on AC outlet. The Receiver (PD) is powered by the 48V PoE (Power over Ethernet) function of the Transmitter (PSE), allowing for greater flexibility in installations.

2. APPLICATIONS

- /// Household entertainment sharing and control
- /// Lecture room display and control
- /// Showroom display and control
- /// Meeting room presentation and control
- /// Classroom display and control

3. PACKAGE CONTENTS

- /// 1 x HDMI over CAT5e/6/7 Wall-plate Transmitter
- /// 1 x HDMI over CAT5e/6/7 Wall-plate Receiver
- /// 1 x IR Blaster
- /// 1 x IR Extender
- /// 1 x 48V / 0.83A DC power adaptor
- /// 1 x Power cable
- /// 1 x Operation Manual

4. SYSTEM REQUIREMENTS

- /// HDMI input source equipment such as Blu-ray player, game console or set-top box
- /// HDMI output equipment such as an HDTV, projector or AV receiver.
- /// Industry standard Cat6 or Cat6a cables are recommended

5. FEATURES

- /// HDMI with 3D & 4K support. DVI signal compliant
- /// Supports CEC bypass
- /// Simultaneous transmission of uncompressed video, audio and data over a single 100m/328ft Cat5e/6/7 cable
- /// 5Play™ convergence: HDMI, LAN, PoE & Control (IR & RS-232)
- /// Supports resolutions up to 4K@50/60Hz (YUV 4:2:0) and 21:9 aspect ratio
- /// Supports standard 48V PoE from Transmitter (PSE) to Receiver (PD)
- /// Supports HDMI I/O cable distance up to 5m at 4K@50/60Hz (YUV 4:2:0)
- /// Installation friendly wall/table mount case design

Note: 1. *The standard 48V PoE function is designed for powering compatible Receiver units only, non-PoE Receivers will need their own power supply. Receivers of another brand may not be compatible.*

2. *Displaying HDMI 3D and 4K2K contents, equivalent source signal and HDMI cable are required in order to secure the quality.*

6. OPERATION CONTROLS AND FUNCTIONS

6.1 Transmitter Front Panel

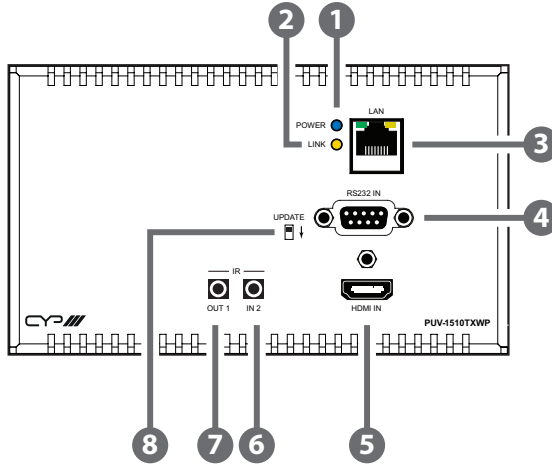

- 1 **POWER:** This LED will illuminate when the device is connected to a power supply.
- 2 **LINK:** This LED will illuminate solid when both Transmitter and Receiver are connected and communicating with each other properly.
- 3 **LAN:** Connect to an Ethernet device or to your local network as appropriate an internet or network system.
- 4 **RS232 IN:** Connect to a PC or laptop with D-Sub 9-pin male cable for the transmission of RS-232 command.
- 5 **HDMI IN:** Connect to the HDMI source equipment such as a game console or Blu-ray player.
- 6 **IR IN 2:** Connect to the supplied IR Extender cables for IR signal reception. Ensure that remote being used is within the direct line-of-sight of the IR Extender.
- 7 **IR OUT 1:** Connect to the supplied IR Blaster cable for IR signal transmission. Place the IR Blaster in direct line-of-sight of the equipment to be controlled.
- 8 **UPDATE:** This switch is reserved for factory use only.

6.2 Transmitter Rear Panel

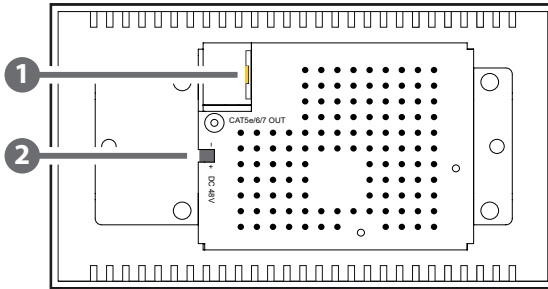

- 1 CAT5e/6/7 OUT:** Connects to the Receiver unit with a single CAT5e/6/7 cable for transmission of all data signals includes power.
- 2 DC 48V:** Plug the 5V DC power supply into the unit and connect the adaptor to an AC outlet.

6.3 Receiver Front Panel

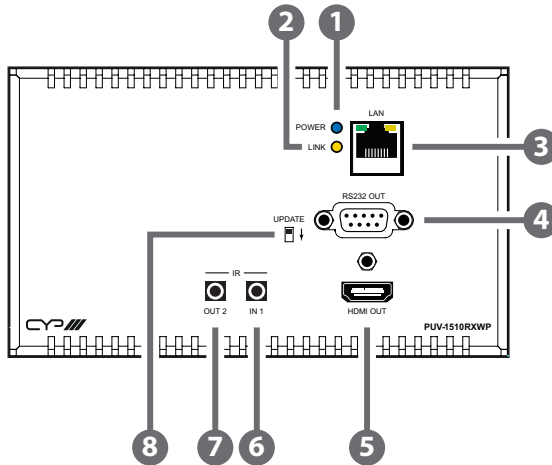

- 1 POWER:** This LED will illuminate when the device is receiving power via PoE (Power over Ethernet).
- 2 LINK:** This LED will illuminate solid when both Transmitter and Receiver are connected and communicating with each other properly.
- 3 LAN:** Connect to an Ethernet device or to your local network as appropriate.
- 4 RS232 OUT:** Connect (via D-Sub 9-pin female cable) to the device that is to be controlled by RS-232 commands.
- 5 HDMI OUT:** Connect to an HDMI equipped display such as an HDTV or projector for display of the HDMI input source signal.
- 6 IR IN 1:** Connect to the supplied IR Extender cable for IR signal reception. Ensure that remote being used is within the direct line-of-sight of the IR Extender.
- 7 IR OUT 2:** Connect to the supplied IR Blaster cable for IR signal transmission. Place the IR Blaster in direct line-of-sight of the equipment to be controlled.
- 8 UPDATE:** This switch is reserved for factory use only.

6.4 Receiver Rear Panel

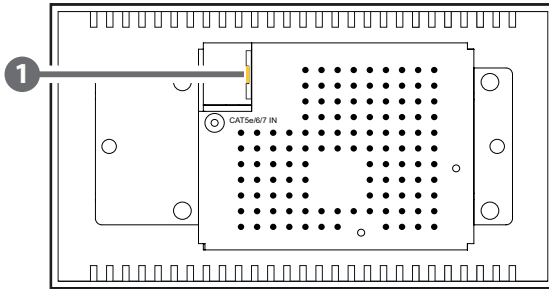

- 1 CAT5e/6/7 IN:** Connect to the transmitter unit with a single CAT5e/6/7 cable for transmission of all data signals and power.

6.5 IR Cable Pin Assignments

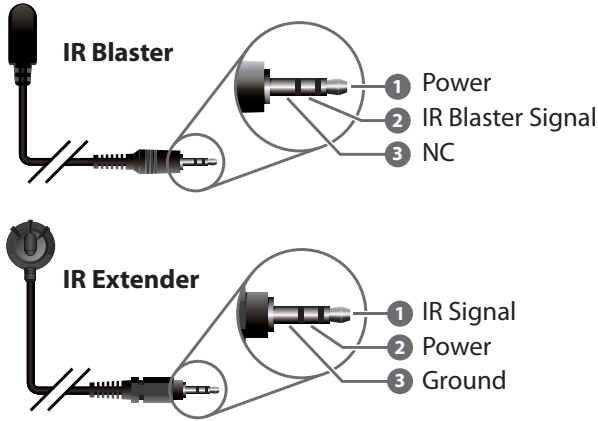

6.6 D-Sub 9-Pin Assignment

Pin	Define TX / RX
1	N/C
2	TxD/RxD
3	RxD/TxD
4	N/C
5	GND
6	N/C
7	N/C
8	N/C
9	N/C
9	NC

7. CONNECTION DIAGRAM

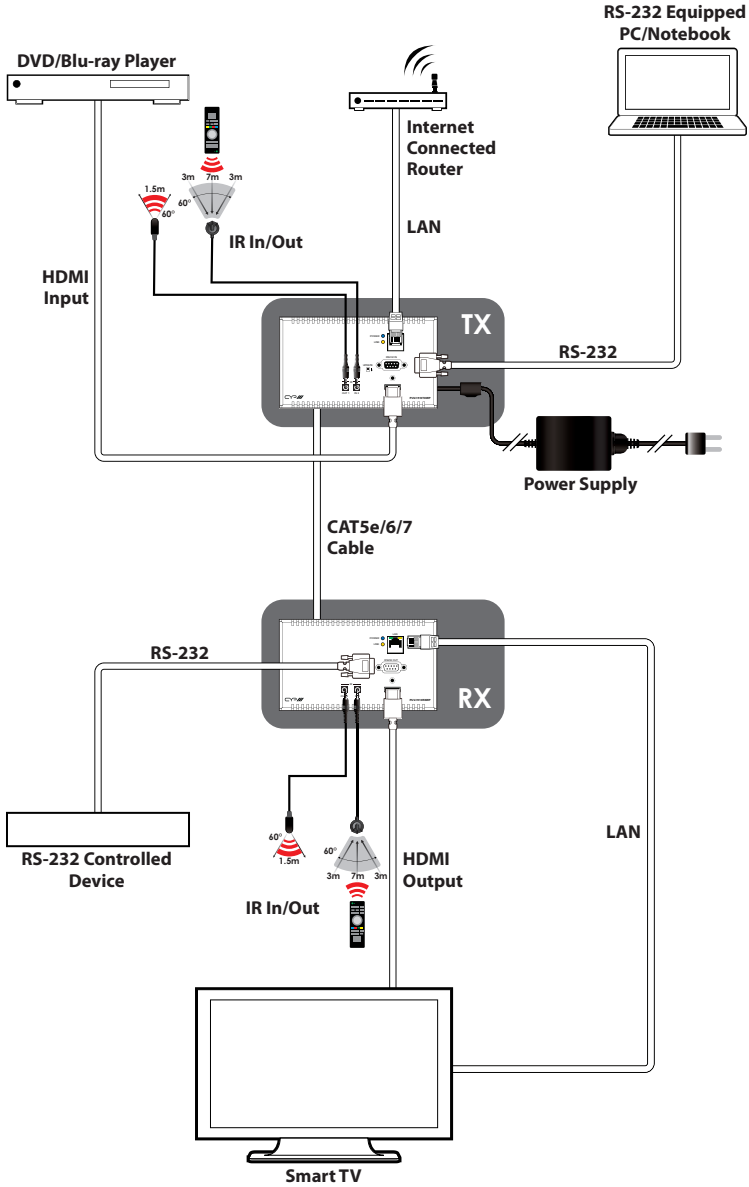

8. SPECIFICATIONS

8.1 Technical Specification

Video Bandwidth	340 MHz/10.2 Gbps
<i>Transmitter</i>	
Input Ports	1 x HDMI 1 x IR In 1 x RS-232 1 x LAN
Output Ports	1 x CAT5e/6/7 1 x IR Out
Other	1 x Update
<i>Receiver</i>	
Input Ports	1 x CAT5e/6/7 1 x IR In
Output Ports	1 x HDMI 1 x RS232 1 x IR Out 1 x LAN
Other	1 x Update
HDMI Resolution	HD: 480i~4K2K@50/60 _ YUV_420 PC: VGA ~ WUXGA (RB)
HDMI Cable Distance	In: 10m/1080p@8-bit or 12-bit and 5m@4K2K Out:10m/1080p@8-bit,5m/1080p@12-bit and 5m@4K2K
CAT5e/6/7 Cable Distance	Up to 100m
IR Frequency	30~50 kHz

ESD Protection	Human Body model: ± 8kV (air-gap discharge) ± 4kV (contact discharge)
Power Supply	48V/0.83 A DC (US/EU standards, CE/FCC/ UL certified)
ESD Protection	Human Body model: ± 12kV (air-gap discharge) ± 8kV (contact discharge)
Dimensions	156mm (L) x 90mm (W) x 38mm (D) Jacks Excluded 156mm (L) x 90mm (W) x 44mm (D) Jacks Included
Weight	312 g/TX, 206g/RX
Chassis Material	Metal
Silkscreen Colour	White
Operating Temperature	0°C~40°C/32°F~104°F
Storage temperature	-20°C~60°C/-4°F~140°F
Relative Humidity	20~90% RH (no condensation)
Power Consumption	12.87 W (Include Receiver)

8.1 CAT5e/6/7 Cable Specification

Cable Type	Range	Pixel Clock Rate	Video Data Rate	Supported Video Formats
CAT5E/6/7	100 M	≤225 MHZ	≤5.3 GBPS (HD VIDEO)	UP TO 1080P, 60HZ, 36-BIT, 3D (DATA RATES LOWER THAN 5.3GBPS OR BELOW 225MHZ TMDS CLOCK).
	70 M/ CAT5E/6 100 M/CAT7	>225 MHZ	>5.3GBPS (ULTRA HD VIDEO)	4K2K, 30HZ VIDEO FORMATS

8.2 Timing Support Chart

	HDMI INPUT	HDMI OUTPUT
480i/576i	x	✓
480p/576p	x	✓
640x480	✓	x
720p 50/60	x	✓
800x600	✓	x
1024x768	✓	x
1080i 50/60	x	✓
1080p 24/ 50/60	x	✓
1360x768	✓	x
1280x1024	✓	x
1600x1200	✓	x
1920x1200	✓	x

9. ACRONYMS

ACRONYM	COMPLETE TERM
CAT5e	Categirt 5 Cable
CAT6	Categirt 6 Cable
CAT7	Categirt 7 Cable
CEC	Consumer Electronics Control
DVI	Digital Visual Interface
HDCP	High-bandwidth Digital Content Proection
HDMI	High Definition Multimedia Interface
IR	Infrared
PD	Powered Device
PSE	Power Sourcing Equipment



CYP (UK) Ltd., Unit 7, Shepperton Business Park, Govett Avenue, Shepperton,
Middlesex, TW17 8BA

Tel: +44 (0) 20 3137 9180 | Fax: +44 (0) 20 3137 6279

Email: sales@cypeurope.com

www.cypeurope.com

v1.00