



4K UHD
HDCP 2.2



OR-44U-4K22

4 x 4 HDMI Matrix Switcher with USB Power Output
(4K, HDCP2.2, HDMI2.0)

OPERATION MANUAL

SAFETY PRECAUTIONS

Please read all instructions before attempting to unpack, install or operate this equipment and before connecting the power supply.

Please keep the following in mind as you unpack and install this equipment:

- Always follow basic safety precautions to reduce the risk of fire, electrical shock and injury to persons.
- To prevent fire or shock hazard, do not expose the unit to rain, moisture or install this product near water.
- Never spill liquid of any kind on or into this product.
- Never push an object of any kind into this product through any openings or empty slots in the unit, as you may damage parts inside the unit.
- Do not attach the power supply cabling to building surfaces.
- Use only the supplied power supply unit (PSU). Do not use the PSU if it is damaged.
- Do not allow anything to rest on the power cabling or allow any weight to be placed upon it or any person walk on it.
- To protect the unit from overheating, do not block any vents or openings in the unit housing that provide ventilation and allow for sufficient space for air to circulate around the unit.

REVISION HISTORY

VERSION NO.	DATE (DD/MM/YY)	SUMMARY OF CHANGE
RDV1	31/10/16	Preliminary Release

CONTENTS

1. Introduction	1
2. Applications	1
3. Package Contents	1
4. Package Contents	2
5. Features	2
6. Operation Controls and Functions	3
6.1 Front Panel	3
6.2 Rear Panel.....	5
6.3 Remote Control.....	6
6.4 LCD Menu Tree.....	7
6.5 IR Cable Assignments	7
6.6 RS-232 Protocol.....	8
6.7 RS-232 Command	9
6.8 Telnet Control	12
6.9 WebGUI	13
6.9.1 Switch	15
6.9.2 EDID Settings	18
6.9.3 System Setting	21
6.9.4 Admin log out.....	21
7. Connection Diagram	22
8. Specifications	23
8.1 Technical Specification.....	23
8.2 Support Timing	24
8.3 HDMI Cable Length	25

1. INTRODUCTION

This 4K UHD 4 by 4 Matrix provides the ability to connect up to four 4K UHD HDMI sources to up to four 4K UHD HDMI displays and freely switch between them. This unit comes with full support for 18Gbps (600Mhz) resolutions up to, and including 4K@60Hz (4:4:4, 8-bit) as well as support for 48-bit Deep Color, HDR (High Dynamic Range), HD audio and other features defined by the HDMI 2.0 specification. With a comprehensive EDID management feature that includes the ability to select between built in default EDID, EDID copied from connected sink devices, as well as a configurable EDID, this matrix can solve many interconnectivity problems. This unit also features four USB ports which supply up to 5V/1A power for use with connected optical fiber or AOC fiber cable extenders. By using these specialized cables your HDMI content can be extended much further than would be possible with normal HDMI cables. The built in OSD has the ability to display user editable general information text so each output can display up to 2 lines of customized text on top of the video source in the color of your choice. This unit provides an intuitive set of front panel controls with an OSD as well as RS-232, telnet, WebGUI, and IR remote control options.

2. APPLICATIONS

- Smart Home Control
- Control Center
- Function Room
- Product Showroom
- Ballroom

3. PACKAGE CONTENTS

- Matrix unit x 1
- 24V/3.75A Adaptor with power cord x 1
- Remote control unit x 1 (CR-177)
- Rack ear set x 1
- IR Receiver x 1
- Operation manual x 1

4. PACKAGE CONTENTS

- HDMI source equipment such as media players, video game consoles or set-top boxes.
- HDMI receiving equipment such as HDTVs, monitors or audio amplifiers.
- The use of "Premium High Speed HDMI" cables is highly recommended.

5. FEATURES

- HDMI input and output with 18Gbps (600MHz) 4K UHD support
- DVI 1.0 compliant with the use of an HDMI-DVI adaptor
- HDCP 1.4 and 2.2 compliant
- Supports HD resolutions up to 3840x2160@60 Hz (YUV 4:4:4, 8-bit) & 4096x2160@60 Hz (YUV 4:4:4, 8-bit)
- Supports 48-bit Deep Color up to 1080p60
- Supports pass-through of LPCM 7.1, bitstream and HD bitstream audio formats
- Supports six internal EDIDs, four external EDIDs copied from connected devices, and four user provided EDIDs
- Four USB ports to supply 5V/1A power to optical fiber and AOC fiber extension cables
- OSD with user customizable information text
- Intuitive control interface including telnet, WebGUI, OSD, IR remote and RS-232
- Easy firmware update via USB thumb drive in field

6. OPERATION CONTROLS AND FUNCTIONS

6.1 Front Panel

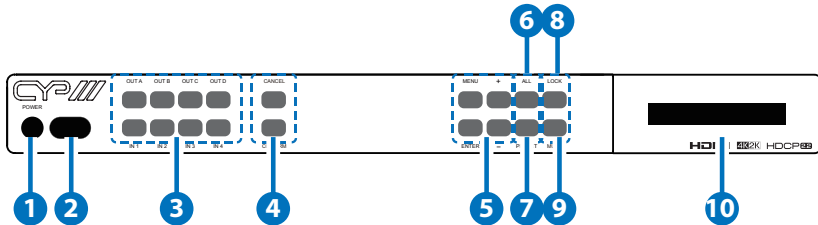

- 1 Power:** Press this button to power the unit on (green LED) or place it into stand-by mode (red LED).
- 2 IR Receiving Window:** Accepts IR signals from the included IR remote for control of this unit only.
- 3 IN 1~4 & OUT A~D:** Press the "OUT" keys (A~D) of the outputs you wish to route a source to (they will flash to indicate selection). Next, press the "IN" key of the input (1~4) you wish to route to the selected outputs. Finally, press "CONFIRM" to confirm your selection and execute the routing change.
- 4 CONFIRM:** Press this button to confirm newly made input/output routing selections.
CANCEL: Press this button to cancel newly made input/output/preset routing selections before they have been confirmed.
- 5 MENU:** Press to enter the LCD menu, or to back out from menu items.
ENTER: Press to confirm a selection within the LCD menu or to go deeper into a menu item.
- / +: Press to move up and down or adjust selections within menus.
- 6 ALL:** Press this button to select all outputs simultaneously for routing. Next, press the "IN" key of the input (1~4) you wish to route to all outputs. Finally, press "CONFIRM" to confirm your selection and execute the routing change.
- 7 PRESET:** Press to enter the preset recall menu in the LCD window. Press the "+/-" buttons followed by the "ENTER" button to select and activate the preferred preset.

- 8 **LOCK:** Press to lock all button functions on the front panel. Press and hold for 3 seconds to release the lock function. The LCD will display "Lock" when the function is active.
- 9 **MUTE:** The "MUTE" button functions as a blank audio/video source. To use it, follow the standard matrix routing instructions, but use the "MUTE" button as the input to blank out the selected outputs. When a "MUTE" input is in use it will show up as "M" within the routing display.
- 10 **LCD window:** Displays the unit's menu, settings and information.

6.2 Rear Panel

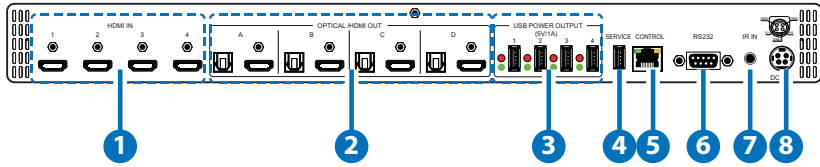

- 1 HDMI IN 1~4:** Connect to HDMI source equipment such as media players, game consoles or set-top boxes.
- 2 OPTICAL / HDMI OUT A~D:** Connect the HDMI outputs to devices such as HDMI TVs, monitors or amplifiers for digital video and audio output. Connect the optical outputs to powered speakers or amplifiers for digital audio output using an appropriate optical cable. The audio from each optical output will be the same as the HDMI output it is paired with.
- 3 USB POWER OUTPUT 1 ~ 4:** Each USB port provides 5v/1A of power intended for use with HDMI over AOC (Active Optical Cables) fiber optic video extension cables.
- 4 SERVICE:** This slot is reserved for firmware update use only.
- 5 CONTROL:** Connect directly, or through a network switch, to your PC/laptop to control the unit via telnet/WebGUI.
- 6 RS232:** Connect directly to a PC, laptop or other serial control device to send RS-232 commands to control the unit.
- 7 IR IN:** Connect to the provided IR Extender to extend the IR control range of the unit. Ensure that the remote being used is within direct line-of-sight of the IR Extender.
- 8 DC 24V:** Plug the 24V DC power adapter into the unit and connect it to an AC wall outlet for power.

6.3 Remote Control

- 1 POWER:** Press to power the unit on or place it into stand-by mode.
- 2 1/A ~ 4/D:** Press these keys to configure the video routing. Press the "OUT" key followed by the key (A~D) of the outputs you wish to route a source to (they will flash to indicate selection). Next, press the "IN" key followed by the input (1~4) you wish to route to the selected outputs. Finally, press "ENTER" to confirm your selection and execute the routing change.

Note: Keys 5/E ~ 8/H have no function with this matrix.

- 3 ALL:** Press this key to select all outputs simultaneously for routing. Next, press the key of the input (1~4) you wish to route to all outputs. Finally, press "ENTER" to confirm your selection and execute the routing change.

MUTE: Press this key to mute video output. Press the key of the input (1~4) you wish to route then press mute key to mute video output.

INFO: Switches the information displayed on each output's OSD between the user customized text and the current video/Ethernet details.

PRESET: Press to enter the preset call menu in the LCD window. Press the "+/-" buttons followed by the "ENTER" button to select and activate the preferred preset.

- 4 a. MENU:** Press to enter the LCD menu, or to back out from menu items.
b. ENTER: Press to confirm a selection within the LCD menu or to go deeper into a menu item.
c. CANCEL: Press to cancel newly made input/output/preset routing selections before they have been confirmed.
d. Plus (+) / IN: Press "+/IN" to navigate up within menus or to begin the selection of an input for routing.
e. Minus (-) / OUT: Press "-/OUT" to navigate down within menus or to begin the selection of outputs for routing.

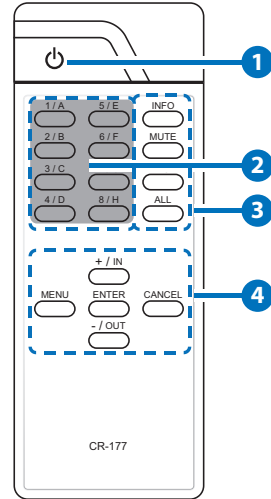

6.4 LCD Menu Tree

1 st Level	2 nd Level
EDID	In1 / In2 / In3 / In 4 / In All
Preset Setup	1/2/3/4
Network Status	Link (Valid) / Mode (Static/DHCP)/ IP/Mask/Gate/MAC
Network Setup	Mode: (Static/DHCP)
Static: IP/Mask/Gate	
Firmware	Version
Firmware Update	USB update
Factory Reset	Factory reset

6.5 IR Cable Assignments

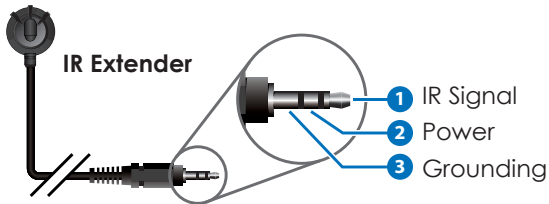

6.6 RS-232 Protocol

MATRIX			REMOTE CONTROLLER	
Pin	Assignment		Pin	Define TX / RX
1	NC		1	NC
2	TX		2	RX
3	RX	▶	3	TX
4	NC		4	NC
5	GND	◀	5	GND
6	NC		6	NC
7	NC		7	NC
8	NC		8	NC
9	NC		9	NC

Baud Rate: 115200bps

Data Bits: 8

Parity: None

Flow Control: None

Stop Bits: 1

6.7 RS-232 Command

Command Name	Description	Description of parameter
?	Show descript of command.	? command
HELP	Show descript of command.	? command
ETH_FADEFULT	All Ethernet configure set to factory default.	NONE
SIPMODE	Set Ethernet IP mode.	SIPMODE P P=Mode(STATIC/DHCP)
SETIP	Set Ethernet IP address, subnet mask, gateway.	SETIP P1 P2 P3 P1=IPADDRESS P2=NETMASK P3=GATEWAY (P1~P3)=X.X.X.X (X=0~255)
IPCONFIG	Display the current IP configuration	NONE
REBOOT	System reset	NONE
QUIT	Telnet QUIT	NONE
P0	Power off.	NONE
P1	Power on.	NONE
STORE	Store current I/O position	STORE P P=Port(1~4)
SHOW	Show current port's I/O position	STORE P P=Port(1~4)
PRESET	Preset the store I/O position	PRESET P P=Port(1~4)
NAME	Set Preset name	NAME NAME P1 P2 P1=Port(1~4) P2=Name(1~8 Charactors)
I	Set all outputs source	IP P=Input Port(1~4)
ST	Show firmware version	NONE

Command Name	Description	Description of parameter
RS	System Reset to A1,B2,C3,D4.	NONE
EM	Setting EDID mode.	EM P1 P2 P1=PORT(1~4) P2=(1-FHD2CH, 2-FHD-MCH, 3-4KUHD2CH, 4-4KUHD-DMCH, 5-4KUHD+2CH, 6-4KUHD+MCH, 7-TXA,8-TXB, 9-TXC,10-TXD, 11-USER1, 12-USER2, 13-USER3, 14-USER4)
UPDATE	Update firmware by SERVICE USB port. note:Device will wating for the USB device plug in or power cycle to reboot.	NONE
A	Set output A source.	AP P=Input Port(1~4)
B	Set output B source.	BP P=Input Port (1~4)
C	Set output C source.	CP P=Input Port (1~4)
D	Set output D source.	DP P=Input Port (1~4)
AB..	Set output ABCD... source at the same time.	AB..P P=Input Port (1~4)
USEREDID	Set user EDID name.	USEREDID P1 P2 P1=Port(1~4) P2=Name(1~8 Characters)
FADEFAULT	All configure set to factory default.	NONE
OSDON	OSD on.	OSDON P P=Output Port(1~4)

Command Name	Description	Description of parameter
OSDOFF	OSD off.	OSDOFF P P=Output Port(1~4)
OSDXY	Set OSD coordinate.	OSDXY P1 P2 P3 P1=Output Port(1~4) P2=x(1~1920) P3=y(1~1080)
OSDSTR	Set OSD string.	OSDSTR P1 P2 P3 P1=Output Port(1~4) P2=Line(1~2) P3=String(1~64 Characters)
OSDFSIZE	Set OSD font size.	OSDFSIZE P1 P2 P1=Output Port(1~4) P2=Size(1~3)
OSDFCOLOR	Set OSD font color.	OSDFCOLOR P1 P2 P1=Output Port(1~4) P2=Font Color(1~9)
OSDBGCOLOR	Set OSD background color.	OSDBGCOLOR P1 P2 P1=Output Port(1~4) P2=Background Color(1~9)
OSDTS	Set OSD background transparent level.	OSDTS P1 P2 P1=Output Port(1~4) P2=Transparent Level(1~8)
OSDINFO	Set OSD information on off.	OSDINFO P P=Action(ON/OFF)
ROSDINFO	Get OSD information status.	NONE
USBPWR	USB power on/off.	USBPWR P1 P2 P1=Output Port(1~4) P2=Action(ON/OFF)

6.8 Telnet Control

Before attempting to use telnet control, please ensure that both the unit and the PC/Laptop are connected to the same active networks.

To access Telnet in Windows 7, click on the "Start" menu and type "cmd" in the search field, then press "Enter".

Under Windows XP go to the "Start" menu, click on "Run", type "cmd" then press "Enter".

Under Mac OS X, go to Go→Applications→Utilities→Terminal

See below for reference.

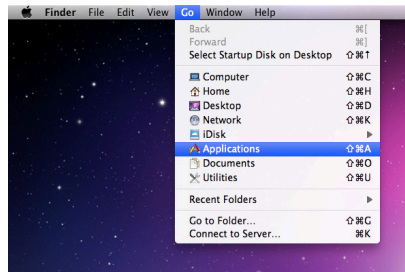
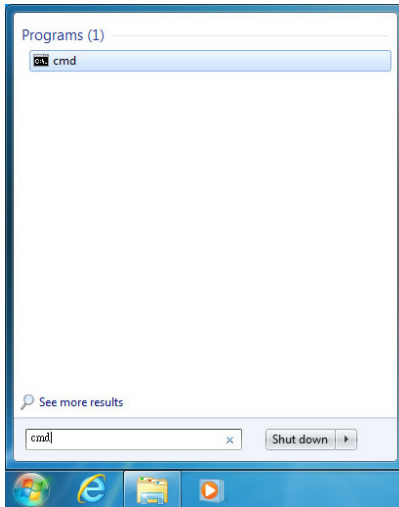

Once in the CLI (Command Line Interface) type "telnet" followed by the IP address of the unit and "23", then hit "Enter".

```
Microsoft Windows [Version 6.1.7601]
Copyright (c) 2009 Microsoft Corporation. All rights reserved.

C:\Users\Administrator>telnet 192.168.XX.XX 23
```

This will connect us to the unit we wish to control. Type “help” to list the available commands.

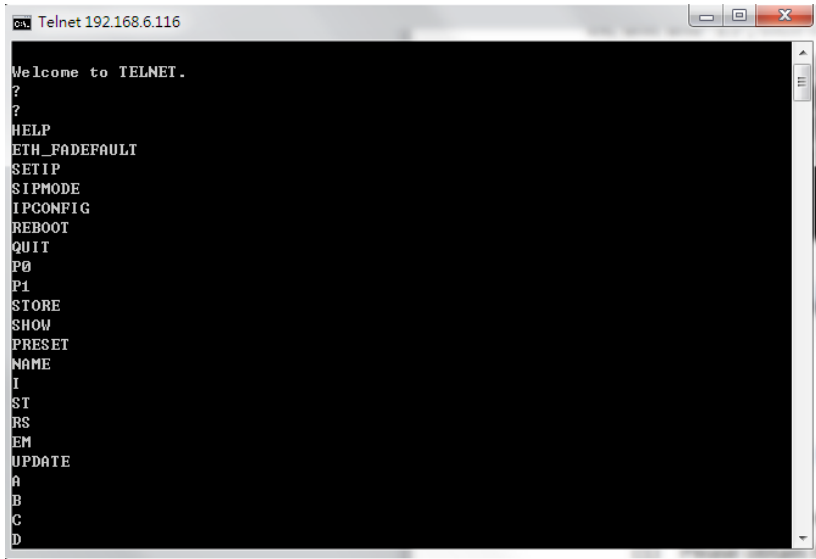

```
ca> Telnet 192.168.6.116

Welcome to TELNET .
?
?
HELP
ETH_FADEFAULT
SETIP
SIPMODE
IPCONFIG
REBOOT
QUIT
P0
P1
STORE
SHOW
PRESET
NAME
I
ST
BS
EM
UPDATE
A
B
C
D
```

6.9 WebGUI

Install the IP Discovery Tool:

- (1) Please obtain the Device Discovery software from your authorized dealer and save it in a directory where you can easily find it.
Note: The unit's default IP address is 192.168.1.50
- (2) Connect the unit and your PC/Laptop to the same active network and execute the Device Discovery software. Click on “Find Devices on Network” and a list of devices connected to the local network will show up indicating their current IP address.

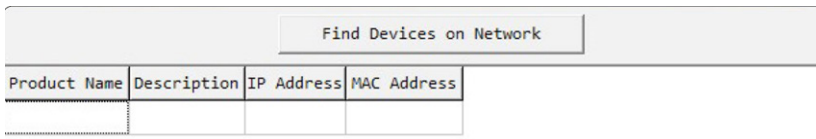

Find Devices on Network			
Product Name	Description	IP Address	MAC Address

- (3) By clicking on one of the listed devices you will be presented with the network details of that particular device. If you choose, you can alter the static IP network settings for the device, or

switch the unit into DHCP mode to automatically obtain proper network settings from a local DHCP server. To switch to DHCP mode, please select DHCP from the IP mode drop-down, then click "Save" followed by "Reboot".

The screenshot shows a network configuration window with the following fields and values:

- Product ID
- Product Name
- MAC Address: 00:00:00:00:00:00
- IP Address: [Empty text box]
- Subnet Mask: [Empty text box]
- Gateway IP: [Empty text box]
- DNS: [Empty text box]
- IP Mode: Static (dropdown menu)
- Web GUI Port: 0
- Telnet Port: 0
- S / N
- Firmware Version
- Hardware Version
- Description
- Web GUI: [Web GUI](#)

At the bottom of the window are two buttons: "Save" and "Reboot".

- (4) Once you are satisfied with the network settings, you may use them to connect via telnet or WebGUI. The network information window provides a convenient link to launch the WebGUI directly.

- **Login to the WebGUI:**

- (1) By default, both the Username and Password are "admin" for the WebGUI. The administrator password can be changed within the "System Settings" tab of the WebGUI if desired.

A login form with a dark grey header containing the word "Login" in white. Below the header, there are two input fields: "Username" and "Password". The "Username" field contains a single vertical bar character. Below the input fields is a "Submit" button.

- (2) The following function tabs will always display on left side of the WebGUI to aid with navigation.

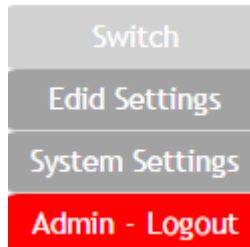

6.9.1 Switch

This page provides video routing settings, preset saving/loading, and I/O renaming options.

- **Video Routing**

To begin assigning a new video route, please click the button of the HDMI output you wish to send video to and then click on the button of the preferred HDMI input port. If desired, you may select more than one output prior to selecting the input. As you select each button they will change their color to orange. The new route will become active immediately after selecting the input port and the routing information displayed on the buttons will change accordingly.

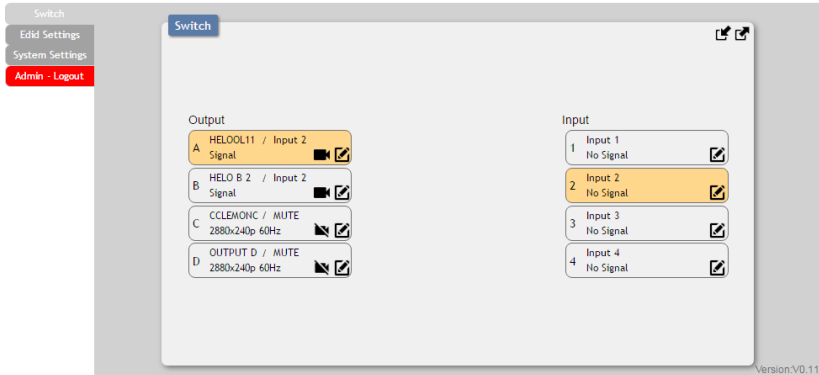

- **Output Video Mute**

Each output can be individually muted (black video, no audio). To mute an output, please click the (🔇) icon within the appropriate output button. To unmute the output, please click the icon a second time.

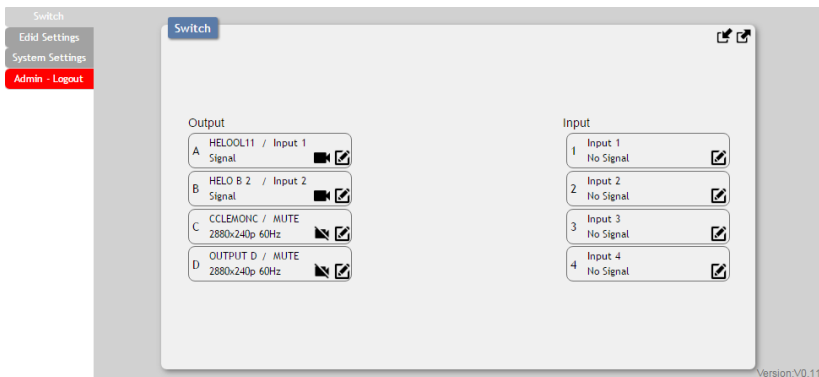

- **Output and Input Naming**

All inputs and outputs can be renamed as required. To rename the input and output ports please click the “edit” icon (✎).

Click the “Save” button to confirm the change.

Note: Blank spaces (“ ”) are not allowed in names.

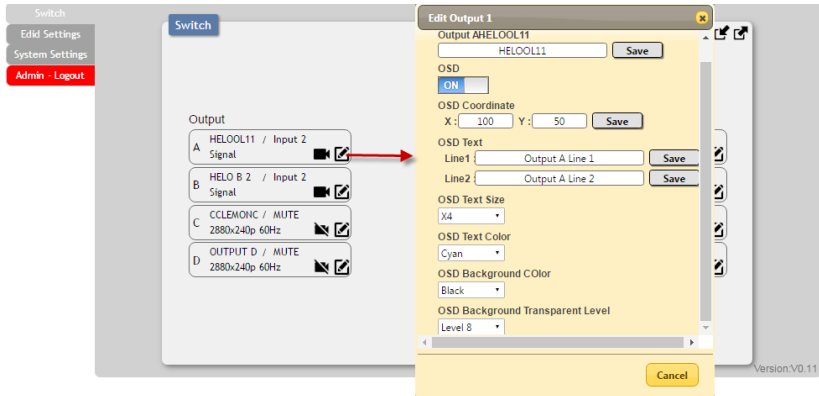

- **OSD Text Settings**

Each output can display up to 2 lines of customized OSD text. The text can be customized in content, color, background transparency, size and position. Click the “edit” icon (📄) associated with each output to modify these settings. Please click the “Save” button after making changes to the positioning or content. All other changes occur as soon as they are made.

- **Preset Setting**

This matrix can store up to four video routing presets. Presets can be utilized to store multiple different routing states in advance for rapid, hassle-free, recall.

- **Store:** Once you have the matrix set the way you like, you can click the “Preset Set” icon (📌) in the upper right corner of the window and the Preset Set window will open. You may also name the preset at this stage by selecting the “edit” icon (📄). Click the main part of the Preset’s button to store the current state into that preset.

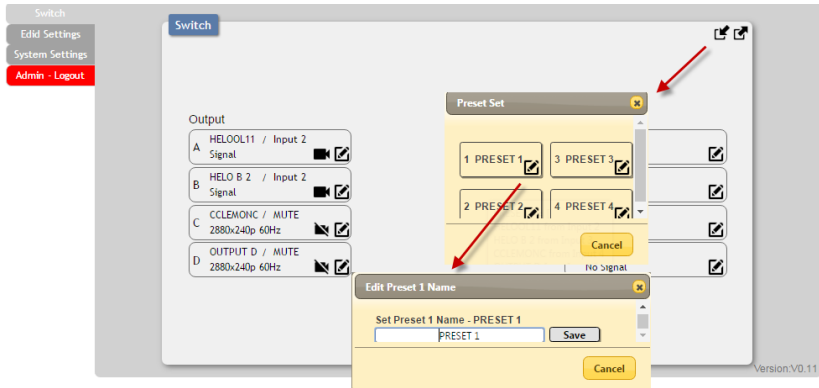

- Recall:** When you wish to load a previously stored preset, please click the “Preset Recall” icon () and you will be presented with a choice of the available 4 presets. Hovering the mouse over each button will display the preset routes stored within it. The preset will load immediately upon selecting the preset.

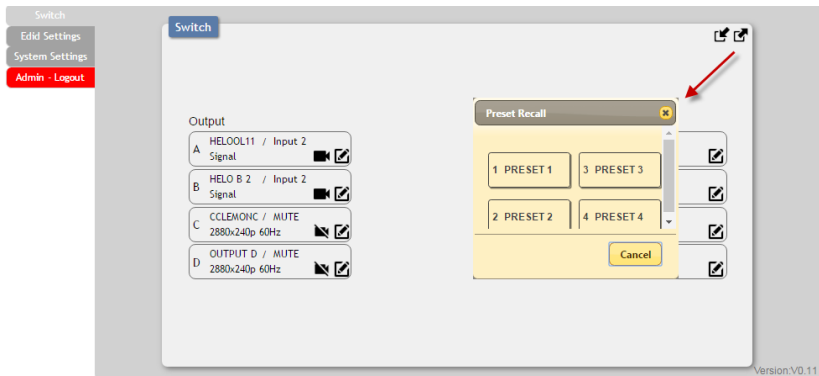

6.9.2 EDID Settings

This matrix provides the option of six standard EDIDs, four sink sourced EDIDs and four customer uploaded EDIDs that can be assigned to each input port individually. The names of the four customer uploaded EDIDs can be changed if desired.

- Customer EDID Settings**

To upload a custom EDID, please click the “Upload” button next

to the Customer EDID Settings item you would like to change. An EDID Upload window will appear, allowing you to locate and upload your preferred EDID file from the file directory on your local PC. Once the correct file has been selected, please click the "Upload" button in the window, and the file will be transferred to the matrix.

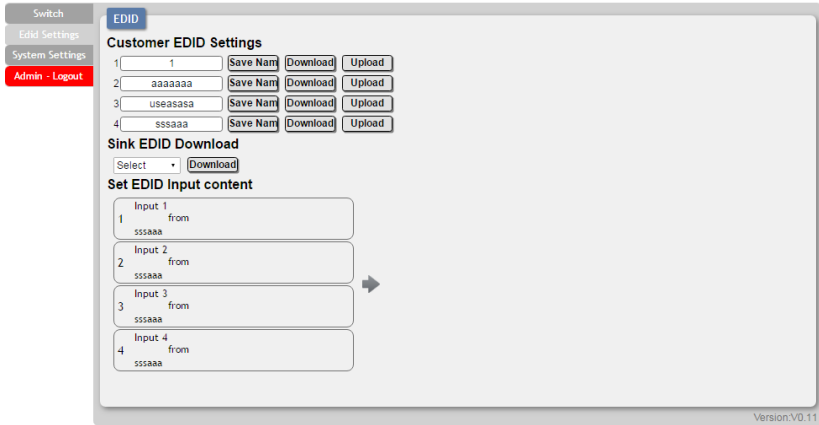

- **Sink EDID Download**

To save an existing custom EDID to your local PC please press the "Download" button next to the Customer EDID Settings item you would like to save. Depending on your browser settings you will either be asked where to save the downloaded file, or the file will be transferred to the default download location on your PC.

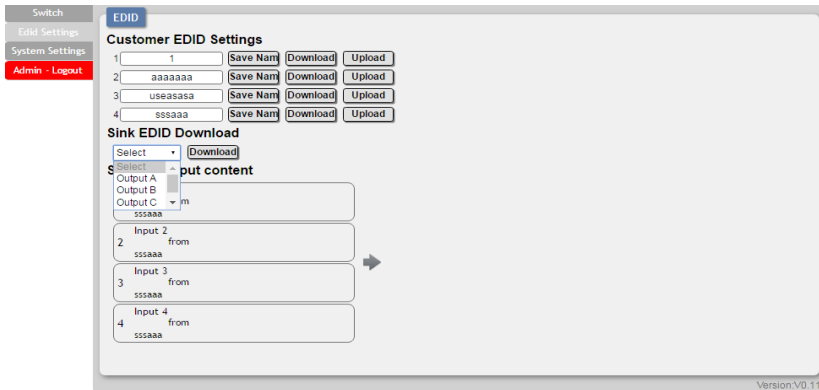

● Set EDID Input Content

The Set EDID Input Content section allows for the assignment of an EDID to each individual input port, or to all inputs at once. Click on an input to open the EDID Source management window. Multiple inputs can be selected at once, if desired. Select the new EDID source to use and the change will occur immediately.

The screenshot shows a web interface for EDID configuration. On the left, there is a navigation menu with 'Switch', 'Edid Settings', 'System Settings', and 'Admin - Logout'. The main content area is titled 'EDID' and contains the following sections:

- Customer EDID Settings:** A table with 4 rows. Each row has an input field, a 'Save Name' button, a 'Download' button, and an 'Upload' button.

1	1	Save Name	Download	Upload
2	aaaaaaa	Save Name	Download	Upload
3	useasasa	Save Name	Download	Upload
4	ssssaaa	Save Name	Download	Upload
- Sink EDID Download:** A dropdown menu labeled 'Select' and a 'Download' button.
- Set EDID Input content:** A list of 4 input items. Each item has a number, an 'Input' label, a 'from' label, and a text field. Item 1 is highlighted in orange.

1	Input 1	from	ssssaaa
2	Input 2	from	ssssaaa
3	Input 3	from	ssssaaa
4	Input 4	from	ssssaaa
- Edid Source:** A table with 6 rows. Each row has a source type, a sink label, and a text field.

8bit2D/PCM/1080p/2CH	Sink A	useasasa
8bit2D/PCM/1080p/MCH	Sink B	ssssaaa
8bit2D/PCM/4K2K@30/2CH	Sink C	
8bit2D/PCM/4K2K@30/MCH	Sink D	
8bit2D/PCM/4K2K@60/2CH	1	
8bit2D/PCM/4K2K@60/MCH	aaaaaaa	

Version: V0.1.1

Note: This matrix comes with the following 6 default EDIDs:

1. FHD/2CH: 1080p@60Hz(148MHz), LPCM 2.0, 8-bit color
2. FHD/MCH: 1080p@60Hz(148MHz), LPCM 7.1 & bitstream, 8-bit color.
3. 4K UHD/2CH : 3840×2160p@30Hz (297MHz), LPCM 2.0, Deep Color (8/10/12-bit)
4. 4K UHD / MCH : 3840×2160p@30Hz (297MHz), LPCM 7.1 & bit-stream, Deep Color (8/10/12-bit)
5. 4K UHD+ / 2Ch : 3840×2160p@60Hz (594MHz), LPCM 2.0, Deep Color (8/10/12-bit)
6. 4K UHD+ / MCH : 3840×2160p@60Hz (594MHz), LPCM 7.1 & bit-stream, Deep Color (8/10/12-bit)

Note: In some rare cases it is possible for custom or external EDIDs to cause compatibility issues with certain sources. If this happens, it is recommended to switch to one of the 6 default EDIDs for maximum compatibility.

6.9.3 System Setting

This page provides system configuration options including turning the unit's power on/off, turning the USB power support on/off, changing the network settings, resetting the system to factory defaults and updating the firmware.

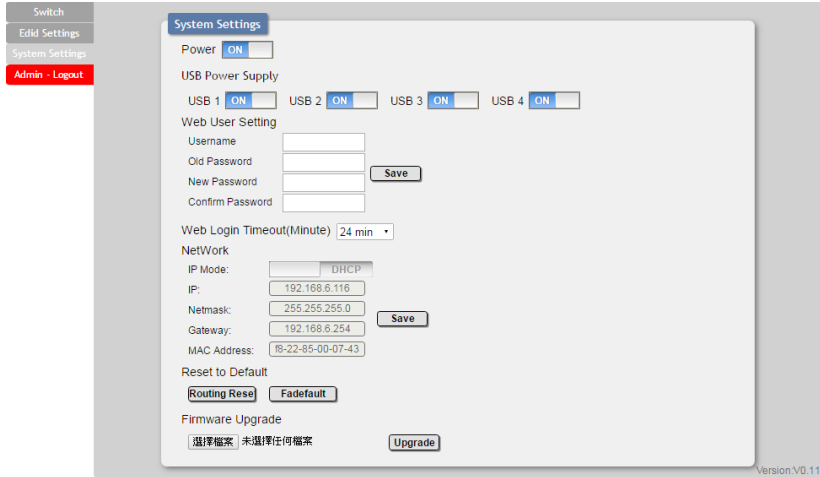

6.9.4 Admin log out

Clicking the “Logout” tab will automatically log the user out of the WebGUI and return to login page.

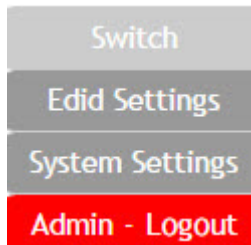

7. CONNECTION DIAGRAM

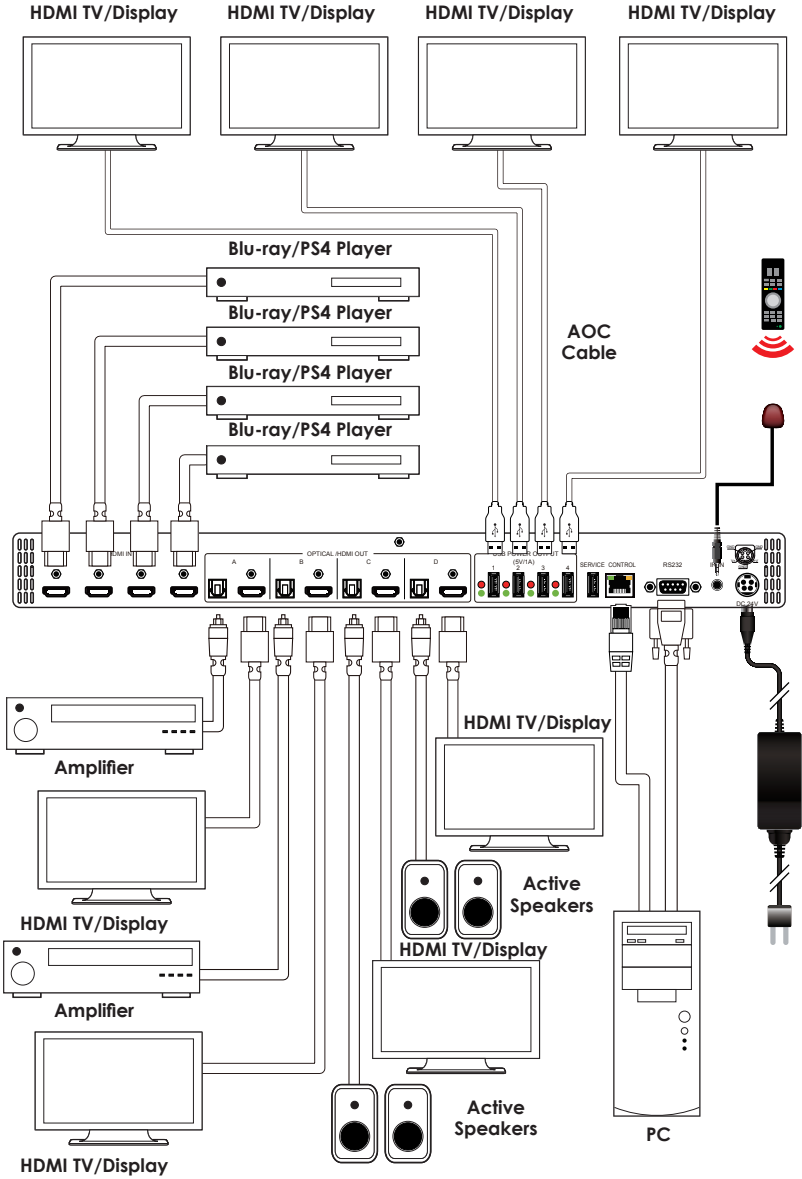

8. SPECIFICATIONS

8.1 Technical Specification

Video Bandwidth	18Gbps (600Mhz)
Input Ports	4 x HDMI
Control Interfaces	1 x IR In 1 x RS-232 1 x Service (USB) 1 x Control
Output Ports	4 x HDMI 4 x USB port (5V/1A power supply)
Supported Resolutions	480i~4K@24/50/60Hz 4K@50/60Hz VGA~WUXGA
IR Frequency	38kHz
Baud Rate	115200 bps
Power Supply	24VDC/3.75A (US/EU standards, CE/FCC/ UL certified)
Chassis Material	Metal
Color	Black
Dimensions	438mm x 49mm x 269mm (W×H×D) [Case Only] 482mm x 49mm x 274mm (W×H×D) [All Inclusive]
Weight	2966g

8.2 Support Timing

Input & output / Timing (Hz)	HDMI Input	HDMI Output
640x480@60/72/75/85	√	√
720x400@85	√	√
720x480p@59.94/60	√	√
720x576p@50	√	√
800x600@56/60/72/75/85	√	√
1024x768@60/70/75/85	√	√
1152x864@75	√	√
1280x720p@50/59.94/60	√	√
1280x768@60/75	√	√
1280x800@60RB/60	√	√
1280x960@60	√	√
1280x1024@60	√	√
1360x768@60	√	√
1366x768@60	√	√
1440x480i@59.94/60	√	√
1440x576i@50	√	√
1400x1050@60RB/60	√	√
1440x900@60RB/60	√	√
1600x900@60	√	√
1600x1200@60	√	√
1680x1050@60RB/60	√	√
1920x1080@60RB	√	√
1920x1080i@60	√	√
1920x1080p@23.97/24/25/29.97/30/59.94/60	√	√
3840x2160p@24/25/30	√	√
3840x2160@50/60(4:4:4)/50/60(4:2:0)	√	√
4096x2160p@24	√	√

8.3 HDMI Cable Length

Timing	Input	Output
1080p	10M	10M
4k2k@30	10M	10M
4k2k@60 (certified HDMI cable)	3M	10M



CYP (UK) Ltd., Unit 7, Shepperton Business Park, Govett Avenue, Shepperton,
Middlesex, TW17 8BA

Tel: +44 (0) 20 3137 9180 | Fax: +44 (0) 20 3137 6279

Email: sales@cypeurope.com

www.cypeurope.com

RDV1