



**4K2K**

**HDCP 2.2**



# EL-8500VA

**9 x 2 Multi-format Presentation Scaler with HDBT**

**OPERATION MANUAL**



## **DISCLAIMERS**

The information in this manual has been carefully checked and is believed to be accurate. CYP (UK) Ltd assumes no responsibility for any infringements of patents or other rights of third parties which may result from its use.

CYP (UK) Ltd assumes no responsibility for any inaccuracies that may be contained in this document. CYP (UK) Ltd also makes no commitment to update or to keep current the information contained in this document.

CYP (UK) Ltd reserves the right to make improvements to this document and/or product at any time and without notice.

## **COPYRIGHT NOTICE**

No part of this document may be reproduced, transmitted, transcribed, stored in a retrieval system, or any of its part translated into any language or computer file, in any form or by any means—electronic, mechanical, magnetic, optical, chemical, manual, or otherwise—without express written permission and consent from CYP (UK) Ltd.

© Copyright 2019 by CYP (UK) Ltd.

All Rights Reserved.

Version 1.1

## **TRADEMARK ACKNOWLEDGMENTS**

All products or service names mentioned in this document may be trademarks of the companies with which they are associated.

## SAFETY PRECAUTIONS

Please read all instructions before attempting to unpack, install or operate this equipment and before connecting the power supply.

Please keep the following in mind as you unpack and install this equipment:

- Always follow basic safety precautions to reduce the risk of fire, electrical shock and injury to persons.
- To prevent fire or shock hazard, do not expose the unit to rain, moisture or install this product near water.
- Never spill liquid of any kind on or into this product.
- Never push an object of any kind into this product through any openings or empty slots in the unit, as you may damage parts inside the unit.
- Do not attach the power supply cabling to building surfaces.
- Use only the supplied power supply unit (PSU). Do not use the PSU if it is damaged.
- Do not allow anything to rest on the power cabling or allow any weight to be placed upon it or any person walk on it.
- To protect the unit from overheating, do not block any vents or openings in the unit housing that provide ventilation and allow for sufficient space for air to circulate around the unit.

## REVISION HISTORY

VERSION NO.	DATE	SUMMARY OF CHANGE
v1.00	15/10/2019	First release

# CONTENTS

<b>1. Introduction</b> .....	<b>6</b>
<b>2. Applications</b> .....	<b>6</b>
<b>3. Package Contents</b> .....	<b>7</b>
<b>4. System Requirements</b> .....	<b>7</b>
<b>5. Features</b> .....	<b>8</b>
<b>6. Operation Controls and Functions</b> .....	<b>9</b>
6.1 Front Panel .....	9
6.2 Rear Panel .....	10
6.3 IR Cable Pinouts .....	13
6.4 RS-232 Pinout and Defaults .....	13
6.5 OSD Menu .....	14
6.6 WebGUI Control .....	33
6.7 Telnet Control .....	47
6.8 Serial and Telnet Commands .....	48
<b>7. Connection Diagram</b> .....	<b>73</b>
<b>8. Specifications</b> .....	<b>74</b>
8.1 Technical Specifications .....	74
8.2 Video Specifications .....	76
8.3 Audio Specifications .....	80
8.4 Cable Specifications .....	82
8.5 HDBaseT Features .....	83
<b>9. Acronyms</b> .....	<b>84</b>

## 1. INTRODUCTION

This 9 by 2 multi-format scaling switcher provides HDMI, USB-C, HDBaseT, and VGA inputs which can be freely selected for output at a scaled resolution of the user's choosing over the mirrored HDMI and HDBaseT outputs. The HDMI and USB-C ports support resolutions up to 4K@60 (4:4:4, 8-bit) while the HDBaseT output supports automatic colour subsampling of 4K50/60(4:4:4) sources to 4K50/60(4:2:0). The VGA inputs support resolutions up to WUXGA. The HDBaseT output provides a great solution to extend your audio and video up to 100 metres over a single run of Cat.6A cable as well as providing PoH power to compatible HDBaseT Transmitters and Receivers.

This unit also includes multiple analogue stereo audio inputs and a microphone input along with an amplified analogue stereo output to provide a range of audio routing and mixing flexibility. The built-in audio mixer function allows the user to mix audio from any LPCM 2.0 source with the microphone input for presentation or lecture usage. The ability to switch back and forth between mixed and non-mixed audio greatly simplifies the presentation experience.

A trigger input interface is also provided to allow the easy addition of a remote control keypad, or other trigger-supporting products, which can be installed within a podium or within a table in a conference room or classroom. This interface can allow the user to activate functions with the simple press of a button. Standard control is available via front panel buttons with an On-Screen Display (OSD), WebGUI, Telnet, and RS-232 making it exceptionally versatile.

## 2. APPLICATIONS

- /// Lecture room display and control
- /// Showroom display and control
- /// Meeting room presentation and control
- /// Classroom display and control

### **3. PACKAGE CONTENTS**

- /// 1× HDMI/HDBaseT/USB-C/VGA to HDMI/HDBaseT Scaler
- /// 1× 24V/6.25A DC Power Adapter
- /// 1× 3.5mm to IR Blaster Cable
- /// 1× 3.5mm to IR Extender cable
- /// 1× Shockproof Feet (Set of 4)
- /// 1× Operation Manual

### **4. SYSTEM REQUIREMENTS**

- /// HDMI/USB-C source equipment such as media players, video game consoles or set-top boxes.
- /// VGA source equipment such as PCs, laptops or set-top boxes.
- /// HDMI receiving equipment such as an HDTV, monitor or audio amplifier.
- /// Analogue audio receiving equipment such as audio amplifiers or powered speakers.
- /// Compatible HDBaseT transmitters and receiver with PoH support is recommended.
- /// The use of Premium High Speed HDMI cables, and industry standard Cat.6, Cat.6A or Cat.7 cables is highly recommended.

## 5. FEATURES

- /// HDMI 2.0 and DVI 1.0 compliant
- /// HDCP 1.x and 2.2 compliant
- /// 9 video inputs (1×USB-C, 2×HDBaseT, 4×HDMI, 2×VGA)
- /// 2 mirrored video outputs (1×HDMI, 1×HDBaseT)
- /// Supports switching and scaling of all AV inputs for display over the mirrored HDMI and HDBaseT outputs
- /// Supports up to 4K UHD (18Gbps, 4K@50/60Hz 4:4:4, 8-bit) digital video input (HDMI, USB-C) and output (HDMI)
- /// VGA input supports resolutions up to 1080p60/WUXGA (RB)
- /// HDBaseT output supports resolutions up to 4K@60Hz (4:2:0, 8-bit) or 4K@30Hz (4:4:4, 8-bit). 4K@50/60Hz (4:4:4, 8-bit) or 4K@any (10/12-bit) sources will be automatically colour space converted to fit within the available bandwidth
- /// Supports Deep Colour input and output up to 12-bit (Bypass only)
- /// Supports 10-bit and 12-bit HDR (High Dynamic Range) input/output (HDMI Bypass only)
- /// HDBaseT inputs/output extend video, audio, and data over a single Cat.5e/6/7 cable and can reach distances up to 100m/328ft at 4K when using Cat.6a/7
- /// Supports pass-through of many audio formats including LPCM (up to 8 channels), Bitstream and HD Bitstream
- /// Audio mixer function allows the mixing of audio from any LPCM 2.0 audio source with the microphone input
- /// Trigger Control Keypad support for easy, single-button, function activation (Optional)
- /// Supports standard PoH (PSE) from the HDBaseT output and HDBaseT inputs to connected HDBaseT (PD) transmitters and receiver (compatible transmitters/receivers only)
- /// Comprehensive EDID and HDCP management
- /// Controllable via front panel controls with OSD, RS-232, Telnet, WebGUI, and triggers



## 6. OPERATION CONTROLS AND FUNCTIONS

### 6.1 Front Panel

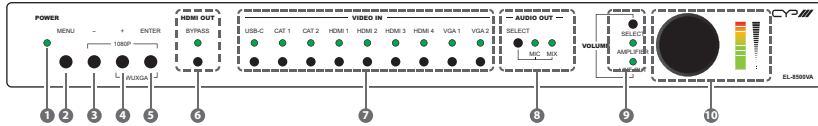

- 1 POWER LED:** This LED will illuminate to indicate the unit is on and receiving power.
- 2 MENU Button:** Press to enter the OSD menu, or to back out from menu items.
- 3 MINUS (-) Button:** Press to move down or adjust selections within OSD menus.
- 4 PLUS (+) Button:** Press to move up or adjust selections within OSD menus.

*Note: Pressing the “+” button when not in a menu will toggle the video freeze feature.*
- 5 ENTER Button:** Press to confirm a selection within the OSD or to go deeper into a menu item.

*Note: Pressing “ENTER” and “+” together will reset the output resolution to WUXGA (1920×1200@60Hz). Pressing “ENTER” and “-” together will reset the output resolution to 1080p@60Hz.*
- 6 HDMI OUT BYPASS Button & LED:** Press this button to enable or disable the HDMI video Bypass function. When bypass is enabled, the LED will illuminate.
- 7 VIDEO IN Buttons & LEDs:** Press any of these buttons to switch immediately to the corresponding input. An LED will illuminate to indicate which source is currently selected.
- 8 AUDIO OUT SELECT Button & LEDs:** Press this button to select the microphone mix mode of the unit. The LED will illuminate to indicate the current mix mode. When both LEDs are off, the mixer is disabled.

*Note: Activating Mixer On mode or MIC Only mode will automatically disable HDMI Out Bypass mode.*
- 9 VOL. Button & LEDs:** Press this button to select which audio output’s volume is controlled by the volume knob. When both LEDs are off, the

knob controls the HDMI audio output (LPCM 2.0 only).

- 10 **VOL. Rotary Knob & LEDs:** Rotating the knob increases or decreases the currently selected audio output's volume level. The LED bar will change according to the current level. Pressing in on the knob toggles the audio mute function.

## 6.2 Rear Panel

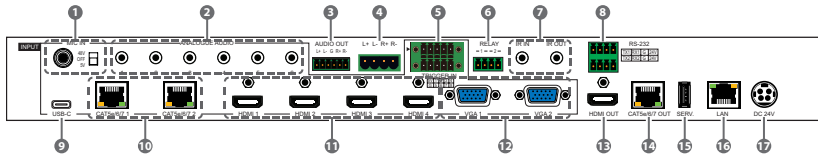

- 1 **MIC IN Port & 48V/OFF/5V Switch:** Connect to a standard microphone using a 6.35mm plug. Set the switch based on the phantom power requirements of the connected microphone.  
*Note: If no phantom power is required, this switch should remain in the "Off" position to avoid potential damage to connected equipment.*
- 2 **Analogue AUDIO INPUT 1~6 Ports:** Connect to the analogue stereo output of a device such as an audio player or PC.  
*Note: By default, Analogue Audio 1 is paired with VGA input 1 and Analogue Audio 2 is paired with VGA input 2.*
- 3 **AUDIO OUT 5-pin Terminal Block:** Connect to powered speakers or an amplifier for analogue stereo audio output.
- 4 **AUDIO OUT L/R 2-pin Terminal Blocks:** Connect to unpowered 4Ω speakers for analogue stereo audio output. Up to 20W of power is provided to each speaker.
- 5 **TRIGGER IN 10-pin Terminal Block:** Connect to the Trigger Control Keypad (Optional) or any device with trigger switch functionality such as window security alarms, motion detectors, door switches, etc. Each of the 8 triggers will activate an assigned unit function when triggered.  
*Note: A minimum of 5V DC is required to activate a trigger.*

- ⑥ **RELAY 1~2 2-pin Terminal Blocks:** Connect to devices that can be powered and controlled via a DC 0~24V/5A relay connection such as a curtain, projection screen, or lights.
- ⑦ **IR IN Port:** Connect to an IR Extender to receive local IR control signals and extend them to devices connected to the other end of the HDBaseT connection. Ensure that the remote being used is within direct line-of-sight of the IR Extender.

**IR OUT Port:** Connect to an IR Blaster to transmit IR signals from the other end of the HDBaseT connection to devices within direct line-of-sight of the IR Blaster.

*Note: IR can only be routed across a single HDBaseT connection at a time. The HDBaseT connection to use is defined within the WebGUI or OSD menu.*

- ⑧ **RS-232 1 4-pin Terminal Block 1 (Top):** Connect directly to a PC, laptop, or other serial control device with a 3-pin adapter cable to send RS-232 commands to control the unit.

*Note: The 24 volt pins are included to provide power to a dedicated external control product and should NOT be used when connecting a standard RS-232 device.*

**RS-232 2 4-pin Terminal Block (Bottom):** Connect to a PC, laptop, or serial controllable device with a 3-pin adapter cable for the extension of RS-232 signals between this unit and the designated HDBaseT connection.

*Note: RS-232 can only be routed across a single HDBaseT connection at a time. The HDBaseT connection to use is defined within the WebGUI or OSD menu.*

- ⑨ **USB-C INPUT Port:** Connect to USB Type-C video source equipment such as a PC or laptop.
- Note: Not all devices with USB Type-C ports can support video output. Please verify that the device supports video output from the USB Type-C port before connecting it.*

- ⑩ **CAT5e/6/7 INPUT 1~2 Ports:** Connect to compatible HDBaseT transmitters with a single Cat.5e/6/7 cable for reception of all data signals. PoH will also be supplied to connected compatible PD transmitters.

- ⑪ **HDMI INPUT 1~4 Ports:** Connect to HDMI source equipment such as media players, game consoles, or set-top boxes. DVI sources are supported with the use of an HDMI to DVI adapter.
- ⑫ **VGA INPUT 1~2 Ports:** Connect to VGA source equipment such as PCs or laptops.
- ⑬ **HDMI OUT Port:** Connect to an HDMI TV, monitor, or amplifier for digital video and audio output.
- ⑭ **CAT5e/6/7 OUT Port:** Connect to a compatible HDBaseT receiver with a single Cat.5e/6/7 cable for transmission of all data signals. PoH will also be supplied to a connected compatible PD receiver.
- ⑮ **SERVICE Port:** This port is reserved for firmware update use only.
- ⑯ **LAN Port:** Connect directly, or through a network switch, to your PC/laptop to control the unit via Telnet/WebGUI and to extend the network across the HDBaseT connection.
- ⑰ **DC24V 4-pin DIN Port:** Plug the 24V DC power adapter into this port and connect it to an AC wall outlet for power.

### 6.3 IR Cable Pinouts

IR Blaster Cable

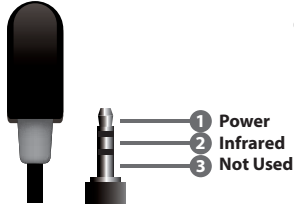

IR Extender Cable

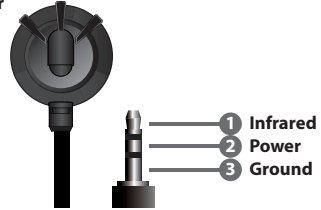

### 6.4 RS-232 Pinout and Defaults

Serial Port Default Settings	
Baud Rate	19200
Data Bits	8
Parity Bits	None
Stop Bits	1
Flow Control	None

RS-232 Port 1 (Unit control)

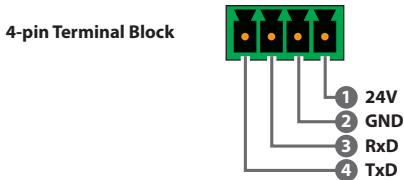

RS-232 Port 2 (HDBaseT extension)

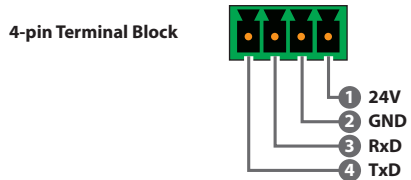

*Note: The 24 volt pins (pin 1) are included to provide power to a dedicated external control product and should NOT be used when connecting a standard RS-232 device.*

## 6.5 OSD Menu

All functions of this unit can be controlled by using the OSD (On Screen Display) which is activated by pressing the MENU button on the front of the unit. Use the + (PLUS), – (MINUS), and ENTER buttons to navigate the OSD menu. Press the MENU button to back out from any menu item and then press it again to close the menu.

MAIN MENU
<b>Video</b>
<b>Picture</b>
<b>Audio</b>
<b>OSD</b>
<b>Ethernet</b>
<b>EDID</b>
<b>System</b>
<b>Factory</b>
<b>Information</b>

The individual functions of the OSD will be introduced in the following section. Items marked in **BOLD** are the factory default settings.

VIDEO		
2 <sup>ND</sup> LEVEL	3 <sup>RD</sup> LEVEL	4 <sup>TH</sup> LEVEL
<b>HDMI Out Bypass</b>	<b>OFF</b>	
	On	
<b>Output Route</b>	USB-C	
	HDBT 1	
	HDBT 2	
	<b>HDMI 1</b>	
	HDMI 2	
	HDMI 3	
	HDMI 4	
	VGA 1	
VGA 2		
<b>Output Resolution</b>	<b>NATIVE HDMI</b>	
	Native HDBT	
	640x480@60	
	800x600@60	
	1024x768@60	
	1280x768@60	
	1360x768@60	
	1280x720@60	
	1280x800@60	
	1280x1024@60	
	1440x900@60	
	1400x1050@60	
	1680x1050@60	

VIDEO		
2 <sup>ND</sup> LEVEL	3 <sup>RD</sup> LEVEL	4 <sup>TH</sup> LEVEL
<b>Output Resolution (Cont.)</b>	1600x1200@60	
	1920x1080@60	
	1920x1200@60RB	
	2560x1600@60RB	
	720x480p	
	720x576p	
	1280x720p50	
	1280x720p60	
	1920x1080p24	
	1920x1080p25	
	1920x1080p30	
	1920x1080p50	
	1920x1080p60	
	3840x2160p24	
	3840x2160p25	
	3840x2160p30	
	3840x2160p50	
	3840x2160p60	
	3840x2160p50(420)	
	3840x2160p60(420)	
	4096x2160p24	
	4096x2160p25	
	4096x2160p30	
4096x2160p50		



VIDEO		
2 <sup>ND</sup> LEVEL	3 <sup>RD</sup> LEVEL	4 <sup>TH</sup> LEVEL
<b>Output Resolution (Cont.)</b>	4096x2160p60	
	4096x2160p50(420)	
	4096x2160p60(420)	
<b>Aspect</b>	Over Scan	
	Full	
	<b>BEST FIT</b>	
	Pan Scan	
	Letterbox	
	Under 1	
	Under 2	
	Follow In	
<b>Blank</b>	<b>OFF</b>	
	On	
<b>Freeze</b>	<b>OFF</b>	
	On	
<b>Auto Setting</b>	Auto Sync Off	<b>OFF</b>
		30s
		60s
	Auto Input	<b>OFF</b>
		Auto Switch
<b>HDCP Setting</b>	HDCP On USB-C	<b>ENABLED</b>
		Disabled
	HDCP On HDBT 1	<b>ENABLED</b>
		Disabled

VIDEO		
2 <sup>ND</sup> LEVEL	3 <sup>RD</sup> LEVEL	4 <sup>TH</sup> LEVEL
<b>HDCP Setting (Cont.)</b>	HDCP On HDBT 2	<b>ENABLED</b>
		Disabled
	HDCP On HDMI 1	<b>ENABLED</b>
		Disabled
	HDCP On HDMI 2	<b>ENABLED</b>
		Disabled
	HDCP On HDMI 3	<b>ENABLED</b>
		Disabled
	HDCP On HDMI 4	<b>ENABLED</b>
		Disabled

- HDMI Out Bypass:** Enable or disable the video output bypass mode. When bypass is enabled, HDR video and bitstream audio can be supported, however, it will disable the unit’s scaling and video adjustment functions.

*Note: This setting affects both the HDMI and HDBaseT outputs. This setting does not enable audio bypass.*

- Output Route:** Select the video input to route to both outputs.
- Output Resolution:** Select the output resolution to use when HDMI bypass is disabled. Selecting a “Native” resolution option will make the unit automatically select an output resolution based on the detected EDID of the connected display.

*Note: Not active when HDMI bypass mode is enabled.*

- Aspect:** Select the aspect ratio to use when outputting the source. “Full” stretches the source to fill the output resolution, regardless of the original aspect ratio, while “Best Fit” will always attempt to retain the original source’s correct aspect ratio by adding black bars if necessary. “Follow In” centres the source on the screen, without any scaling (1:1 pixel reproduction).

*Note: Not active when HDMI bypass mode is enabled.*

5) **Blank:** Enable or disable blanking the video output.

*Note: Not available when HDMI bypass mode is enabled.*

6) **Freeze:** Enable or disable freezing the video output.

*Note: Not available when HDMI bypass mode is enabled.*

7) **Auto Setting:**

- **Auto Sync Off:** Sets the amount of time to continue outputting sync with the free run colour if there is no live source and no operations have been executed on the unit. Setting this to "OFF" forces the unit to always output sync.

- **Auto Input:** Enable or disable automatic switching to any newly detected source.

8) **HDCP Setting:** Provides control over the HDCP behaviour of each input.

*Note: The VGA inputs are not listed as they cannot support HDCP.*

PICTURE		
2 <sup>ND</sup> LEVEL	3 <sup>RD</sup> LEVEL	4 <sup>TH</sup> LEVEL
Color Gain R	0~1023 <b>(512)</b>	
Color Gain G	0~1023 <b>(512)</b>	
Color Gain B	0~1023 <b>(512)</b>	
Color Offset R	0~1023 <b>(512)</b>	
Color Offset G	0~1023 <b>(512)</b>	
Color Offset B	0~1023 <b>(512)</b>	
Brightness	0~60 <b>(30)</b>	
Contrast	0~60 <b>(30)</b>	
Fine Tune HDMI (Digital sources only)	Hue	0~60 <b>(30)</b>
	Saturation	0~60 <b>(30)</b>
	Sharpness	0~63 <b>(0)</b>
	NR	<b>OFF</b>
		Low
		Middle
		High
		Auto
Fine Tune PC (Analogue sources only)	PC Auto	EXECUTE
	PC H Position	0~250
	PC V Position	0~250
	PC Clock	0~250
	PC Phase	0~255
	PC Reset	<b>NO</b>
		Execute

- 1) **Color Gain R/G/B:** Set the red, green, and blue color gain level of the scaled output.
- 2) **Color Offset R/G/B:** Set the red, green, and blue color offset level of the scaled output.
- 3) **Brightness/Contrast:** Set the overall brightness and contrast of the scaled output image.
- 4) **Fine Tune HDMI (Digital sources only):**
  - **Hue:** Set the hue shift of the scaled output image.
  - **Saturation:** Set the colour saturation level of the scaled output image.
  - **Sharpness:** Set the amount of sharpness processing to apply to the scaled output image.
  - **NR:** Set the aggressiveness of the digital noise reduction processing when applied to the scaled output image. Selecting "Off" disables all noise reduction processing.
- 5) **Fine Tune PC (VGA sources only):**
  - **PC Auto:** Provides a way to manually activate the auto-detection of the VGA source's settings. Select "Execute" to run the auto set.
  - **PC H/V Position:** Set the horizontal and vertical position for the current VGA input.
  - **PC Clock:** Set the PC clock setting for the current VGA input.
  - **PC Phase:** Set the PC phase setting for the current VGA input.
  - **PC Reset:** Reset all PC picture settings back to their factory defaults. Select "Execute" to activate the reset.

AUDIO		
2 <sup>ND</sup> LEVEL	3 <sup>RD</sup> LEVEL	4 <sup>TH</sup> LEVEL
<b>HDMI Out Bypass</b>	OFF	
	On	
<b>Audio Routing</b>	Follow User	
	FOLLOW VIDEO	
	Fixed Analog 1	
	Fixed Analog 2	
	Fixed Analog 3	
	Fixed Analog 4	
	Fixed Analog 5	
	Fixed Analog 6	
<b>Follow User Setting</b>	Audio On USB-C	<b>EMBEDDED</b>
		Analog 1
<b>Follow User Setting</b>	Audio On USB-C	Analog 2
		Analog 3
		Analog 4
		Analog 5
		Analog 6
	Audio On HDBT 1	[Same options as for USB-C]
	Audio On HDBT 2	[Same options as for USB-C]
	Audio On HDMI 1	[Same options as for USB-C]
Audio On HDMI 2	[Same options as for USB-C]	

AUDIO		
2 <sup>ND</sup> LEVEL	3 <sup>RD</sup> LEVEL	4 <sup>TH</sup> LEVEL
<b>Follow User Setting (Cont.)</b>	Audio On HDMI 3	[Same options as for USB-C]
	Audio On HDMI 4	[Same options as for USB-C]
	Audio On VGA 1	<b>ANALOG 1</b>
		Analog 2
		Analog 3
		Analog 4
		Analog 5
		Analog 6
	Audio On VGA 2	Analog 1
		<b>ANALOG 2</b>
Analog 3		
Analog 4		
Analog 5		
<b>Output Mixer</b>	<b>MIXER OFF</b>	
	Mixer On	
	Mic Only	
<b>Mic Gain</b>	0~100 (0)	
<b>HDMI Out Volume</b>	0~100 (85)	
<b>Analog Out Volume</b>	0~100 (85)	
<b>Speaker Out Volume</b>	0~100 (85)	
<b>HDMI Out Mute</b>	<b>OFF</b>	
	On	

AUDIO		
2 <sup>ND</sup> LEVEL	3 <sup>RD</sup> LEVEL	4 <sup>TH</sup> LEVEL
<b>Analog Out Mute</b>	<b>OFF</b>	
	On	
<b>Speaker Out Mute</b>	<b>OFF</b>	
	On	

- 1) **HDMI Out Bypass:** Enable or disable HDMI audio bypass mode. When enabled, all audio will automatically behave as if in “Follow Video” mode and bitstream audio can be supported.

*Note: This bypass setting affects audio only.*

- 2) **Audio Routing:** Select the audio routing behaviour of the unit.
  - **Follow User:** Audio routing will follow the selections made in the “Follow User Setting” section.
  - **Follow Video:** All digital sources will use their native embedded audio content. VGA 1 will use the Analogue 1 audio input and VGA 2 will use the Analogue 2 audio input.
  - **Fixed Analog 1~6:** Forces all video sources to be paired with the selected analogue audio source.

*Note: When HDMI Out Bypass for audio is enabled, all audio will automatically behave as if in “Follow Video” mode.*

- 3) **Follow User Setting:** Options for defining the audio routing to use when the “Follow User” mode is enabled. Select the preferred Follow User source for each input.

- 4) **Output Mixer:** Set the microphone mixing mode of the unit.
  - **Mixer Off:** Disable the audio mixer.
  - **Mixer On:** Enable the audio mixer. Audio from the current source and the microphone will be mixed together.
  - **MIC Only:** Output only the microphone audio source. This mode will override all other audio selections.

*Note: Activating Mixer On mode, or MIC Only mode will automatically disable HDMI Out Bypass mode.*



- 5) **Mic Gain:** Sets the microphone input's volume level when the microphone is an active audio source (mixed or unmixed).
- 6) **HDMI/Analog/Speaker Out Volume:** Set the volume level for each audio output type.

*Note: LPCM 2.0 sources only. Not active when HDMI audio Out Bypass is enabled.*

- 7) **HDMI/Analog/Speaker Out Mute:** Enable or disable muting the audio of each output type.

OSD	
2 <sup>ND</sup> LEVEL	3 <sup>RD</sup> LEVEL
<b>H Position</b>	0~100 <b>(50)</b>
<b>V Position</b>	0~100 <b>(50)</b>
<b>Transparency</b>	1~8 <b>(1)</b>
<b>OSD Menu Timeout</b>	<b>OFF</b>
	5s
	10s
	15s
	20s
	25s
	30s
	35s
	40s
	45s
	50s
	55s
60s	
<b>Display</b>	<b>INFO</b>
	Off
	On

- 1) **H/V Position:** Controls the position of the OSD menu.
- 2) **Transparency:** Set the transparency level of the OSD menu's background. The available range is from Level 0 (fully opaque) to Level 8 (fully transparent).
- 3) **OSD Menu Timeout:** Set how long to wait before automatically closing the OSD menu if there is no user activity. The timeout can be set to up to 60 seconds or disabled completely.

- 4) **Display:** Set the behaviour of the OSD informational display. Selecting "Info" will show the information display for a short time after a source or display change. Selecting "Off" will disable the info display. Selecting "On" will always show the info display.

ETHERNET		
2 <sup>ND</sup> LEVEL	3 <sup>RD</sup> LEVEL	4 <sup>TH</sup> LEVEL
<b>IP Mode</b>	<b>STATIC</b>	
	DHCP	
<b>Static IP Setting</b>	Static IP	0~255 <b>(192)</b>
		0~255 <b>(168)</b>
		0~255 <b>(1)</b>
		0~255 <b>(50)</b>
	Mask	0~255 <b>(255)</b>
		0~255 <b>(255)</b>
		0~255 <b>(0)</b>
		0~255 <b>(0)</b>
	Gate	0~255 <b>(192)</b>
		0~255 <b>(168)</b>
		0~255 <b>(1)</b>
		0~255 <b>(254)</b>
<b>IP</b>	[Current IP address]	
<b>MAC</b>	[Unit's MAC address]	

1) **IP Mode:** Set the unit to Static or DHCP mode. When DHCP mode is selected, all IP address information will be assigned automatically by the local DHCP server. When Static is selected, the IP address, netmask and gateway must be set manually and additional menu items become available.

2) **Static IP Setting:** The unit's static IP address, netmask, and gateway address can be set here. Press the "Enter" button to begin editing the address and use the "+" and "-" buttons to adjust each value. Press the "Enter" button to store the current number segment and move to the next segment.

*Note: The unit's default static IP address is 192.168.1.50.*

3) **IP/MAC:** Displays the unit's MAC address and current IP address.

EDID	
2 <sup>ND</sup> LEVEL	3 <sup>RD</sup> LEVEL
<b>EDID On USB-C</b>	<b>DEFAULT FHD 2CH</b>
	Default FHD MCh
	Default UHD 2Ch
	Default UHD MCh
	Default UHD+ 2Ch
	Default UHD+ MCh
	Default VGA
	User 1
	User 2
	Sink HDMI
Sink HDBT	
<b>EDID On HDBT 1</b>	[Same options as for USB-C]
<b>EDID On HDBT 2</b>	[Same options as for USB-C]
<b>EDID On HDMI 1</b>	[Same options as for USB-C]
<b>EDID On HDMI 2</b>	[Same options as for USB-C]
<b>EDID On HDMI 3</b>	[Same options as for USB-C]
<b>EDID On HDMI 4</b>	[Same options as for USB-C]
<b>EDID On VGA 1</b>	Default FHD 2Ch
	Default FHD MCh
	Default UHD 2Ch
	Default UHD MCh
	Default UHD+ 2Ch
	Default UHD+ MCh
	<b>DEFAULT VGA</b>

EDID	
2 <sup>ND</sup> LEVEL	3 <sup>RD</sup> LEVEL
<b>EDID On VGA 1 (Cont.)</b>	User 1
	User 2
	Sink HDMI
	Sink HDBT
<b>EDID On VGA 2</b>	[Same options as for VGA 1]

**1) EDID Selection:** Select the EDID to use with each input.

*Note: In most cases, assigning a new EDID to an input will cause the affected input to briefly blink out while the source adapts to the new information.*

SYSTEM	
2 <sup>ND</sup> LEVEL	3 <sup>RD</sup> LEVEL
<b>Relay 1</b>	<b>OFF</b>
	On
<b>Relay 2</b>	<b>OFF</b>
	On
<b>RS-232</b>	<b>HDBT OUT</b>
	HDBT In 1
	HDBT In 2
<b>IR</b>	<b>HDBT OUT</b>
	HDBT In 1
	HDBT In 2

- 1) **Relay 1~2:** Manually open or close Relay 1 and Relay 2. Selecting “ON” closes the relay, selecting “OFF” opens it.
- 2) **RS-232:** Set which HDBaseT port the local RS-232 port should route across. Available choices are HDBT Out, HDBT In1, and HDBT In2.
- 3) **IR:** Set which HDBaseT port the local IR ports should route across. Available choices are HDBT Out, HDBT In1, and HDBT In2.

FACTORY	
2 <sup>ND</sup> LEVEL	3 <sup>RD</sup> LEVEL
<b>Reset All</b>	<b>NO</b>
	Execute
<b>FW Update From USB</b>	<b>NO</b>
	Execute

- 1) **Reset All:** Selecting “Execute” will reset all of the unit’s settings back to their factory defaults.
- 2) **FW Update From USB:** Provides a way to update the unit’s firmware. Insert a USB thumb drive, with a valid firmware file (\*.bin format) in the root directory, into the unit’s USB service port then select this option. After the update is complete the unit will automatically reboot.

INFORMATION	
2 <sup>ND</sup> LEVEL	3 <sup>RD</sup> LEVEL
<b>Video HDMI Out Bypass</b>	[Current System Settings]
<b>Output Route</b>	
<b>Output Resolution</b>	
<b>Audio HDMI Out Bypass</b>	
<b>Output Route</b>	
<b>Output Mixer</b>	
<b>IP</b>	
<b>Version</b>	[Current Firmware Version]

- 1) **Information:** This screen displays information about the unit’s current state, input and output status, as well as the current firmware version.



## 6.6 WebGUI Control

### Device Discovery

Please obtain the “Device Discovery” software from your authorised dealer and save it in a directory where you can easily find it.

Connect the unit and your PC/Laptop to the same active network and execute the “Device Discovery” software. Click on “Find Devices on Network” and a list of devices connected to the local network will show up indicating their current IP address.

*Note: The unit’s default IP address is 192.168.1.50.*

Find Devices on Network			
Product Name	Description	IP Address	MAC Address

By clicking on one of the listed devices you will be presented with the network details of that particular device.

Product ID	
Product Name	
MAC Address	00:00:00:00:00:00
IP Address	<input type="text"/>
Subnet Mask	<input type="text"/>
Gateway IP	<input type="text"/>
DNS	<input type="text"/>
IP Mode	Static
Web GUI Port	Static
Telnet Port	0
S / N	
Firmware Version	
Hardware Version	
Description	
Web GUI	<a href="#">Web GUI</a>
<input type="button" value="Save"/> <input type="button" value="Reboot"/>	

- 1) IP Mode:** If you choose, you can alter the static IP network settings for the device, or switch the unit into DHCP mode to automatically obtain proper network settings from a local DHCP server. To switch to DHCP mode, please select DHCP from the IP mode drop-down, then click “Save” followed by “Reboot”.
- 2) WebGUI Hotkey:** Once you are satisfied with the network settings, you may use them to connect via Telnet or WebGUI. The network information window provides a convenient link to launch the WebGUI directly.

## WebGUI Overview

After connecting to the WebGUI's address in a web browser, the login screen will appear. Please enter the appropriate user name and password then click "Submit" to log in.

*Note: The default user name and password is "admin".*

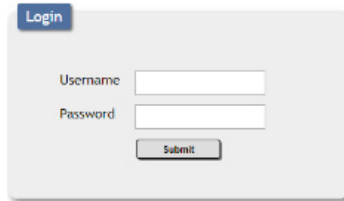

On the left side of the browser, you will see the following menu tabs where all primary functions of the unit are controllable via the built-in WebGUI. The individual functions will be introduced in the following sections.



Clicking the red "Logout" tab will automatically log the currently connected user out of the WebGUI and return to login page.

## 6.6.1 Video Tab

This page provides video routing settings, I/O renaming options and control over the video output signal's format and behaviour.

To begin assigning a new video route, please click an output button and then click on the button of the preferred input port. As you select each button they will change their colour to orange. The new route will become active immediately after selecting the input port and the routing information displayed on the buttons will change accordingly.

*Note: Both outputs are linked together, so selecting a source for one will automatically change the source for the other.*

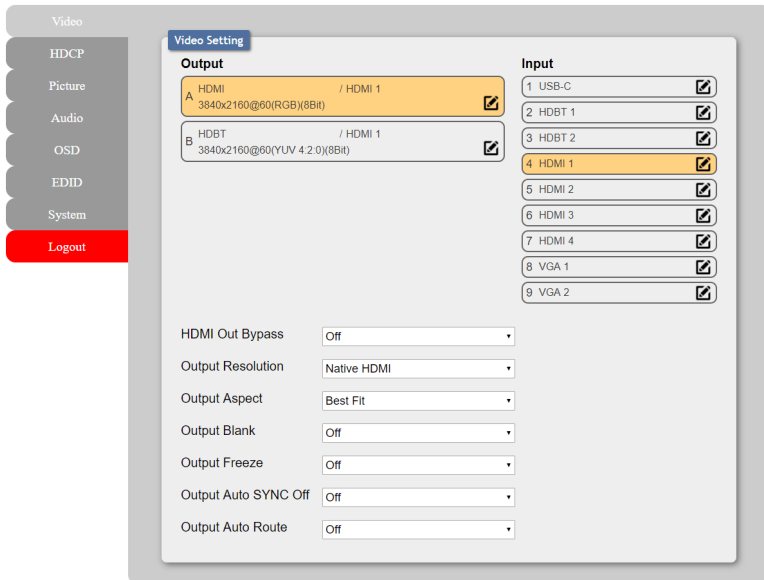

- 1) **Output:** Buttons for selecting the output (A & B) to route A/V Inputs to. Details about the output names and currently selected Input are also displayed here. To change the name of an output, click on the edit icon (✎).
- 2) **Input:** Buttons for selecting the input to route to the selected output. Detail about the input names is also displayed here. To change the name of an output, click on the edit icon (✎).

### 3) Additional Settings:

- **HDMI Out Bypass:** Enable or disable the video output bypass mode. When bypass is enabled, HDR video and bitstream audio can be supported, however, it will disable the unit's scaling and video adjustment functions.

*Note: This setting affects both the HDMI and HDBaseT outputs. This setting does not enable audio bypass.*

- **Output Resolution:** Selects the output resolution to use when HDMI bypass is disabled. Selecting a "Native" resolution option will make the unit automatically select an output resolution based on the detected EDID of the connected display.

*Note: Not active when HDMI bypass mode is enabled.*

- **Output Aspect:** Selects the aspect ratio to use when outputting the source. "Full" stretches the source to fill the output resolution, regardless of the original aspect ratio, while "Best Fit" will always attempt to retain the original source's correct aspect ratio by adding black bars if necessary. "Follow In" centres the source on the screen, without any scaling (1:1 pixel reproduction).

*Note: Not active when HDMI bypass mode is enabled.*

- **Output Blank:** Enable or disable blanking the video output.

*Note: Not available when HDMI bypass mode is enabled.*

- **Output Freeze:** Enable or disable freezing the video output.

*Note: Not available when HDMI bypass mode is enabled.*

- **Output Auto Sync Off:** Sets the amount of time to continue outputting sync with the free run colour if there is no live source and no operations have been executed on the unit. Setting this to "OFF" forces the unit to always output sync.

- **Output Auto Route:** Enable or disable automatic switching to any newly detected source.

## 6.6.2 HDCP Tab

Provides control over the HDCP behaviour of each input. To enable or disable HDCP support on one or more inputs, select the preferred inputs on the left, and then select the HDCP mode on the right. The change will occur immediately. *Note: The VGA inputs are not listed as they cannot support HDCP.*

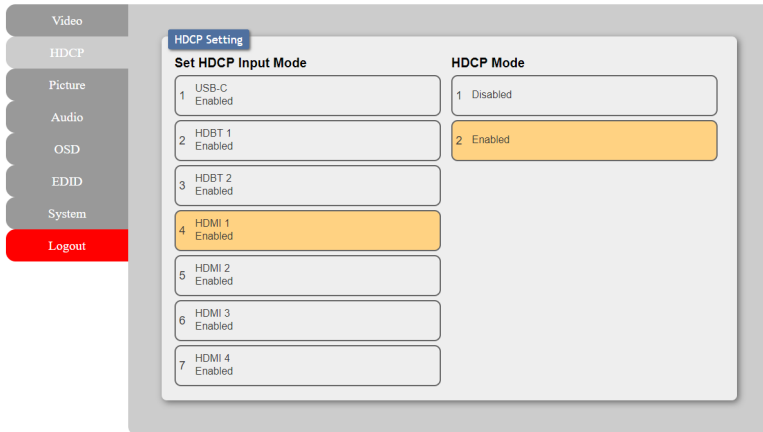

Set HDCP Input Mode		HDCP Mode	
1	USB-C Enabled	1	Disabled
2	HDBT 1 Enabled	2	Enabled
3	HDBT 2 Enabled		
4	HDMI 1 Enabled		
5	HDMI 2 Enabled		
6	HDMI 3 Enabled		
7	HDMI 4 Enabled		

### 6.6.3 Picture Tab

This tab provides controls over the scaled video output's colour, brightness, contrast. When a digital source is selected hue, saturation and noise reduction are also controllable. When a VGA input is selected, the available controls will change and auto set, H/V position, clock and phase will become adjustable instead.

*Note: These features are not active when HDMI bypass mode is enabled.*

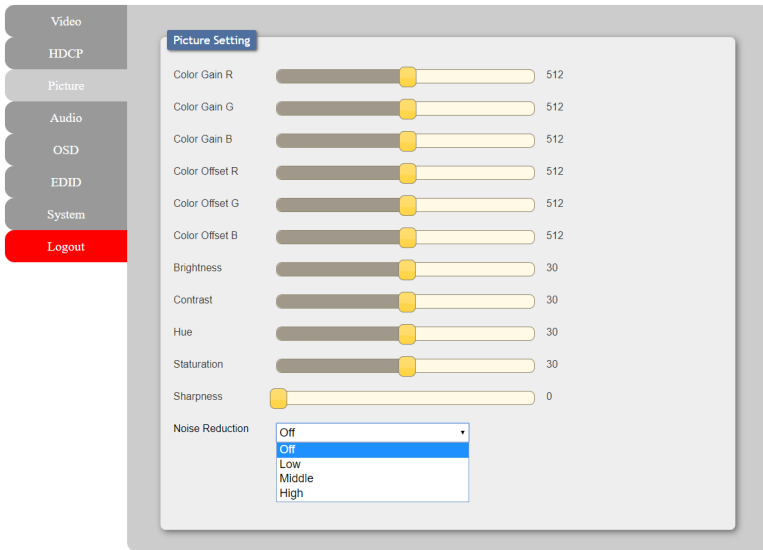

#### 1) Picture Settings (Global):

- **Color Gain R/G/B:** These sliders provide control over the red, green, and blue color gain level of the scaled output.
- **Color Offset R/G/B:** These sliders provide control over the red, green, and blue color offset level of the scaled output.
- **Brightness:** Provides control over the overall brightness of the scaled output image.
- **Contrast:** Provides control over the overall contrast of the scaled output image.

## 2) Picture Settings (Digital Sources):

- **Hue:** Provides control over the hue shift of the scaled output image.
- **Saturation:** Provides control over the colour saturation level of the scaled output image.
- **Sharpness:** Provides control over the amount of sharpness processing to apply to the scaled output image.
- **Noise Reduction:** Provides control over the aggressiveness of the digital noise reduction processing when applied to the scaled output image. Selecting "Off" disables all noise reduction processing.

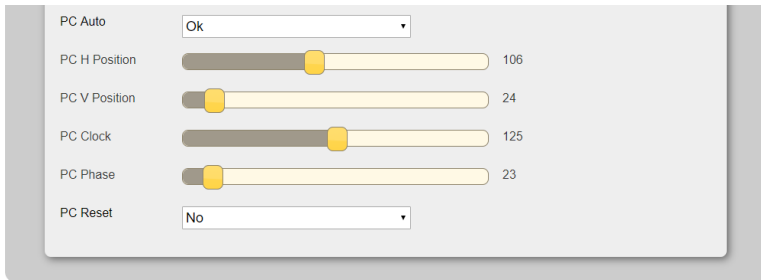

## 3) Picture Settings (VGA Source):

- **PC Auto:** Provides a way to manually activate the auto-detection of the VGA source's settings.
- **PC H/V Position:** Set the horizontal and vertical position setting for the current VGA input.
- **PC Clock:** Set the PC clock setting for the current VGA input.
- **PC Phase:** Set the PC phase setting for the current VGA input.
- **PC Reset:** Reset all PC picture settings back to their factory defaults.

## 6.6.4 Audio Tab

This tab provides control over how audio is routed within the unit as well as control over audio mixing, individual output volume and the microphone's gain level.

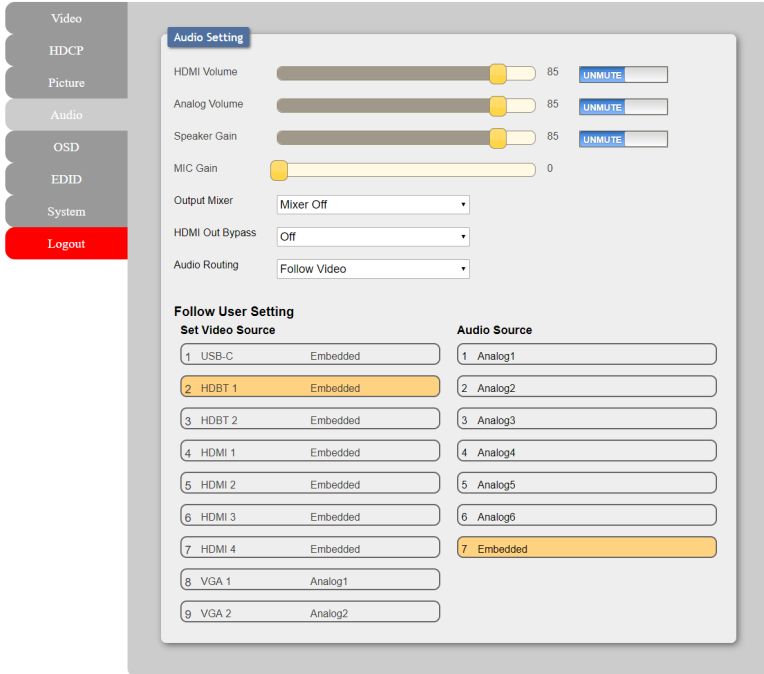

### 1) Audio Settings:

- HDMI Volume & Mute:** Set the volume level, or mute the audio, for the HDMI and HDBaseT audio outputs.  
*Note: Not active when HDMI audio Out Bypass is enabled.*
- Analog Volume & Mute:** Set the volume level, or mute the audio, for the unamplified (5-pin terminal block) analogue audio output.  
*Note: LPCM 2.0 sources only.*
- Speaker Gain & Mute:** Set the volume level, or mute the audio, for the amplified (2x 2-pin terminal blocks) analogue audio output.  
*Note: LPCM 2.0 sources only.*



- **MIC Gain:** Sets the microphone input's volume level when the microphone is an active audio source (mixed or unmixed).
- **Output Mixer:** Set the microphone mixing mode of the unit
  - **Mixer Off:** Disable the audio mixer.
  - **Mixer On:** Enable the audio mixer. Audio from the current source and the microphone will be mixed together.
  - **MIC Only:** Output only the microphone audio source. This mode will override all other audio selections.

*Note: Activating Mixer On mode, or MIC Only mode will automatically disable HDMI Out Bypass mode.*

- **HDMI Out Bypass (audio only):** Enable or disable HDMI audio bypass mode. When enabled, all audio will automatically behave as if in "Follow Video" mode and bitstream audio can be supported.

*Note: This bypass setting affects audio only.*

- **Audio Routing:** Use the dropdown to select the audio routing behaviour of the unit.
  - **Follow User:** Audio routing will follow the selections made in the "Follow User Setting" section.
  - **Follow Video:** All digital sources will use their native embedded audio content. VGA 1 will use the Analogue 1 audio input and VGA 2 will use the Analogue 2 audio input.
  - **Fixed Analogue 1~6:** Forces all video sources to be paired with the selected analogue audio source.

*Note: When HDMI audio Out Bypass is enabled, all audio will automatically behave as if in "Follow Video" mode.*

- 2) **Follow User Setting:** These routing settings are only enforced when Audio Routing has been set to "Follow User".

*Note: Not active when HDMI audio Out Bypass is enabled.*

- **Set Video and Audio Source:** Buttons for defining the audio routing to use when the "Follow User" mode is enabled. To begin assigning a new audio route, select one or more video sources on the left, then select the audio source to route with them on the right. As you select each button they will change their colour to orange. The new routing information will be displayed on the Video Source buttons after selection.

### 6.6.5 OSD Tab

This tab provides controls over the appearance of the unit’s informational OSD and OSD menu.

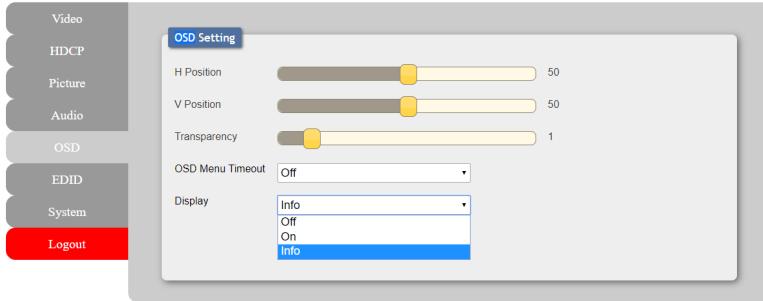

- 1) **H/V Position:** Controls the position of the OSD menu.
- 2) **Transparency:** Controls the transparency level of the OSD menu’s background. The available range is from Level 0 (fully opaque) to Level 8 (fully transparent).
- 3) **OSD Menu Timeout:** Controls how long to wait before automatically closing the OSD menu if there is no user activity. The timeout can be set to up to 60 seconds or disabled completely.
- 4) **Display:** Controls the behaviour of the OSD informational display. Selecting “Info” will show the information display for a short time after a source or display change. Selecting “Off” will disable the info display. Selecting “On” will always show the info display.

### 6.6.6 EDID Tab

This tab provides control over the EDID settings of all inputs. This unit provides the option of seven standard EDIDs, two sink sourced EDIDs and two user uploaded EDIDs that can be assigned to each input port individually. The names of the two user uploaded EDIDs can be changed if desired.

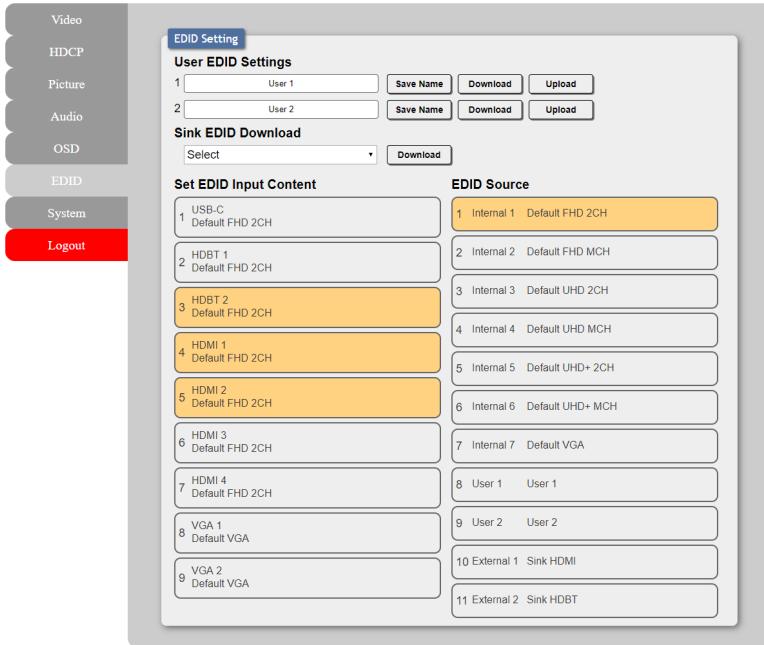

## 1) User EDID Settings:

- **Save Name:** To change the name of a User EDID, type the new name in the space provided, then click on the “Save Name” button.
- **Download:** To save an existing User EDID to your local PC please press the “Download” button next to the EDID you would like to save. Depending on your browser settings you will either be asked where to save the downloaded file, or the file will be transferred directly to the default download location on your PC.
- **Upload:** To upload a new User EDID, please click the “Upload” button next to the User EDID Settings item you would like to change. An EDID Upload window will appear, allowing you to locate and upload the preferred EDID file (\*.bin format) from a local PC. Once the correct file has been selected, please click the “Upload” button in the window, and the file will be transferred to the unit.

- 2) **Sink EDID Download:** To save the EDID from one of the connected displays to your local PC, select the appropriate sink from the dropdown list then press the “Download” button. Depending on your browser settings you will either be asked where to save the downloaded file, or the file will be transferred directly to the default download location on your PC.
- 3) **Set EDID Input Content:** This section provides controls for assigning EDID to the unit’s inputs. Click on the preferred input(s) on the left and then select the EDID on the right and the change will occur immediately. Multiple inputs can be selected at once if desired.

*Note: In most cases, assigning a new EDID to an input will cause the affected input to briefly blink out while the source adapts to the new information.*

This unit provides the following 7 default EDIDs:

Unit’s Default EDIDs	
<b>FHD 2CH</b>	1920×1080p@60Hz (4.95Gbps) & 8-bit colour, LPCM 2.0
<b>FHD MCH</b>	1920×1080p@60Hz (4.95Gbps) & 8-bit colour, LPCM 7.1 & Bitstream
<b>UHD 2CH</b>	3840×2160p@30Hz (10.2Gbps) & Deep Colour (8/10/12-bit), LPCM 2.0
<b>UHD MCH</b>	3840×2160p@30Hz (10.2Gbps) & Deep Colour (8/10/12-bit), LPCM 7.1 & Bitstream
<b>UHD+ 2CH</b>	3840×2160p@60Hz (18Gbps) & Deep Colour (8/10/12-bit), LPCM 2.0
<b>UHD+ MCH</b>	3840×2160p@60Hz (18Gbps) & Deep Colour (8/10/12-bit), LPCM 7.1 & Bitstream
<b>VGA</b>	1920×1080p@60Hz (148MHz) & 8-bit colour

*Note: In some rare cases it is possible for custom or external EDIDs to cause compatibility issues with certain sources. If this happens, it is recommended to switch to one of the 7 default EDIDs for maximum compatibility.*

## 6.6.7 System Tab

Click on the “System” tab to make changes to various system settings. From this tab, you can change the WebGUI login username and password as well as configure the RS-232/IR HDBaseT routing. Finally, this tab provides buttons to reset the unit to factory defaults and to update the firmware.

The screenshot shows the 'System Setting' web interface. On the left is a navigation menu with 'System' selected and 'Logout' highlighted in red. The main content area is titled 'System Setting' and contains the following sections:

- Web User Setting:** Fields for Username, Password, New Username, Confirm Username, New Password, and Confirm Password, with a 'Save' button.
- Network:** IP Mode (Static IP), IP, Netmask, Gateway, Static IP, Static Netmask, and Static Gateway, with a 'Save' button.
- Control Route Setting:** Relay 1, Relay 2, RS232, and IR, each with a dropdown menu.
- Reset to Default:** A 'Factory Default' button.
- Firmware Upgrade:** A 'Choose File' button (No file chosen) and an 'Upgrade' button.

- 1) **Web User Setting:** This section allows for the login password to be changed.

*Note: The default user name and password is “admin”.*

- 2) **Network:** IP mode may be switched between Static IP or DHCP. In Static IP mode the IP, netmask and gateway addresses may be manually set. When in DHCP mode, the unit will attempt to connect to a local DHCP server and obtain IP, netmask and gateway addresses automatically. Please press “Save” after making any changes to the IP configuration or mode.

*Note: If the IP address is changed then the IP address required for WebGUI/ Telnet access will also change accordingly.*

- 3) **Control Route Setting:** These settings control the unit's 2 relay ports as well as defining the HDBaseT routing to use for the RS-232 and IR ports on the unit.
  - **Relay 1 & 2:** Manually open or close Relay 1 and Relay 2. Selecting "ON" closes the relay, selecting "OFF" opens it.
  - **RS232:** Use the dropdown to select which HDBaseT port the local RS-232 port should route across. Available choices are HDBT Out, HDBT In1, and HDBT In2.
  - **IR:** Use the dropdown to select which HDBaseT port the local IR ports should route across. Available choices are HDBT Out, HDBT In1, and HDBT In2.
- 4) **Reset to Default:** Press the "ALL Reset" button to reset the unit to its factory default state. After the reset is complete, the unit will reboot automatically.
- 5) **Firmware Upgrade:** To update the unit's firmware, click the "Choose File" button to open the file selection window and then select the firmware update file (\*.bin format) located on your local PC. After selecting the file, click the "Upgrade" button to begin the firmware update process. After the upgrade is complete, the unit will reboot automatically.

## 6.7 Telnet Control

Before attempting to use Telnet control, please ensure that both the unit and the PC are connected to the same active networks.

To Access the Command Line Interface (CLI)	
<b>Windows 7</b>	Click <b>Start</b> , type “cmd” in the search field, and press <b>Enter</b> .
<b>Windows XP</b>	Click <b>Start</b> > <b>Run</b> , type “cmd”, and press <b>Enter</b> .
<b>Mac OS X</b>	Click <b>Go</b> > <b>Applications</b> > <b>Utilities</b> > <b>Terminal</b> .

Once in the Command Line Interface (CLI) type “telnet” followed by the IP address of the unit (and the port number if it is non-standard) and then hit “Enter”. This will connect us to the unit we wish to control.

```
Microsoft Windows [Version 6.1.7601]
Copyright (c) 2009 Microsoft Corporation. All rights reserved.

C:\Users\Administrator>telnet 192.168.1.50 23
```

*Note 1: If the IP address is changed then the IP address required for Telnet access will also change accordingly.*

*Note 2: The default IP address is 192.168.1.50.*

## 6.8 Serial and Telnet Commands

COMMAND
Description and Parameters
<p><b>HELP</b>↵</p> <p>Show the full command list.</p>
<p><b>?</b>↵</p> <p>Show the full command list.</p>
<p><b>HELP N1</b>↵</p> <p>Show details about the specified command.</p> <p><b>N1</b> = {Command name}</p>
<p><b>GET MODEL NAME</b>↵</p> <p>Show the unit's model name.</p>
<p><b>GET FW VER</b>↵</p> <p>Show the unit's current firmware version.</p>
<p><b>GET MODEL TYPE</b>↵</p> <p>Show the unit's product type.</p>
<p><b>SET FACTORY DEFAULT</b>↵</p> <p>Reset the unit to the factory defaults.</p>
<p><b>GET ALL COMMAND INDEX LIST</b>↵</p> <p>Show the unit's full console command index list.</p>
<p><b>SET SYSTEM REBOOT</b>↵</p> <p>Reboot the unit.</p>



COMMAND	
Description and Parameters	
<b>SET IP MODE N1</b> ←	
Set the IP address assignment mode.	
Available values for <b>N1</b> :	
0	[Static IP Mode]
1	[DHCP Mode]
<b>GET IP MODE</b> ←	
Show the current IP address assignment mode.	
<b>GET IPADDR</b> ←	
Show the unit's current IP address.	
<b>GET MAC ADDR</b> ←	
Show the unit's MAC address.	
<b>SET STATIC IPADDR N1</b> ←	
Set the unit's static IP address.	
<b>N1</b> = X.X.X.X	[X = 0 ~ 255, IP address]
<b>GET STATIC IPADDR</b> ←	
Show the unit's current static IP address.	
<b>SET STATIC NETMASK N1</b> ←	
Set the unit's static netmask.	
<b>N1</b> = X.X.X.X	[X = 0 ~ 255, netmask]
<b>GET STATIC NETMASK</b> ←	
Show the unit's current netmask.	
<b>SET STATIC GATEWAY N1</b> ←	
Set the unit's static gateway address.	
<b>N1</b> = X.X.X.X	[X = 0 ~ 255, gateway address]

COMMAND
Description and Parameters
<p><b>GET STATIC GATEWAY</b> ←</p> <p>Show the unit's current gateway address.</p>
<p><b>SET WEBGUI USERNAME N1</b> ←</p> <p>Set the WebGUI login username.</p> <p><b>N1</b> = {Name} [16 characters max]</p>
<p><b>GET WEBGUI USERNAME</b> ←</p> <p>Show the current WebGUI login username.</p>
<p><b>SET WEBGUI PASSWORD N1</b> ←</p> <p>Set the WebGUI login password.</p> <p><b>N1</b> = {Name} [16 characters max]</p>
<p><b>GET WEBGUI PASSWORD</b> ←</p> <p>Show the current WebGUI login password.</p>
<p><b>GET IN PORT NUMBER</b> ←</p> <p>Show the total number of inputs on the unit.</p>
<p><b>GET OUT PORT NUMBER</b> ←</p> <p>Show the total number of outputs on the unit.</p>

## COMMAND

### Description and Parameters

#### SET OUT A ROUTE N1 ↵

Route the specified input to both outputs.

Available values for **N1**:

1	[USB-C input]
2	[HDBaseT input 1]
3	[HDBaseT input 2]
4	[HDMI input 1]
5	[HDMI input 2]
6	[HDMI input 3]
7	[HDMI input 4]
8	[VGA input 1]
9	[VGA input 2]

#### GET OUT A ROUTE ↵

Show the current input routed to both outputs.

#### SET OUT AUTO MODE N1 ↵

Set the auto-switching behaviour of the unit.

Available values for **N1**:

0	[Off]
1	[Auto switch]

#### GET OUT AUTO MODE ↵

Show the current auto-switching mode of the unit.

**COMMAND**

**Description and Parameters**

**GET IN N1 TIMING ↵**

Show the index number of the current resolution detected on the specified input.

Available values for **N1**:

- |   |                   |
|---|-------------------|
| 1 | [USB-C input]     |
| 2 | [HDBaseT input 1] |
| 3 | [HDBaseT input 2] |
| 4 | [HDMI input 1]    |
| 5 | [HDMI input 2]    |
| 6 | [HDMI input 3]    |
| 7 | [HDMI input 4]    |
| 8 | [VGA input 1]     |
| 9 | [VGA input 2]     |

**GET IN N1 TIMING STRING ↵**

Show the index number and description of the current resolution detected on the specified input.

Available values for **N1**:

- |   |                   |
|---|-------------------|
| 1 | [USB-C input]     |
| 2 | [HDBaseT input 1] |
| 3 | [HDBaseT input 2] |
| 4 | [HDMI input 1]    |
| 5 | [HDMI input 2]    |
| 6 | [HDMI input 3]    |
| 7 | [HDMI input 4]    |
| 8 | [VGA input 1]     |
| 9 | [VGA input 2]     |

## COMMAND

### Description and Parameters

#### SET OUT A TIMING N1 ←

Set the output resolution to use for both outputs.

Available values for **N1**:

0	[Native HDMI]	21	[1920x1080p24]
1	[Native HDBaseT]	22	[1920x1080p25]
2	[640x480@60]	23	[1920x1080p30]
3	[800x600@60]	24	[1920x1080p50]
4	[1024x768@60]	25	[1920x1080p60]
5	[1280x768@60]	26	[3840x2160p24]
6	[1360x768@60]	27	[3840x2160p25]
7	[1280x720@60]	28	[3840x2160p30]
8	[1280x800@60]	29	[3840x2160p50]
9	[1280x1024@60]	30	[3840x2160p60]
10	[1440x900@60]	31	[3840x2160p50(4:2:0)]
11	[1400x1050@60]	32	[3840x2160p60(4:2:0)]
12	[1680x1050@60]	33	[4096x2160p24]
13	[1600x1200@60]	34	[4096x2160p25]
14	[1920x1080@60]	35	[4096x2160p30]
15	[1920x1200@60RB]	36	[4096x2160p50]
16	[2560x1600@60RB]	37	[4096x2160p60]
17	[720x480p]	38	[4096x2160p50(4:2:0)]
18	[720x576p]	39	[4096x2160p60(4:2:0)]
19	[1280x720p50]		
20	[1280x720p60]		

#### GET OUT A TIMING ←

Show the index number of the current resolution used by both outputs.

COMMAND
Description and Parameters
<p><b>GET OUT A TIMING STRING</b> ←</p> <p>Show the description string of the current resolution used by both outputs.</p>
<p><b>GET IN SOURCE LIST</b> ←</p> <p>List the port type of all inputs on the unit.</p>
<p><b>GET OUT TIMING LIST</b> ←</p> <p>List all available output resolutions with their local index numbers.</p>
<p><b>SET OUT A CONTRAST N1</b> ←</p> <p>Set the scaled output's contrast level.</p> <p><b>N1</b> = 0~60 [Contrast level]</p>
<p><b>GET OUT A CONTRAST</b> ←</p> <p>Show the contrast level when the output is scaled.</p>
<p><b>SET OUT A BRIGHTNESS N1</b> ←</p> <p>Set the scaled output's brightness level.</p> <p><b>N1</b> = 0~60 [Brightness level]</p>
<p><b>GET OUT A BRIGHTNESS</b> ←</p> <p>Show the brightness level when the output is scaled.</p>
<p><b>SET OUT A SATURATION N1</b> ←</p> <p>Set the scaled output's saturation level.</p> <p><b>N1</b> = 0~60 [Saturation level]</p>
<p><b>GET OUT A SATURATION</b> ←</p> <p>Show the saturation level when the output is scaled.</p>

COMMAND	
Description and Parameters	
<b>SET OUT A HUE N1</b> ←	
Set the scaled output's hue value.	
<b>N1</b> = 0~60	[Hue value]
<b>GET OUT A HUE</b> ←	
Show the hue value when the output is scaled.	
<b>SET OUT A SHARPNESS N1</b> ←	
Set the scaled output's sharpness level.	
<b>N1</b> = 0~63	[Sharpness level]
<b>GET OUT A SHARPNESS</b> ←	
Show the sharpness level when the output is scaled.	
<b>SET OUT A NR N1</b> ←	
Set the amount of noise reduction to apply when the output is scaled.	
Available values for <b>N1</b> :	
0	[Off]
1	[Low]
2	[Middle]
3	[High]
<b>GET OUT A SHARPNESS</b> ←	
Show the sharpness level when the output is scaled.	
<b>SET OUT A NR N1</b> ←	
Set the amount of noise reduction to apply when the output is scaled.	
Available values for <b>N1</b> :	
0	[Off]
1	[Low]
2	[Middle]
3	[High]

COMMAND	
Description and Parameters	
<b>GET OUT A NR</b> ←	
Show the current amount of noise reduction applied when the output is scaled.	
<b>SET OUT A ASPECT RATIO N1</b> ←	
Set the aspect ratio of the video shown when the output is scaled.	
Available values for <b>N1</b> :	
1	[Overscan]
2	[Full]
3	[Best fit]
4	[Pan & scan]
5	[Letterbox]
6	[Underscan 1]
7	[Underscan 2]
8	[Follow input]
<b>GET OUT A ASPECT RATIO</b> ←	
Show the currently set aspect ratio for the video shown when the output is scaled.	
<b>GET OUT ASPECT RATIO LIST</b> ←	
List all available aspect ratio options.	
<b>SET OUT A AUTO SYNC OFF N1</b> ←	
Enable or disable the Auto Sync Off function and set the timeout length.	
Available values for <b>N1</b> :	
0	[Disabled]
1	[30 seconds]
2	[60 seconds]



COMMAND
<b>Description and Parameters</b>
<b>GET OUT A AUTO SYNC OFF</b> ← Show the current setting for Auto Sync Off
<b>SET OUT A R GAIN N1</b> ← Set the scaled output's red gain level. <b>N1</b> = 0~1023 [Red gain level]
<b>GET OUT A R GAIN</b> ← Show the scaled output's current red gain level.
<b>SET OUT A G GAIN N1</b> ← Set the scaled output's green gain level. <b>N1</b> = 0~1023 [Green gain level]
<b>GET OUT A G GAIN</b> ← Show the scaled output's current green gain level.
<b>SET OUT A B GAIN N1</b> ← Set the scaled output's blue gain level. <b>N1</b> = 0~1023 [Blue gain level]
<b>GET OUT A B GAIN</b> ← Show the scaled output's current blue gain level.
<b>SET OUT A R OFFSET N1</b> ← Set the scaled output's red offset. <b>N1</b> = 0~1023 [Red offset]
<b>GET OUT A R OFFSET</b> ← Show the scaled output's current red offset.

COMMAND	
Description and Parameters	
<b>SET OUT A G OFFSET N1</b> ←	
Set the scaled output's green offset.	
<b>N1</b> = 0~1023	[Green offset]
<b>GET OUT A G OFFSET</b> ←	
Show the scaled output's current green offset.	
<b>SET OUT A B OFFSET N1</b> ←	
Set the scaled output's blue offset.	
<b>N1</b> = 0~1023	[Blue offset]
<b>GET OUT A B OFFSET</b> ←	
Show the scaled output's current blue offset.	
<b>SET IN N1 PHASE N2</b> ←	
Set the PC phase value for the specified input (VGA inputs only).	
Available values for <b>N1</b> :	
8	[VGA input 1]
9	[VGA input 2]
<b>N2</b> = 0~255	[PC phase]
<b>GET IN N1 PHASE</b> ←	
Show the current PC phase value for the specified input (VGA inputs only).	
Available values for <b>N1</b> :	
8	[VGA input 1]
9	[VGA input 2]

COMMAND	
Description and Parameters	
<b>SET IN N1 CLOCK N2</b> ↵	
Set the PC clock value for the specified input (VGA inputs only).	
Available values for <b>N1</b> :	
8	[VGA input 1]
9	[VGA input 2]
<b>N2</b> = 0~250	[PC clock]
<b>GET IN N1 CLOCK</b> ↵	
Show the current PC clock value for the specified input (VGA inputs only).	
Available values for <b>N1</b> :	
8	[VGA input 1]
9	[VGA input 2]
<b>SET IN N1 HPOSITION N2</b> ↵	
Set the PC horizontal position for the specified input (VGA inputs only).	
Available values for <b>N1</b> :	
8	[VGA input 1]
9	[VGA input 2]
<b>N2</b> = 0~250	[Horizontal position]
<b>GET IN N1 HPOSITION</b> ↵	
Show the current PC horizontal position for the specified input (VGA inputs only).	
Available values for <b>N1</b> :	
8	[VGA input 1]
9	[VGA input 2]

COMMAND	
Description and Parameters	
<b>SET IN N1 VPOSITION N2↵</b>	
Set the PC vertical position for the specified input (VGA inputs only).	
Available values for <b>N1</b> :	
8	[VGA input 1]
9	[VGA input 2]
<b>N2</b> = 0~250	[Vertical position]
<b>GET IN N1 VPOSITION↵</b>	
Show the current PC vertical position for the specified input (VGA inputs only).	
Available values for <b>N1</b> :	
8	[VGA input 1]
9	[VGA input 2]
<b>SET HDMI OUT VIDEO BYPASS N1↵</b>	
Enable or disable the video output bypass mode.	
Available values for <b>N1</b> :	
0	[Video bypass disabled]
1	[Video bypass enabled]
<b>GET HDMI OUT VIDEO BYPASS↵</b>	
Show the current video output bypass mode state.	
<b>SET VGA IN RESET↵</b>	
Reset the VGA input settings to the factory defaults.	

**COMMAND****Description and Parameters****SET VGA IN AUTO** ←

Activate the auto-detection of the current VGA source's parameters.

**SET OUT A BLANK N1** ←

Enable or disable blanking the video output

Available values for **N1**:

0	[Video output normal]
1	[Video output blanked]

**GET OUT A BLANK** ←

Show the current video output blanking state.

**SET OUT A FREEZE N1** ←

Enable or disable freezing the video output.

Available values for **N1**:

0	[Video output normal]
1	[Video output frozen]

**GET OUT A FREEZE** ←

Show the current video output freeze state.

COMMAND	
Description and Parameters	
<b>SET OUT A OSD TIMER N1</b> ←	
Set the OSD menu's timeout value.	
Available values for <b>N1</b> :	
0	[Timeout disabled]
1	[5 seconds]
2	[10 seconds]
3	[15 seconds]
4	[20 seconds]
5	[25 seconds]
6	[30 seconds]
7	[35 seconds]
8	[40 seconds]
9	[45 seconds]
10	[50 seconds]
11	[55 seconds]
12	[60 seconds]
<b>GET OUT A OSD TIMER</b> ←	
Show the current OSD menu timeout value.	
<b>SET OUT A OSD VPOSITION N1</b> ←	
Set the vertical position of the OSD menu.	
<b>N1</b> = 0~100	[Vertical position]
<b>GET OUT A OSD VPOSITION</b> ←	
Show the current vertical position of the OSD menu.	
<b>SET OUT A OSD HPOSITION N1</b> ←	
Set the horizontal position of the OSD menu.	
<b>N1</b> = 0~100	[Horizontal position]

COMMAND	
Description and Parameters	
<b>GET OUT A OSD HPOSITION</b> ←	
Show the current vertical position of the OSD menu.	
<b>SET OUT A OSD TRANSPARENCY LEVEL N1</b> ←	
Set the transparency level of the OSD menu.	
<b>N1</b> = 1~8	[Transparency level]
<b>GET OUT A OSD TRANSPARENCY LEVEL</b> ←	
Show the current transparency level of the OSD menu.	
<b>SET OUT A OSD DISPLAY N1</b> ←	
Enable/disable the info OSD, or set it to display briefly.	
Available values for <b>N1</b> :	
0	[Always off]
1	[Always on]
2	[Display briefly]
<b>GET OUT A OSD DISPLAY</b> ←	
Show the current info OSD state.	
<b>SET AUDIO OUT N1 MUTE N2</b> ←	
Enable or disable muting the specified audio output.	
Available values for <b>N1</b> :	
A	[HDMI audio output]
B	[HDBaseT audio output]
C	[Standard analogue audio output]
D	[Amplified analogue audio output]
Available values for <b>N2</b> :	
0	[Mute disabled]
1	[Mute enabled]
Note: The HDMI and HDBaseT outputs share their settings.	

COMMAND	
Description and Parameters	
<b>GET AUDIO OUT N1 MUTE</b> ←↵	
Show the current mute state of the specified output.	
Available values for <b>N1</b> :	
A	[HDMI audio output]
B	[HDBaseT audio output]
C	[Standard analogue audio output]
D	[Amplified analogue audio output]
<b>SET AUDIO OUT ALL MUTE N1</b> ←↵	
Enable or disable muting on all audio outputs.	
Available values for <b>N2</b> :	
0	[Mute disabled]
1	[Mute enabled]
<b>SET AUDIO OUT A ROUTE N1</b> ←↵	
Set the audio source selection behaviour of the unit.	
Available values for <b>N1</b> :	
0	[Follow user mode]
1	[Follow video mode]
2	[Analogue audio input 1]
3	[Analogue audio input 2]
4	[Analogue audio input 3]
5	[Analogue audio input 4]
6	[Analogue audio input 5]
7	[Analogue audio input 6]
<b>GET AUDIO OUT A ROUTE</b> ←↵	
Show the unit's current audio source selection behaviour.	



**COMMAND****Description and Parameters****SET AUDIO OUT N1 VOLUME N2** ←←

Set the volume level of the specified output's audio.

Available values for **N1**:

A	[HDMI audio output]
B	[HDBaseT audio output]
C	[Standard analogue audio output]
D	[Amplified analogue audio output]

**N2** = 0~100 [Volume level]

Note: The HDMI and HDBaseT outputs share their settings.

**GET AUDIO OUT N1 VOLUME** ←←

Show the current volume level of the specified output's audio.

Available values for **N1**:

A	[HDMI audio output]
B	[HDBaseT audio output]
C	[Standard analogue audio output]
D	[Amplified analogue audio output]

**GET AUDIO IN TYPE LIST** ←←

List all available audio input sources.

**GET AUDIO OUT TYPE LIST** ←←

List all available audio output destinations.

**SET AUDIO OUT MIXER N1** ←←

Set the state of the unit's audio mixer function.

Available values for **N1**:

0	[Mixer disabled]
1	[Mixer enabled]
2	[Microphone only]

COMMAND	
Description and Parameters	
<b>GET AUDIO OUT MIXER</b> ↵	
Show the current state of the unit's audio mixer.	
<b>SET HDMI OUT AUDIO BYPASS N1</b> ↵	
Enable or disable the HDMI/HDBaseT audio output bypass mode.	
Available values for <b>N1</b> :	
0	[Audio bypass disabled]
1	[Audio bypass enabled]
<b>GET HDMI OUT AUDIO BYPASS</b> ↵	
Show the current HDMI/HDBaseT audio output bypass mode state.	
<b>SET VIDEO IN N1 AUDIO ROUTE N2</b> ↵	
Set the audio source to use with the specified video input when Follow User Mode is enabled.	
Available values for <b>N1</b> :	
1	[USB-C input]
2	[HDBaseT input 1]
3	[HDBaseT input 2]
4	[HDMI input 1]
5	[HDMI input 2]
6	[HDMI input 3]
7	[HDMI input 4]
8	[VGA input 1]
9	[VGA input 2]

COMMAND	
Description and Parameters	
Available values for <b>N2</b> :	
0	[Analogue audio input 1]
1	[Analogue audio input 2]
2	[Analogue audio input 3]
3	[Analogue audio input 4]
4	[Analogue audio input 5]
5	[Analogue audio input 6]
6	[Embedded audio]
<b>GET VIDEO IN N1 AUDIO ROUTE</b> ←↵	
Show the audio source currently assigned to the specified video input to be used when Follow User Mode is enabled.	
Available values for <b>N1</b> :	
1	[USB-C input]
2	[HDBaseT input 1]
3	[HDBaseT input 2]
4	[HDMI input 1]
5	[HDMI input 2]
6	[HDMI input 3]
7	[HDMI input 4]
8	[VGA input 1]
9	[VGA input 2]
<b>SET AUDIO MIC GAIN N1</b> ←↵	
Set the gain level for the microphone input.	
<b>N1</b> = 0~100	[Microphone gain]
<b>GET AUDIO MIC GAIN</b> ←↵	
Show the current microphone input gain level.	

**COMMAND****Description and Parameters****SET IN N1 EDID N2↵**

Set the EDID to use on the specified input.

Available values for **N1**:

1	[USB-C input]
2	[HDBaseT input 1]
3	[HDBaseT input 2]
4	[HDMI input 1]
5	[HDMI input 2]
6	[HDMI input 3]
7	[HDMI input 4]
8	[VGA input 1]
9	[VGA input 2]

Available values for **N2**:

0	[Default FHD 2CH]
1	[Default FHD MCH]
2	[Default UHD 2CH]
3	[Default UHD MCH]
4	[Default UHD+ 2CH]
5	[Default UHD+ MCH]
6	[Default VGA]
7	[User EDID 1]
8	[User EDID 2]
9	[HDMI sink]
10	[HDBaseT sink]

**COMMAND****Description and Parameters****GET IN N1 EDID** ←

Show the EDID currently being used on the specified input.

Available values for **N1**:

1	[USB-C input]
2	[HDBaseT input 1]
3	[HDBaseT input 2]
4	[HDMI input 1]
5	[HDMI input 2]
6	[HDMI input 3]
7	[HDMI input 4]
8	[VGA input 1]
9	[VGA input 2]

**GET IN EDID LIST** ←

List all available EDID selections.

**SET IN N1 HDCP MODE N2** ←

Set the HDCP behaviour of the specified input.

Available values for **N1**:

1	[USB-C input]
2	[HDBaseT input 1]
3	[HDBaseT input 2]
4	[HDMI input 1]
5	[HDMI input 2]
6	[HDMI input 3]
7	[HDMI input 4]

Available values for **N2**:

0	[HDCP support disabled]
1	[HDCP support enabled]

**COMMAND****Description and Parameters****GET IN N1 HDCP MODE** ← ↵

Show the current HDCP behaviour used by the specified input.

Available values for **N1**:

1	[USB-C input]
2	[HDBaseT input 1]
3	[HDBaseT input 2]
4	[HDMI input 1]
5	[HDMI input 2]
6	[HDMI input 3]
7	[HDMI input 4]

**GET IN N1 HDCP STATUS** ← ↵

Show the current HDCP status of the specified input.

Available values for **N1**:

1	[USB-C input]
2	[HDBaseT input 1]
3	[HDBaseT input 2]
4	[HDMI input 1]
5	[HDMI input 2]
6	[HDMI input 3]
7	[HDMI input 4]

Possible response values:

0	[No HDCP]
1	[HDCP 1.x]
2	[HDCP 2.2]

COMMAND	
Description and Parameters	
<b>GET OUT N1 HDCP STATUS</b> ←	
Show the current HDCP status of the specified output.	
Available values for <b>N1</b> :	
A	[HDMI output]
B	[HDBaseT output]
Possible response values:	
0	[No HDCP]
1	[HDCP 1.x]
2	[HDCP 2.2]
3	[HDCP 1.x failed]
4	[HDCP 2.x failed]
<b>SET RELAY N1 N2</b> ←	
Open or close the specified relay.	
<b>N1</b> = 1~2	[Relay port number]
Available values for <b>N2</b> :	
ON	[Closed]
OFF	[Open]
<b>GET RELAY N1</b> ←	
Show the current state of the specified relay.	
<b>N1</b> = 1~2	[Relay port number]
<b>SET UART2 N1</b> ←	
Set the HDBaseT routing path for the unit's RS-232 port.	
Available values for <b>N1</b> :	
0	[HDBaseT Out]
1	[HDBaseT Input 1]
2	[HDBaseT Input 2]

COMMAND	
Description and Parameters	
<b>GET UART2↵</b>	Show the current HDBaseT routing path for the unit's RS-232 port.
<b>SET IR N1↵</b>	Set the HDBaseT routing path for the unit's IR ports.  Available values for <b>N1</b> :
0	[HDBaseT Out]
1	[HDBaseT Input 1]
2	[HDBaseT Input 2]
<b>GET IR↵</b>	Show the current HDBaseT routing path for the unit's IR ports.

*Note: Commands will not be executed unless followed by a carriage return. Commands are not case-sensitive.*



# 7. CONNECTION DIAGRAM

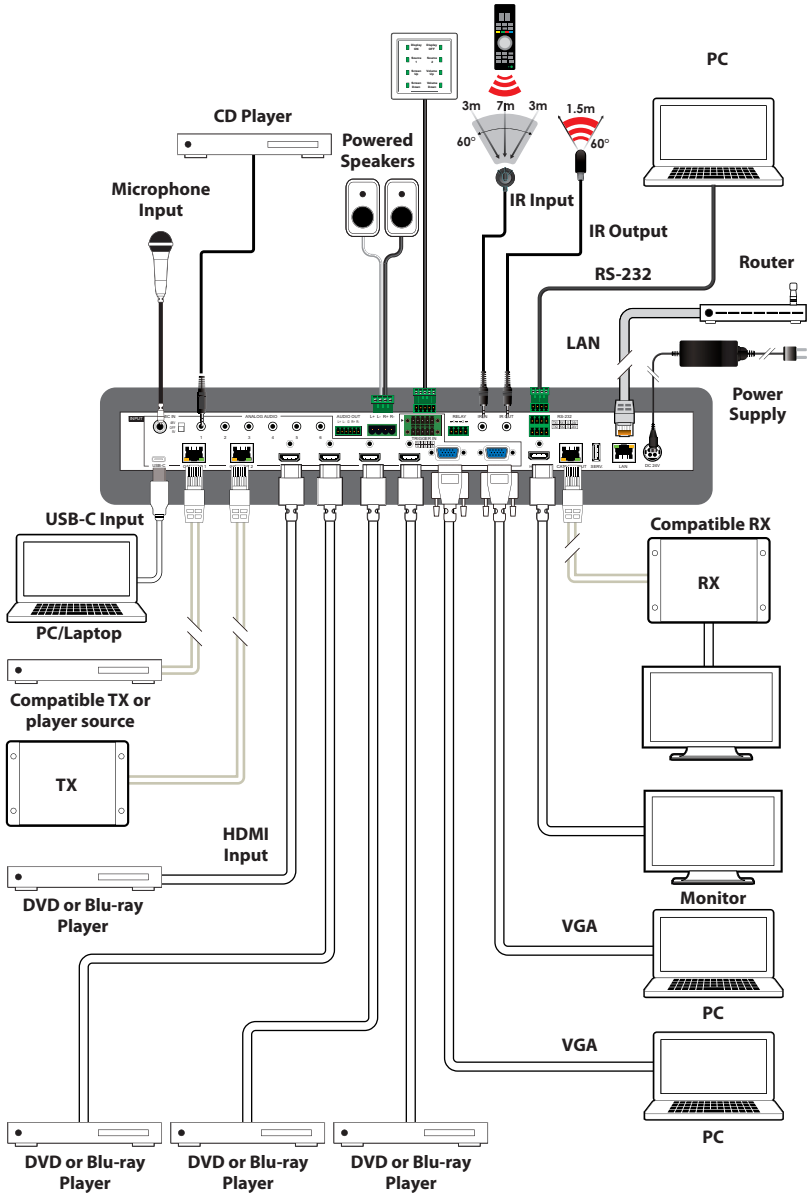

## 8. SPECIFICATIONS

### 8.1 Technical Specifications

<b>HDMI Bandwidth</b>	18Gbps
<b>USB-C Bandwidth</b>	21.6Gbps
<b>VGA Bandwidth</b>	165MHz
<b>HDBaseT Bandwidth</b>	10.2Gbps
<b>Input Ports</b>	1×USB (Type-C) 2×HDBaseT (RJ-45) 4×HDMI (Type-A) 2×VGA (HD-15) 6×Stereo Audio (3.5mm) 1×Microphone (6.35mm)
<b>Output Ports</b>	1×HDMI (Type-A) 1×HDBaseT (RJ-45) 1×Stereo Audio (5-pin Terminal Block) 1×Stereo Audio (2×2-pin Term. Blocks)
<b>Pass-through Ports</b>	1×IR Extender (3.5mm) 1×IR Blaster (3.5mm) 1×RS-232 (4-pin Terminal Block) 2×Power Relay (2-pin Terminal Block)
<b>Pass-through/Control Port</b>	1×LAN (RJ-45)
<b>Control Ports</b>	1×RS-232 (4-pin Terminal Block) 1×Trigger (10-pin Terminal Block)
<b>Service Port</b>	1×USB 2.0 (Type A)
<b>IR Frequency</b>	30 – 50kHz (30 – 60kHz under ideal conditions)
<b>Baud Rate</b>	Up to 115200 (19200 Control Default)
<b>Power Supply</b>	24V/6.25A DC (US/EU standards, CE/FCC/UL certified)

<b>ESD Protection (HBM)</b>	±8kV (Air Discharge) ±4kV (Contact Discharge)
<b>Dimensions (W×H×D)</b>	432mm×43mm×164mm [Case Only] 432mm×43mm×174mm [All Inclusive]
<b>Weight</b>	2547g
<b>Chassis Material</b>	Metal (Steel)
<b>Chassis Colour</b>	Black
<b>Operating Temperature</b>	0 °C – 40 °C/32 °F – 104 °F
<b>Storage Temperature</b>	–20 °C – 60°C/–4 °F – 140 °F
<b>Relative Humidity</b>	20 – 90 % RH (Non-condensing)
<b>Power Consumption</b>	53.966W

## 8.2 Video Specifications

### 8.2.1 Bypass Output

Supported Resolutions (Hz)	Input				Bypass Output	
	HDMI	HDBT	USBC	VGA	HDMI	HDBT
<b>720x400p@70/85</b>	✓	✓	✓	✓	✓	✓
<b>640x480p@60/72/75/85</b>	✓	✓	✓	✓	✓	✓
<b>720x480i@60</b>	✓	✓	✓	✗	✓	✓
<b>720x480p@60</b>	✓	✓	✓	✓	✓	✓
<b>720x576i@50</b>	✓	✓	✓	✗	✓	✓
<b>720x576p@50</b>	✓	✓	✓	✓	✓	✓
<b>800x600p@56/60/72/ 75/85</b>	✓	✓	✓	✓	✓	✓
<b>848x480p@60</b>	✓	✓	✓	✓	✓	✓
<b>1024x768p@60/70/75/85</b>	✓	✓	✓	✓	✓	✓
<b>1152x864p@75</b>	✓	✓	✓	✓	✓	✓
<b>1280x720p@50/60</b>	✓	✓	✓	✓	✓	✓
<b>1280x768p@60/75/85</b>	✓	✓	✓	✓	✓	✓
<b>1280x800p@60/75/85</b>	✓	✓	✓	✓	✓	✓
<b>1280x960p@60/85</b>	✓	✓	✓	✓	✓	✓
<b>1280x1024p@60/75/85</b>	✓	✓	✓	✓	✓	✓
<b>1360x768p@60</b>	✓	✓	✓	✓	✓	✓
<b>1366x768p@60</b>	✓	✓	✓	✓	✓	✓
<b>1400x1050p@60</b>	✓	✓	✓	✓	✓	✓
<b>1440x900p@60/75</b>	✓	✓	✓	✓	✓	✓
<b>1600x900p@60RB</b>	✓	✓	✓	✓	✓	✓
<b>1600x1200p@60</b>	✓	✓	✓	✓	✓	✓

Supported Resolutions (Hz)	Input				Bypass Output	
	HDMI	HDBT	USBC	VGA	HDMI	HDBT
<b>1680×1050p@60</b>	✓	✓	✓	✓	✓	✓
<b>1920×1080i@50/60</b>	✓	✓	✓	✓	✓	✓
<b>1920×1080p@24/25/30</b>	✓	✓	✓	✓	✓	✓
<b>1920×1080p@50/60</b>	✓	✓	✓	✓	✓	✓
<b>1920×1200p@60RB</b>	✓	✓	✓	✓	✓	✓
<b>2560×1440p@60RB</b>	✓	✓	✓	✗	✓	✓
<b>2560×1600p@60RB</b>	✓	✓	✓	✗	✓	✓
<b>2048×1080p@24/25/30</b>	✓	✓	✓	✗	✓	✓
<b>2048×1080p@50/60</b>	✓	✓	✓	✗	✓	✓
<b>3840×2160p@24/25/30</b>	✓	✓	✓	✗	✓	✓
<b>3840×2160p@50/60 (4:2:0)</b>	✓	✓	✓	✗	✓	✓
<b>3840×2160p@24, HDR10</b>	✓	✗	✓	✗	✓	8-bit
<b>3840×2160p@50/60 (4:2:0), HDR10</b>	✓	✗	✓	✗	✓	8-bit
<b>3840×2160p@50/60</b>	✓	✗	✓	✗	✓	✗
<b>4096×2160p@24/25/30</b>	✓	✓	✓	✗	✓	✓
<b>4096×2160p@50/60 (4:2:0)</b>	✓	✓	✓	✗	✓	✓
<b>4096×2160p@24, HDR10</b>	✓	✗	✓	✗	✓	8-bit
<b>4096×2160p@50/60 (4:2:0), HDR10</b>	✓	✗	✓	✗	✓	8-bit
<b>4096×2160p@50/60</b>	✓	✗	✓	✗	✓	✗

## 8.2.2 Scaled Output

Supported Resolutions (Hz)	Scaled Output	
	HDMI	HDBT
<b>720x400p@70/85</b>	×	×
<b>640x480p@60/72/75/85</b>	60	60
<b>720x480i@60</b>	×	×
<b>720x480p@60</b>	✓	✓
<b>720x576i@50</b>	×	×
<b>720x576p@50</b>	✓	✓
<b>800x600p@56/60/72/75/85</b>	60	60
<b>848x480p@60</b>	×	×
<b>1024x768p@60/70/75/85</b>	60	60
<b>1152x864p@75</b>	×	×
<b>1280x720p@50/60</b>	✓	✓
<b>1280x768p@60/75/85</b>	60	60
<b>1280x800p@60/75/85</b>	60	60
<b>1280x960p@60/85</b>	×	×
<b>1280x1024p@60/75/85</b>	60	60
<b>1360x768p@60</b>	✓	✓
<b>1366x768p@60</b>	×	×
<b>1400x1050p@60</b>	✓	✓
<b>1440x900p@60/75</b>	60	60
<b>1600x900p@60RB</b>	×	×
<b>1600x1200p@60</b>	✓	✓
<b>1680x1050p@60</b>	✓	✓
<b>1920x1080i@50/60</b>	×	×

Supported Resolutions (Hz)	Scaled Output	
	HDMI	HDBT
<b>1920×1080p@24/25/30</b>	✓	✓
<b>1920×1080p@50/60</b>	✓	✓
<b>1920×1200p@60RB</b>	✓	✓
<b>2560×1440p@60RB</b>	×	×
<b>2560×1600p@60RB</b>	✓	✓
<b>2048×1080p@24/25/30</b>	×	×
<b>2048×1080p@50/60</b>	×	×
<b>3840×2160p@24/25/30</b>	✓	✓
<b>3840×2160p@50/60 (4:2:0)</b>	✓	✓
<b>3840×2160p@24, HDR10</b>	×	×
<b>3840×2160p@50/60 (4:2:0), HDR10</b>	×	×
<b>3840×2160p@50/60</b>	✓	×
<b>4096×2160p@24/25/30</b>	✓	✓
<b>4096×2160p@50/60 (4:2:0)</b>	✓	✓
<b>4096×2160p@24, HDR10</b>	×	×
<b>4096×2160p@50/60 (4:2:0), HDR10</b>	×	×
<b>4096×2160p@50/60</b>	✓	×

## 8.3 Audio Specifications

### 8.3.1 Digital Audio

HDMI Input / Output	
LPCM	
<b>Max Channels</b>	2 Channels (8 Channels in bypass)
<b>Sampling Rate (kHz)</b>	32, 44.1, 48, 88.2, 96, 176.4, 192
Bitstream (Bypass Only)	
<b>Supported Formats</b>	Standard & High-Definition
HDBaseT Input / Output	
LPCM	
<b>Max Channels</b>	2 Channels (8 Channels in bypass)
<b>Sampling Rate (kHz)</b>	32, 44.1, 48, 88.2, 96, 176.4, 192
Bitstream (Bypass Only)	
<b>Supported Formats</b>	Standard & High-Definition
USB-C Input	
LPCM	
<b>Max Channels</b>	2 Channels (8 Channels in bypass)
<b>Sampling Rate (kHz)</b>	32, 44.1, 48, 88.2, 96, 176.4, 192
Bitstream (Bypass Only)	
<b>Supported Formats</b>	Standard & High-Definition



### 8.3.2 Analogue Audio

Analogue Input (3.5mm)	
<b>Max Audio Level</b>	1Vrms
<b>Impedance</b>	10k $\Omega$
<b>Type</b>	Unbalanced
Mic Input	
<b>Max Audio Level</b>	50Vrms
<b>Impedance</b>	6.8k $\Omega$
<b>Type</b>	Unbalanced
Analogue Output (5-pin Terminal Block)	
<b>Max Audio Level</b>	4Vrms
<b>THD+N</b>	< -84dB@0dBFS 1kHz (A-wt)
<b>SNR</b>	> 104dB@0dBFS
<b>Frequency Response</b>	< $\pm 3$ dB@20Hz~20kHz
<b>Crosstalk</b>	< -70dB@10kHz
<b>Impedance</b>	499 $\Omega$
<b>Type</b>	Balanced
Amplified Analogue Output (2-pin Terminal Block Pair)	
<b>Max Audio Level</b>	20W
<b>THD+N</b>	< -66dB@20W 1kHz (A-wt)
<b>SNR</b>	> 96dB@0dBFS
<b>Frequency Response</b>	< $\pm 3$ dB@20Hz~20kHz
<b>Crosstalk</b>	< -70dB@10kHz
<b>Impedance</b>	4 $\Omega$
<b>Type</b>	Balanced

## 8.4 Cable Specifications

Cable Length	1080p		4K30	4K60
	8-bit	12-bit	(4:4:4) 8-bit	(4:4:4) 8-bit
<b>High Speed HDMI Cable</b>				
<b>HDMI Input</b>	15m	10m	5m	3m
<b>HDMI Output</b>	15m	10m	5m	3m
<b>USB-C Cable</b>				
<b>USB-C Input</b>	1m			
<b>VGA Cable</b>				
<b>VGA Input</b>	2m		x	
<b>Ethernet Cable</b>				
<b>Cat.5e/6</b>	100m		70m	x
<b>Cat.6A/7</b>	100m		100m	x

### Bandwidth Category Examples:

#### 1080p (FHD Video)

- Up to 1080p@60Hz, 12-bit colour
- Data rates lower than 5.3Gbps or below 225MHz TMDS clock

#### 4K30 (UHD Video)

- 4K@24/25/30Hz & 4K@50/60Hz (4:2:0), 8-bit colour
- Data rates higher than 5.3Gbps or above 225MHz TMDS clock but below 10.2Gbps

#### 4K60 (UHD<sup>+</sup> Video)

- 4K@50/60Hz (4:4:4, 8-bit)
- 4K@50/60Hz (4:2:0, 10-bit HDR)
- Data rates higher than 10.2Gbps

## 8.5 HDBaseT Features

HDBaseT Feature Set	Transmitter
<b>Video &amp; Audio Extension</b>	Supported
<b>LAN Extension</b>	Supported
<b>Send power to Receiver</b>	Supported (PoH)
<b>Accept power from Receiver</b>	Unsupported
<b>IR Extension</b>	Supported
<b>RS-232 Extension</b>	Supported
<b>USB 2.0 Extension</b>	Unsupported

HDBaseT Feature Set	Receiver
<b>Video &amp; Audio Extension</b>	Supported
<b>LAN Extension</b>	Supported
<b>Send power to Transmitter</b>	Supported (PoH)
<b>Accept power from Transmitter</b>	Unsupported
<b>IR Extension</b>	Supported
<b>RS-232 Extension</b>	Supported
<b>USB 2.0 Extension</b>	Unsupported

## 9. ACRONYMS

ACRONYM	COMPLETE TERM
<b>ADC</b>	Analogue-to-Digital Converter
<b>ASCII</b>	American Standard Code for Information Interchange
<b>Cat.5e</b>	Enhanced Category 5 cable
<b>Cat.6</b>	Category 6 cable
<b>Cat.6A</b>	Augmented Category 6 cable
<b>Cat.7</b>	Category 7 cable
<b>CLI</b>	Command-Line Interface
<b>DAC</b>	Digital-to-Analogue Converter
<b>dB</b>	Decibel
<b>DHCP</b>	Dynamic Host Configuration Protocol
<b>DVI</b>	Digital Visual Interface
<b>EDID</b>	Extended Display Identification Data
<b>Gbps</b>	Gigabits per second
<b>GUI</b>	Graphical User Interface
<b>HDBT</b>	HDBaseT
<b>HDCP</b>	High-bandwidth Digital Content Protection
<b>HDMI</b>	High-Definition Multimedia Interface
<b>HDR</b>	High Dynamic Range
<b>HDTV</b>	High-Definition Television
<b>HPD</b>	Hot Plug Detection
<b>IP</b>	Internet Protocol
<b>IR</b>	Infrared
<b>kHz</b>	Kilohertz
<b>LAN</b>	Local Area Network

<b>ACRONYM</b>	<b>COMPLETE TERM</b>
<b>LCD</b>	Liquid-Crystal Display
<b>LED</b>	Light-Emitting Diode
<b>LPCM</b>	Linear Pulse-Code Modulation
<b>MAC</b>	Media Access Control
<b>MHz</b>	Megahertz
<b>OSD</b>	On-Screen Display
<b>PD</b>	Powered Device
<b>PoH</b>	Power over HDBaseT
<b>PSE</b>	Power Sourcing Equipment
<b>SNR</b>	Signal-to-Noise Ratio
<b>TCP</b>	Transmission Control Protocol
<b>THD+N</b>	Total Harmonic Distortion plus Noise
<b>TMDS</b>	Transition-Minimised Differential Signaling
<b>UHD</b>	Ultra-High-Definition (10.2Gbps)
<b>UHD<sup>+</sup></b>	Ultra-High-Definition Plus (18Gbps)
<b>UHDTV</b>	Ultra-High-Definition Television
<b>USB</b>	Universal Serial Bus
<b>VGA</b>	Video Graphics Array
<b>WUXGA (RB)</b>	Widescreen Ultra Extended Graphics Array (Reduced Blanking)
<b>XGA</b>	Extended Graphics Array
<b>Ω</b>	Ohm







---

CYP (UK) Ltd., Unit 7, Shepperton Business Park, Govett Avenue, Shepperton,  
Middlesex, TW17 8BA

Tel: +44 (0) 20 3137 9180 | Fax: +44 (0) 20 3137 6279

Email: [sales@cypeurope.com](mailto:sales@cypeurope.com)

[www.cypeurope.com](http://www.cypeurope.com)

v1.00