

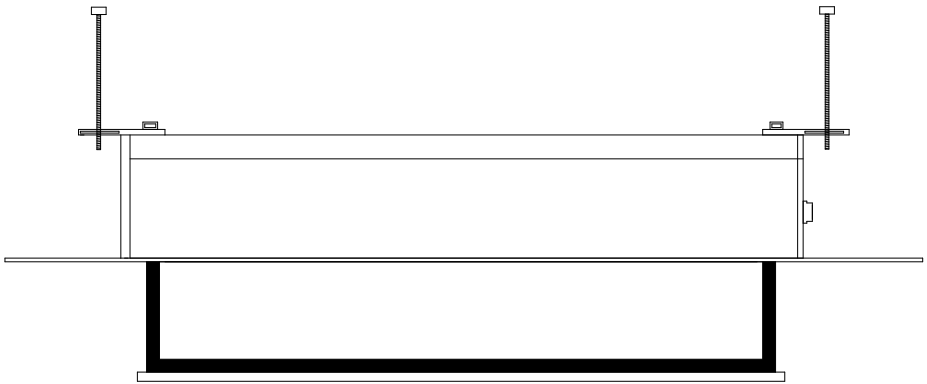

Installation Guide

celexon ceiling recessed electric
Professional Plus screen



Thank you for purchasing this celexon product. Before installing the projector screen, please read the following instructions carefully and keep for future reference.

DE:

Auf <http://www.celexon.de> finden Sie durch Eingabe der Identifikationsnummer „CX1005“ im Suchfeld die aktuelle Version dieser Bedienungsanleitung in Ihrer jeweiligen Landessprache zum Download.

Die Konformitätserklärung und die zu diesem Produkt gültigen Zertifizierungen sind auf unserer Webseite <http://de.celexon.com> einsehbar.

EN:

At www.celexon.co.uk you can find the latest version of the manual and download it simply by searching the identification number “CX1005” in the search field.

The declaration of conformity and the relevant certificates for this product are available on our website <http://de.celexon.com>.

FR:

En vous rendant sur <http://www.celexon.fr> et en entrant le numéro d'identification „CX1005“ dans la barre de recherche, vous pourrez télécharger la version française la plus actuelle de cette notice d'utilisation.

La déclaration de conformité ainsi que les certificats en cours de validité de ce produit sont disponibles sur notre site internet <http://fr.celexon.com>.

NL:

Op <http://www.celexon.nl> vind u door ingave van het identificatienummer „CX1005“ in het zoekveld de actuele versie van deze gebruikershandleiding in uw taal als download. De conformiteitsverklaring en de voor dit product geldige certificaten kunnen op onze website <http://nl.celexon.com> worden ingezien.

SE:

På <http://uk.celexon.com> hittar du den aktuella versionen av din bruksanvisning på ditt spårk för nedladdning genom att skriva in identifikationsnumret „CX1005“ i sökrutan. Försäkran om överensstämmelse och de giltiga certifikaten för denna produkt kan hittas på hemsidan <http://uk.celexon.com>.

PL:

Na stronie <http://www.celexon.pl> znajdą Państwo aktualną wersję instrukcji obsługi. W polu szukaj należy podać następujący numer: „CX1005“.

Deklaracja zgodności oraz certyfikaty dotyczące produktu są dostępne na stronie <http://de.celexon.com>.

ES:

Puede descargar la versión actual de este manual de uso, en el idioma correspondiente en <http://www.celexon.de> introduciendo el código de identificación “CX1005” en la barra de búsqueda.

Puede encontrar la declaración de conformidad y los certificados correspondientes para este producto en nuestra página web <http://es.celexon.com>.

Safety instructions

- Do not start installation before reading the complete installation manual and the safety warnings.
- This product should only be installed by qualified personnel (with mechanical and electrical experience).
- If necessary, carry out the installation with another person to ensure safe installation.
- Tighten the screws but ensure that they are not overtightened as this may cause damage.
- This product is designed for indoor use only. Outdoor use could result in damage to the product and may cause injury.
- Hanging loads must be tested at least twice a year for strength and carrying capacity.

Disclaimer

The information in this document is subject to change without prior notice. Changes will be documented in future editions of this manual. The manufacturer does not guarantee accuracy of the information contained in this document.

Important

Please read the following instructions carefully and keep them for future reference. The manufacturer does not accept liability for any damage to property or personal injury if the screen is used outside of the recommended specifications, or if it is installed improperly.

Do not use the screen near extreme temperatures (radiators or air conditioning units). Do not install the screen in direct sunlight or in front of a window. Due to the temperature-sensitive PVC surface, damage may occur to the projection fabric.

We recommend to wait approx. 2 hours after delivery of the screen before you start installation so that the fabric can acclimatise, particularly when the fabric came in from a cold environment to a warm one.

Please avoid any stains on the fabric as it may not be possible to remove them.

Cleaning instructions

Never clean the screen with alcohol or other cleaning agents containing solvents. Use only a soft and clean cloth with a mild soapy solution. Avoid contact with pointed or sharp objects. These could damage the fabric.

In the box

Prior to installation, please check that you have all the piece parts listed below. If any piece parts are missing, please contact the dealer where you purchased the product and wait with the installation until you have received the missing part.

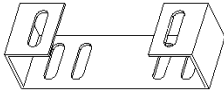

2 x Mounting brackets (A)

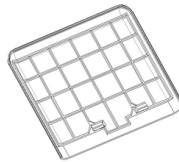

2 x Inspection covers (B)

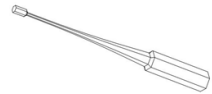

1 x Allen Key Tool
(for end stop
positions) (C)



4 x Threaded rod (D)



4 x Wall plugs (E)



1 x Allen key (5mm) (F)



1 x Allen key (8mm) (L)

Installation of screen

1. Take the cut-out dimensions from the list below and cut an appropriate hole into your suspended ceiling.

Width Viewing area	Length Ceiling cut-out	Width Ceiling cut-out
160 cm	202 cm	11 cm
180 cm	222 cm	11 cm
200 cm	244 cm	11 cm
220 cm	264 cm	11 cm
240 cm	284 cm	11 cm
280 cm	329 cm	13,5 cm
300 cm	349 cm	13,5 cm

Alternatively, you can determine the cut-out dimensions as follows:

Measure the length „**L**“ as well as the depth „**CD**“ of the screen housing as shown in the two figures below. Add 190mm to length „**L**“ and deduct 25mm from the width „**CD**“.

Installation of screen

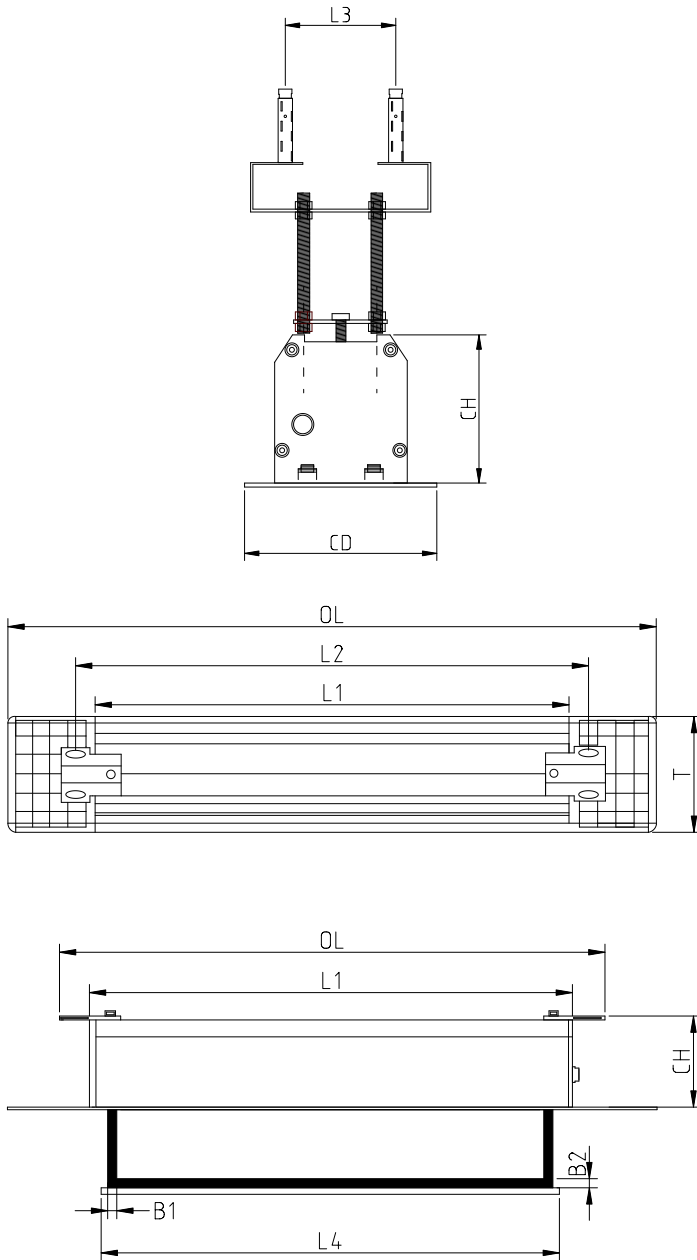

Figure 1

Installation of screen

2. Loosen the screws of the mounting plate above the screen housing. Slide the mounting plates to the ends of the housing and tighten the screws again (Figure 2). Please ensure that the holes for the threaded rods are not covered by the housing.

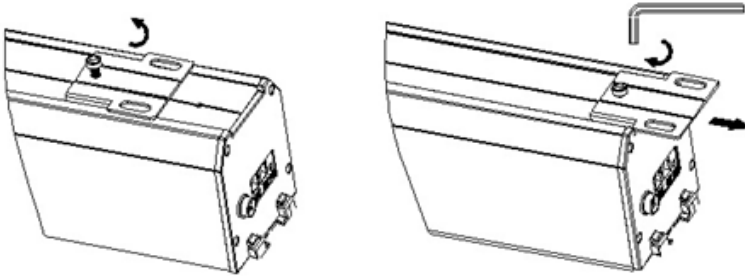

Figure 2

3. Drill 4 holes in the load bearing ceiling and insert the wall plugs E. The distance between the holes should be $L + 40\text{mm} \times 94\text{mm}$. If necessary, use other wall plugs and screws suitable for your specific requirements.

Now attach the two mounting brackets (A) to your ceiling. Please ensure that brackets are securely fastened and provide a safe installation. Then attach the 4 threaded rods (D) to the mounting brackets and attach a nut to each rod (Fig 3).

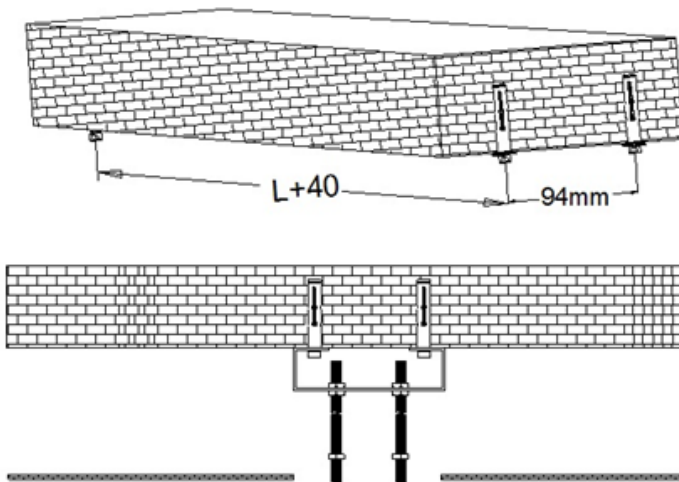

Figure 3

Installation of screen

4. Insert the housing into the ceiling cut-out. Please ensure that the four threaded rods are inserted into the holes of the mounting brackets. Tighten the nuts on each threaded rod to secure the screen (see fig 4).

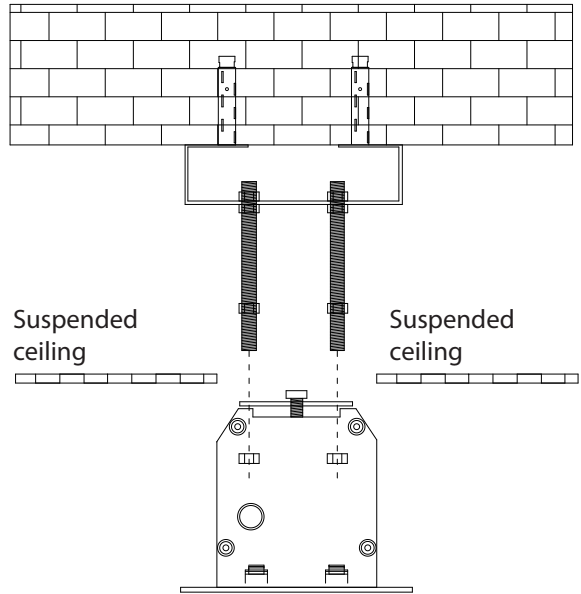

Figure 4

5. Move the screen into a horizontal position tightening the nuts and eliminating any gap between the ceiling and the trim (Fig 5). Use a spirit level to ensure that the screen is perfectly horizontal.

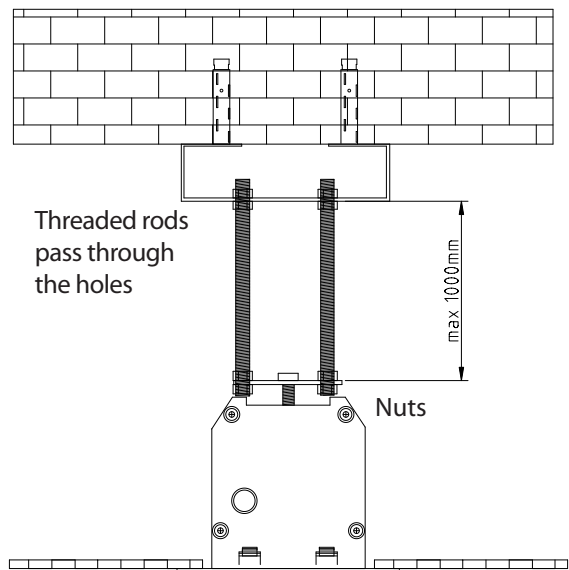

Figure 5

Installation of screen

- Finally attach the inspection covers (B) to the sides of the housing. To dismantle the screen, pull the covers down and away from the housing (Fig 6).

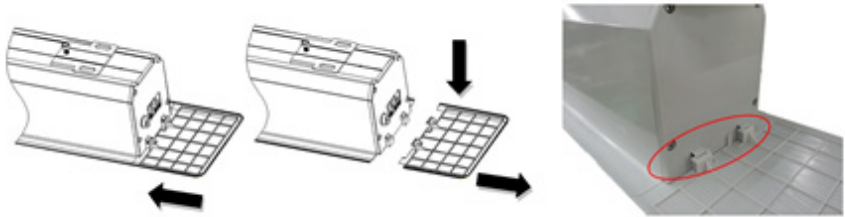

Figure 6

This completes the installation.

Screen operation

Operating the screen via wall switch

Plug the power cable into the socket (ensure correct voltage). Position the cable so that it does not present a hazard or comes into contact with hot surfaces. You may require an extension lead.

To lower the screen (see fig 2)

When you set the switch to < + >, the screen will come down and stop automatically at the lower stop position.

To retract the screen (see fig 3)

When you position the switch to < - >, the screen will automatically retract into its housing and stop at the upper stop position.

To stop the screen

If you position the switch to < 0 >, the screen will stop at that position.

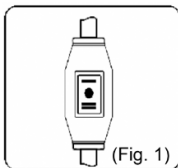

(Fig. 1)

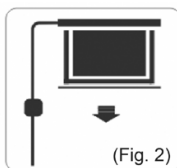

(Fig. 2)

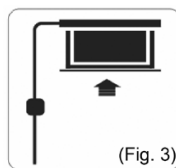

(Fig. 3)

Installation of screen

Wireless operation (fig 4) (Optional)

To lower the screen:

If you press the lower button on the remote control, the screen will automatically lower itself and stop at the lower stop position (when fully extended).

To retract the screen:

If you press the top button on the remote control, the screen will automatically retract into its housing and stop when fully retracted.

To stop the screen:

If you wish to stop the screen, then press the middle button on your remote control.

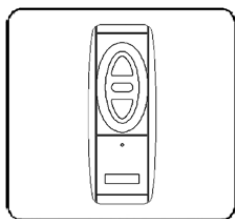

(Fig. 4)

To adjust the stop positions

Please note that any damage caused by incorrect tempering of the stop positions will not be covered under the warranty.



Lower Limit — Adjusting the lower stop limit is only possible when the screen is fully extended. To extend the lower limit, turn the 'lower limit' Allen key hole clockwise.

Upper Limit — Adjusting the upper stop limit is only possible when the screen is fully retracted into the housing. To adjust the upper limit, turn the 'upper limit' Allen key hole clockwise.

Dimensions

Product descriptions (W x H)	Dimensions L1	Dimensions L2	Dimensions L3	Width L4	Housing dimensions (OlxCHxCD)	Ceiling cut-out dimensions
160x160 cm	182,6 cm	186,6 cm	9,4 cm	172,2 cm	206,6x10,3x13,6 cm	201,6x11,1 cm
180x180 cm	202,6 cm	206,6 cm	9,4 cm	192,2 cm	226,6x10,3x13,6 cm	221,6x11,1 cm
200x200 cm	224,6 cm	228,6 cm	9,4 cm	214,2 cm	248,6x10,3x13,6 cm	243,6x11,1 cm
220x220 cm	244,6 cm	248,6 cm	9,4 cm	234,2 cm	268,6 x10,3x13,6 cm	263,6x11,1 cm
240x240 cm	264,6 cm	268,6 cm	9,4 cm	254,2 cm	288,6x10,3x13,6 cm	283,6x11,1 cm
280x280 cm	309,8 cm	313,8 cm	9,4 cm	296,3 cm	312,4x12,7x16,0 cm	328,8x13,5 cm
160x120 cm	182,6 cm	186,6 cm	9,4 cm	172,2 cm	206,6x10,3x13,6 cm	201,6x11,1 cm
180x135 cm	202,6 cm	206,6 cm	9,4 cm	192,2 cm	226,6x10,3x13,6 cm	221,6x11,1 cm
200x150 cm	224,6 cm	228,6 cm	9,4 cm	214,2 cm	248,6x10,3x13,6 cm	234,6x11,1 cm
220x165 cm	244,6 cm	248,6 cm	9,4 cm	234,2 cm	268,6x10,3x13,6 cm	263,6x11,1 cm
240x280 cm	264,6 cm	268,6 cm	9,4 cm	254,2 cm	288,6x10,3x13,6 cm	283,6x11,1 cm
280x210 cm	309,8 cm	313,8 cm	9,4 cm	296,3 cm	312,4x12,7x16,0 cm	328,8x13,5 cm
300x225 cm	329,8 cm	333,8 cm	9,4 cm	316,3 cm	339,5x12,7x16,0 cm	348,8x13,5 cm
160x90 cm	182,6 cm	186,6 cm	9,4 cm	172,2 cm	206,6x10,3x13,6 cm	201,6x11,1 cm
180x102 cm	202,6 cm	206,6 cm	9,4 cm	192,2 cm	226,6x10,3x13,6 cm	221,6x11,1 cm
200x113 cm	224,6 cm	228,6 cm	9,4 cm	214,2 cm	248,6x10,3x13,6 cm	243,6x11,1 cm
220x124 cm	244,6 cm	248,6 cm	9,4 cm	234,2 cm	268,6x10,3x13,6 cm	263,6x11,1 cm
240x135 cm	264,6 cm	268,6 cm	9,4 cm	254,2 cm	288,6x10,3x13,6 cm	283,6x11,1 cm
280x158 cm	309,8 cm	313,8 cm	9,4 cm	296,3 cm	312,4x12,7x16,0 cm	328,8x13,5 cm
300x169 cm	329,8 cm	333,8 cm	9,4 cm	316,3 cm	339,5x12,7x16,0 cm	348,8x13,5 cm
160x110 cm	182,6 cm	186,6 cm	9,4 cm	172,2 cm	206,6x10,3x13,6 cm	201,6x11,1 cm
180x112 cm	202,6 cm	206,6 cm	9,4 cm	192,2 cm	226,6x10,3x13,6 cm	221,6x11,1 cm
200x125 cm	224,6 cm	228,6 cm	9,4 cm	214,2 cm	248,6x10,3x13,6 cm	243,6x11,1 cm
220x137 cm	244,6 cm	248,6 cm	9,4 cm	234,2 cm	268,6x10,3x13,6 cm	263,6x11,1 cm
240x150 cm	264,6 cm	268,6 cm	9,4 cm	254,2 cm	288,6x10,3x13,6 cm	283,6x11,1 cm
280x175 cm	309,8 cm	313,8 cm	9,4 cm	296,3 cm	312,4x12,7x16,0 cm	328,8x13,5 cm
300x187 cm	329,8 cm	333,8 cm	9,4 cm	316,3 cm	339,5x12,7x16,0 cm	348,8x13,5 cm

Information on EU conformity

celexon declares that this product complies with the EU directive on electromagnetic compatibility (EMC) and the EU Low Voltage Directive (LVD).

A copy of the declaration of conformity can be found at www.celexon.co.uk --> Service --> Certificates.

celexon Germany GmbH & Co. KG