



User's Guide

Multimedia Projector

EB-1450Ui

EB-1440Ui

Notations Used in This Guide 8

Introduction to Your Projector 9

Projector Features..... 10

- Unique Interactive Functions..... 10
- Quick and Easy Setup 10
- Flexible Connectivity..... 10
 - Connect with Computers 11
 - Connect with Mobile Devices 11
- Easy Operation from the Control Pad 12
- Large-scale Presentation from the Whiteboard 12

Projector Parts and Functions 13

- Projector Parts - Front/Side 13
- Projector Parts - Top/Side 14
- Projector Parts - Interface..... 15
- Projector Parts - Base 17
- Projector Parts - Control Panel..... 17
- Projector Parts - Remote Control 18
- Projector Parts - Interactive Pens 20
- Projector Parts - Pen Stand..... 21
- Projector Parts - Control Pad..... 21
- Projector Parts - Touch Unit 22

Setting Up the Projector 24

Projector Placement 25

- Projector Setup and Installation Options..... 25
- Settings when Using the Interactive Features 26
 - Settings when Using the Touch Unit..... 27

Projector Connections 28

- Connecting to a Computer..... 28

- Connecting to a Computer for VGA Video and Audio..... 28
- Connecting to a Computer for USB Video and Audio..... 29
- Connecting to a Computer for HDMI Video and Audio 30
- Connecting a Computer to the Control Pad..... 31
- Connecting to Smartphones or Tablets..... 32
- Connecting to Video Sources 32
 - Connecting to an HDMI Video Source 33
 - Connecting to a Component-to-VGA Video Source 33
 - Connecting to a Composite Video Source..... 34
- Connecting to External USB Devices 35
 - USB Device Projection 35
 - Connecting to a USB Device 35
 - Connecting a USB Flash Drive to the Control Pad..... 36
 - Disconnecting a USB Device 36
- Connecting a Printer to the Control Pad..... 37
- Connecting to a Document Camera 37
- Connecting an External USB Keyboard to the Control Pad 37
- Connecting to External Output Devices..... 38
 - Connecting to an External DVI Monitor..... 38
 - Connecting to a VGA Monitor 39
 - Connecting to External Speakers 40
- Connecting Multiple Projectors of the Same Model 40

Installing Batteries in the Remote Control 43

Installing Batteries in the Pens 44

Remote Control Operation 45

Using Basic Projector Features 46

Turning On the Projector 47

- Home Screen 48

Turning Off the Projector 50

Setting the Date and Time 51

- Selecting the Language for the Projector Menus 53**
- Projection Modes 54**
 - Changing the Projection Mode Using the Remote Control..... 54
 - Changing the Projection Mode Using the Menus..... 54
- Focusing the Image..... 56**
- Image Shape 59**
 - Correcting the Image Shape with the Keystone Buttons 59
 - Correcting the Image Shape with Quick Corner 60
 - Correcting Image Shape with Curved Surface 62
 - Loading Image Shape Setting from Memory 64
- Resizing the Image with the Buttons 66**
- Adjusting the Image Position 67**
- Selecting an Image Source 68**
- Image Aspect Ratio 70**
 - Changing the Image Aspect Ratio 70
 - Available Image Aspect Ratios 70
 - Projected Image Appearance with Each Aspect Mode 71
- Color Mode 72**
 - Changing the Color Mode 72
 - Available Color Modes..... 72
 - Setting Auto Iris 72
- Adjusting the Image Color 74**
 - Adjusting the Hue, Saturation, and Brightness..... 74
 - Adjusting the Gamma 75
- Controlling the Volume with the Volume Buttons 77**
- Using the Interactive Features 78**

- Interactive Feature Modes 79**
- Preparing Before Using Interactive Features..... 80**

- Safety Instructions for Interactive Features..... 80
- Using the Interactive Pens 80
 - Pen Calibration 82
 - Calibrating Automatically..... 82
 - Calibrating Manually 83
- Using Interactive Touch Operations with Your Finger 85
 - Calibrating for Touch Operations with Your Finger 87
 - Safety Instructions for Interactive Touch Operations 89
 - Laser Warning Labels 90
- Whiteboard Screens (Whiteboard Mode) 91**
 - Starting Whiteboard Mode..... 91
 - Safety Instructions for Whiteboard Mode..... 92
 - Whiteboard Mode Toolbar 92
 - Whiteboard Mode Bottom Toolbar 95
 - Projecting Scanned Images in Whiteboard Mode..... 97
 - Compatible File Types for Opening in Whiteboard Mode 98
 - Sharing Drawings Created in Whiteboard Mode 99
 - Saving Drawing Contents in Whiteboard Mode..... 99
 - Available File Format in Whiteboard Mode 101
 - Printing Drawing Contents in Whiteboard Mode..... 101
 - Available Printer Control Commands in Whiteboard Mode..... 102
 - Sending Emails in Whiteboard Mode..... 102
 - Creating an Address Book 104
 - Available Directory Service in Whiteboard Mode..... 104
 - Whiteboard Sharing with Other Devices 105
 - Sharing Whiteboard Screen with Other Devices 105
 - Connection to the Shared Whiteboard 108
 - Connecting to a Shared Whiteboard from a Projector..... 108
 - Available Features when Connecting to a Whiteboard Screen 109
 - Connecting to a Shared Whiteboard from a Computer or Other Device via a Web Browser 111
 - Supported Web Browsers for Sharing a Whiteboard 112
 - Toolbar for Whiteboard Screen Connecting via a Web Browser 112
- Draw on the Projected Image Using Annotation Mode..... 115**

Starting Annotation Mode	115
Annotation Mode Toolbar	116
Annotation Mode Bottom Toolbar.....	117
Using Drawing Contents of Annotation Mode.....	118
Saving Drawing Contents in Annotation Mode	118
Printing Drawing Contents in Annotation Mode.....	118
Control Computer Features from a Projected Screen (Computer Interactive Mode)	120
Computer Interactive Mode System Requirements	120
Using Computer Interactive Mode.....	121
Adjusting the Pen Operation Area.....	123
Installing Easy Interactive Driver on OS X	124
Switching the Interactive Mode	125
Selecting Network Device Display	126
Connecting to a Remote Computer	128
Remote Desktop Connection System Requirements.....	129
Remote Desktop Connection Restrictions	130
Using the Interactive Features over a Network.....	131
Precautions when Connecting to a Projector on a Different Subnet.....	131
Windows Pen Input and Ink Tools	132
Enabling Windows Pen Input and Ink Features	132
Using Windows Pen Input and Ink Features	133
Interactive Features when Projecting Two Images Simultaneously.....	134
Switching Split Screen Projection.....	134
Selecting Split Screen Settings for the Interactive Feature	135
Interactive Features when Projecting with Two Projectors	137
Using the Interactive Features Temporarily on Only One of the Projectors.....	137

Adjusting Projector Features	139
Projecting Two Images Simultaneously	140
Unsupported Input Source Combinations for Split Screen Projection	141
Split Screen Projection Restrictions	142
Projecting a PC Free Presentation	143
Supported PC Free File Types	143
Precautions on PC Free Projection.....	143
Starting a PC Free Slide Show	144
Starting a PC Free PDF File Presentation	145
Starting a PC Free Movie Presentation	147
PC Free Display Options.....	148
Shutting Off the Image and Sound Temporarily	150
Stopping Video Action Temporarily	151
Zooming Images.....	152
Using the Remote Control as a Wireless Mouse	153
Using the Remote Control as a Pointer	155
Saving a User's Logo Image	156
Saving a User Pattern	158
Using Multiple Projectors	159
Projector Identification System for Multiple Projector Control.....	159
Setting the Projector ID.....	159
Selecting the Projector You want to Operate.....	160
Adjusting Color Uniformity	161
Adjusting the Lamp's Brightness	163
Matching the Image Colors.....	164
Adjusting RGBCMY	165
Projector Security Features	167
Password Security Types.....	167
Setting a Password	167
Selecting Password Security Types	168

Entering a Password to Use the Projector	169
Locking the Projector's Buttons	169
Unlocking the Projector's Buttons	170
Installing a Security Cable	171

Using the Projector on a Network 172

Wired Network Projection..... 173

Connecting to a Wired Network	173
Selecting Wired Network Settings.....	173

Wireless Network Projection 176

Installing the Wireless LAN Module	176
Selecting Wireless Network Settings Manually	177
Selecting Wireless Network Settings in Windows.....	179
Selecting Wireless Network Settings in OS X.....	179
Setting Up Wireless Network Security	179
Supported Client and CA Certificates.....	181
Using a QR Code to Connect a Mobile Device	182
Using a USB Key to Connect a Windows Computer.....	182

Secure HTTP..... 184

Importing a Web Server Certificate Using the Menus	184
Supported Web Server Certificates	185

Monitoring and Controlling the Projector 186

EasyMP Monitor 187

Controlling a Networked Projector Using a Web Browser 188

Registering Digital Certificates from a Web Browser	189
---	-----

Setting Up Projector Network E-Mail Alerts 191

Network Projector E-mail Alert Messages	191
---	-----

Setting Up Monitoring Using SNMP..... 192

Using ESC/VP21 Commands 193

ESC/VP21 Command List	193
Cable Layouts	193

PJLink Support 195

Crestron RoomView Support 196

Setting Up Crestron RoomView Support.....	196
Controlling a Networked Projector Using Crestron RoomView.....	196
Crestron RoomView Operation Window.....	197
Crestron RoomView Tools Window.....	198

Setting Projector Event Schedules 200

Adjusting the Menu Settings 203

Using the Projector's Menus 204

Using the On-screen Keyboard..... 205

Available Text Using the On-screen Keyboard.....	205
--	-----

Image Quality Settings - Image Menu 206

Input Signal Settings - Signal Menu..... 208

Projector Feature Settings - Settings Menu 210

Projector Setup Settings - Extended Menu 213

Extended Menu - Easy Interactive Function Menu	216
General	216
PC Interactive.....	217
Extended Menu - Whiteboard Settings Menu	218
Whiteboard Settings Menu - Basic Menu	218
Whiteboard Settings Menu - Policy Menu.....	219
Whiteboard Settings Menu - Print Menu.....	220
Whiteboard Settings Menu - Save Menu	220
Whiteboard Settings Menu - Mail Menu.....	221
Whiteboard Settings Menu - Directory Menu.....	222
Whiteboard Settings Menu - Reset Menu.....	224

Projector Network Settings - Network Menu..... 225

Network Menu - Basic Menu	226
Network Menu - Wireless LAN Menu	227
Network Menu - Wired LAN Menu	229
Network Menu - Notifications Menu	230
Network Menu - Others Menu	231
Network Menu - Reset Menu.....	231
Projector Setup Settings - ECO Menu	233
Projector Information Display - Info Menu	235
Info Menu - Projector Info Menu	235
Event ID Code List.....	236
Projector Reset Options - Reset Menu	238
Copying Menu Settings Between Projectors (Batch Setup)	239
Transferring Settings From a USB Flash Drive	239
Batch Setup Error Notification	240

Maintaining the Projector 241

Cleaning the Projection Window.....	242
Cleaning the Obstacle Sensor.....	243
Cleaning the Projector Case.....	244
Air Filter and Vent Maintenance	245
Cleaning the Air Filter	245
Replacing the Air Filter	247
Projector Lamp Maintenance	249
Replacing the Lamp	250
Resetting the Lamp Timer	252
Replacing the Remote Control Batteries	254
Replacing the Interactive Pen Battery	255
Replacing the Interactive Pen Tip	256
Replacing the Soft Pen Tip	256

Replacing the Soft Pen Tip with the Hard Pen Tip.....	257
---	-----

Solving Problems 258

Projection Problems	259
Projector Indicator Status	260
Using the Projector Help Displays.....	262
Solving Image or Sound Problems.....	263
Solutions When No Image Appears.....	263
Solutions When Image is Incorrect Using the USB Display Function	263
Solutions When "No Signal" Message Appears	264
Displaying From a Laptop.....	264
Displaying From a Mac Laptop.....	265
Solutions When "Not Supported" Message Appears	265
Solutions When Only a Partial Image Appears.....	265
Solutions When the Image is not Rectangular.....	265
Solutions When the Image Contains Noise or Static.....	266
Solutions When the Image is Fuzzy or Blurry	266
Solutions When the Image Brightness or Colors are Incorrect	267
Solutions to Sound Problems.....	267
Solutions When Image File Names are not Displayed Correctly in PC Free.....	268
Solving Projector or Remote Control Operation Problems	269
Solutions to Projector Power or Shut-Off Problems.....	269
Solutions to Problems with the Remote Control.....	269
Solutions to Password Problems.....	270
Solution When "The Battery that Saves Your Clock Settings is Running Low" Message Appears	270
Solving Interactive Features Problems.....	271
Solutions When "Error Occurred in the Easy Interactive Function" Message Appears.....	271
Solutions When the Interactive Pens Do Not Work.....	271
Solutions When Manual Calibration Does Not Work.....	272
Solutions When You Cannot Operate a Computer from the Projected Screen .	272

- Solutions When the Interactive Pen Position Is Not Accurate..... 272
- Solutions When the Interactive Pens Are Slow or Difficult to Use..... 273
- Solutions When the Interactive Touch Operation Does Not Work..... 273
- Solutions for Problems with Capturing, Printing, Saving, or Scanning..... 273
- Solutions When Inking Does Not Appear in Microsoft Office 274
- Solutions for Problems with a Shared Whiteboard 274
- Solutions When the Time Is Incorrect in Whiteboard Settings 274

Solving Network Problems 275

- Solutions When Wireless Authentication Fails 275
- Solutions When You Cannot Access the Projector Through the Web 275
- Solutions When Network Alert E-Mails are not Received..... 275
- Solutions When the Image Contains Static During Network Projection 275

Appendix 277

Optional Accessories and Replacement Parts..... 278

- Cables 278
- Mounts 278
- For Interactive Feature..... 278
- For Wireless Connection 278
- External Devices 279
- Replacement Parts..... 279

Screen Size and Projection Distance 280

Supported Monitor Display Resolutions 281

Projector Specifications..... 283

Connector Specifications..... 284

External Dimensions 285

USB Display System Requirements 287

Easy Interactive Driver System Requirements 288

List of Safety Symbols (corresponding to IEC60950-1 A2) 289

Glossary 291

Notices 293



- FCC Compliance Statement 293
- Indication of the manufacturer and the importer in accordance with requirements of EU directive..... 294
- Restriction of Use 294
- Operating System References..... 294
- Trademarks..... 294
- Copyright Notice 295
- Copyright Attribution..... 295

Notations Used in This Guide





Safety Symbols

The projector and its manuals use graphical symbols and labels to indicate content that tells you how to use the projector safely.

Read and carefully follow the instructions that are marked with these symbols and labels to avoid injury to persons or damage to property.

 Warning	This symbol indicates information that, if ignored, could possibly result in personal injury or even death.
 Caution	This symbol indicates information that, if ignored, could possibly result in personal injury or physical damage due to incorrect handling.

General Information Notations

Attention	This label indicates procedures that may result in damage or injury if sufficient care is not taken.
	This label indicates additional information that may be useful to know.
[Button name]	Indicates the name of the buttons on the remote control or the control panel. Example: [Esc] button
Menu/Setting name	Indicates projector menu and setting names. Example: Select the Image menu  Image > Advanced
	This label indicates links to the related pages.
	This label indicates a page where detailed information regarding a topic can be found.

Introduction to Your Projector

Refer to these sections to learn more about your projector's features and part names.

► **Related Links**

- "Projector Features" [p.10](#)
- "Projector Parts and Functions" [p.13](#)

This projector comes with this special features. Refer to these sections for more details.

» Related Links

- "Unique Interactive Functions" [p.10](#)
- "Quick and Easy Setup" [p.10](#)
- "Flexible Connectivity" [p.10](#)
- "Easy Operation from the Control Pad" [p.12](#)
- "Large-scale Presentation from the Whiteboard" [p.12](#)

Unique Interactive Functions

Easy annotation on the projected screen using the interactive pen or your finger.

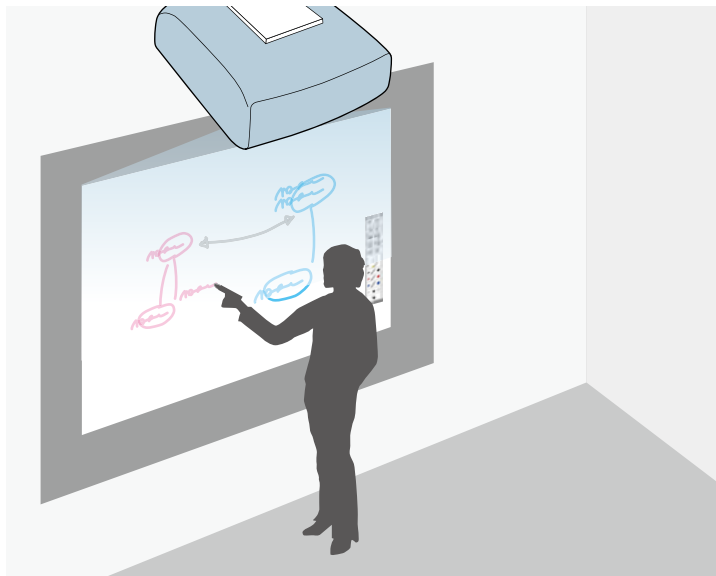

- Annotation with or without a computer.
- Annotation with two pens at the same time.

- Quick and easy toolbar to aid you in annotating the screen.
- Projector operations from the projected screen.
- Share your whiteboard with other devices, including tablets, smartphones, and other projectors with whiteboard sharing capabilities.
- Scan and display content from a connected scanner.
- Email, save, or print your content without a computer.
- Import content from a USB drive.
- Remote desktop connection to control a remote computer.
- Computer operations from the projected screen.
- Touch-based interactivity using your finger (EB-1450Ui).

Quick and Easy Setup

- Direct Power On feature to turn on the projector as soon as you plug it in.
- Auto Power On feature to turn on the projector when the projector detects an image signal from the port you specified as the **Auto Power On** source.
- Home screen feature to easily select an input source and useful functions.

» Related Links

- "Projector Setup Settings - Extended Menu" [p.213](#)
- "Turning On the Projector" [p.47](#)
- "Correcting the Image Shape with Quick Corner" [p.60](#)

Flexible Connectivity

This projector supports a wide variety of easy-to-use connectivity options as shown below.

» Related Links

- "Connect with Computers" [p.11](#)
- "Connect with Mobile Devices" [p.11](#)

Connect with Computers

- Connect with one USB cable to project images and output audio (USB Display).

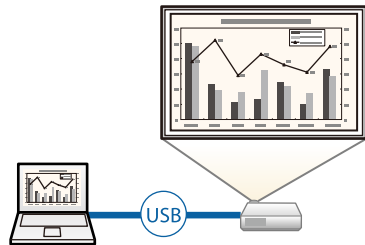

- EasyMP Multi PC Projection to project up to four images at the same time by splitting the projected screen. You can project images from computers on the network, or from smartphones or tablet devices on which Epson iProjection is installed.

See the *EasyMP Multi PC Projection Operation Guide* for details.

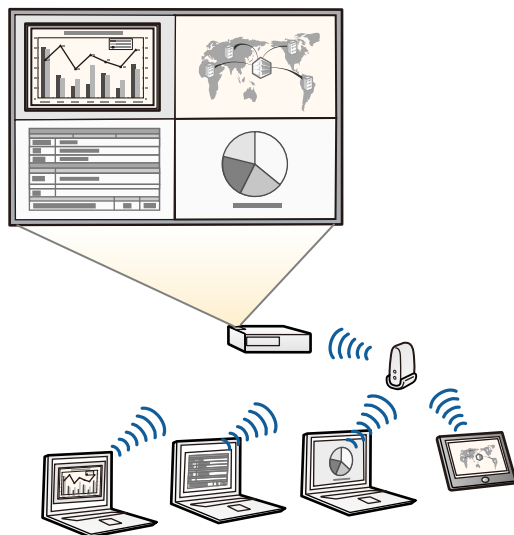

- When projecting images using a wireless LAN, you must install the Epson 802.11b/g/n wireless LAN module, and then set up your projector and computer for wireless projection.
- You can download the necessary software and manuals from the following Web site:
<http://www.epson.com/>

» Related Links

- "Optional Accessories and Replacement Parts" p.278
- "Connecting to a Computer" p.28
- "Using the Projector on a Network" p.172

Connect with Mobile Devices

- HDMI1/MHL port to connect an MHL cable to the mobile device and to the projector.

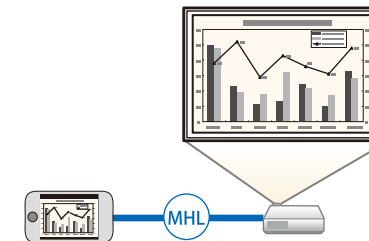

- Epson iProjection to connect your projector and mobile device wirelessly using the app available on App Store or Google play.



Any fees incurred when communicating with the App Store or Google play are the responsibility of the customer.

» Related Links

- "Connecting to Smartphones or Tablets" p.32

Easy Operation from the Control Pad

You can easily perform frequently used operations such as turning the power on/off and changing the source.

You can also connect various USB devices to multiple USB ports.

Large-scale Presentation from the Whiteboard

By connecting your projector to other projectors using the DVI-D Out port, you can easily project your whiteboard image live onto a large screen.

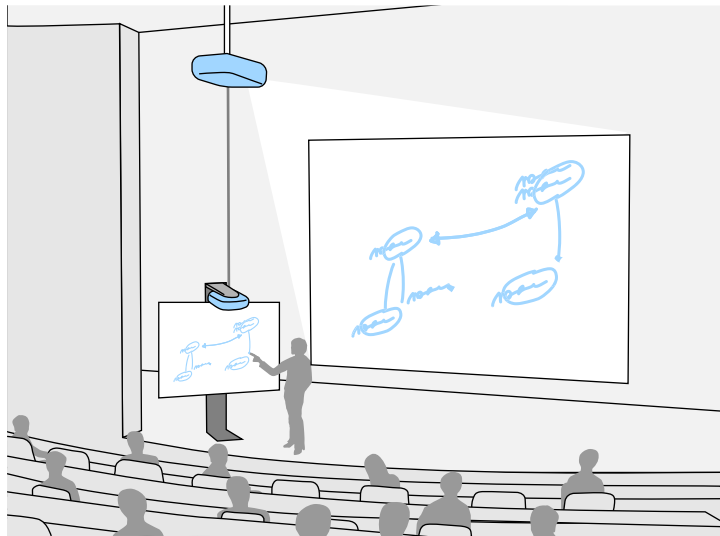

The following sections explain the projector parts and their functions.

► **Related Links**

- "Projector Parts - Front/Side" [p.13](#)
- "Projector Parts - Top/Side" [p.14](#)
- "Projector Parts - Interface" [p.15](#)
- "Projector Parts - Base" [p.17](#)
- "Projector Parts - Control Panel" [p.17](#)
- "Projector Parts - Remote Control" [p.18](#)
- "Projector Parts - Interactive Pens" [p.20](#)
- "Projector Parts - Pen Stand" [p.21](#)
- "Projector Parts - Control Pad" [p.21](#)
- "Projector Parts - Touch Unit" [p.22](#)

Projector Parts - Front/Side

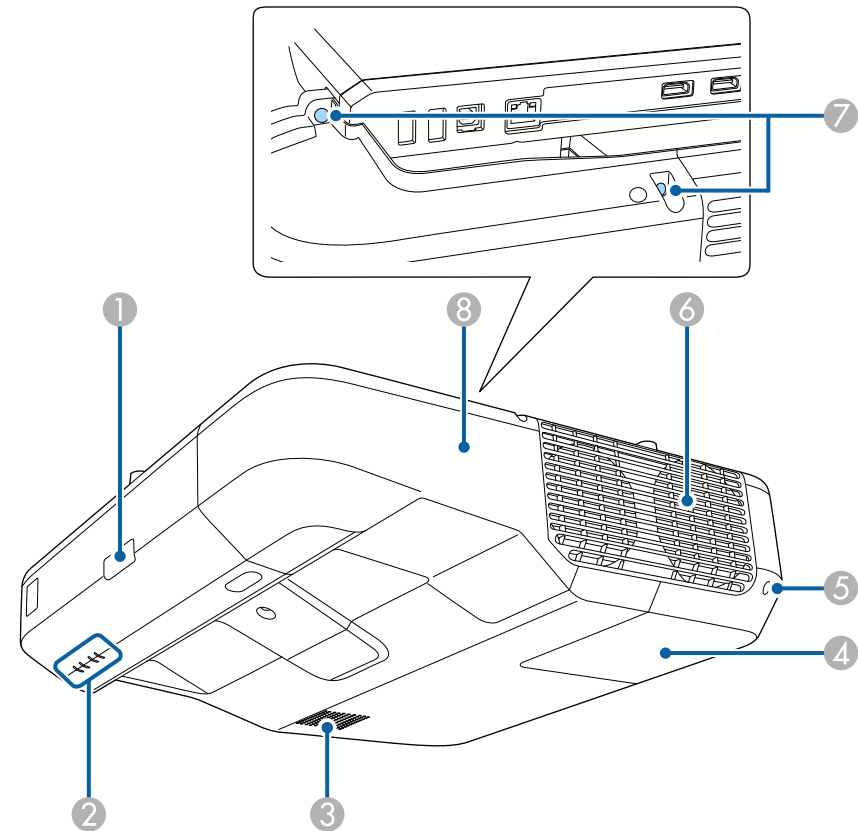

Name		Function
①	Remote receiver	Receives signals from the remote control.
②	Indicators	Indicates the projector's status.
③	Speaker	Outputs audio.
④	Lamp cover	Open to access the projector's lamp.
⑤	Lamp cover screw	Screw to fix the lamp cover in place.

Name	Function
6 Air exhaust vent	Exhaust vent for air used to cool the projector internally. ⚠ Warning Do not look into the vents. If the lamp explodes, gases may escape and small fragments of glass may be scattered which could cause an injury. Contact a doctor if any fragments of broken glass are inhaled or get into the eyes or mouth. ⚠ Caution While projecting, do not put your face or hands near the air exhaust vent, and do not place objects that may become warped or damaged by heat near the vent. Hot air from the air exhaust vent could cause burns, warping, or accidents to occur.
7 Cable cover screws	Screws to fix the cable cover in place.
8 Cable cover	Loosen the two screws and open the cover when connecting cables for external devices or installing the wireless LAN module.

Projector Parts - Top/Side

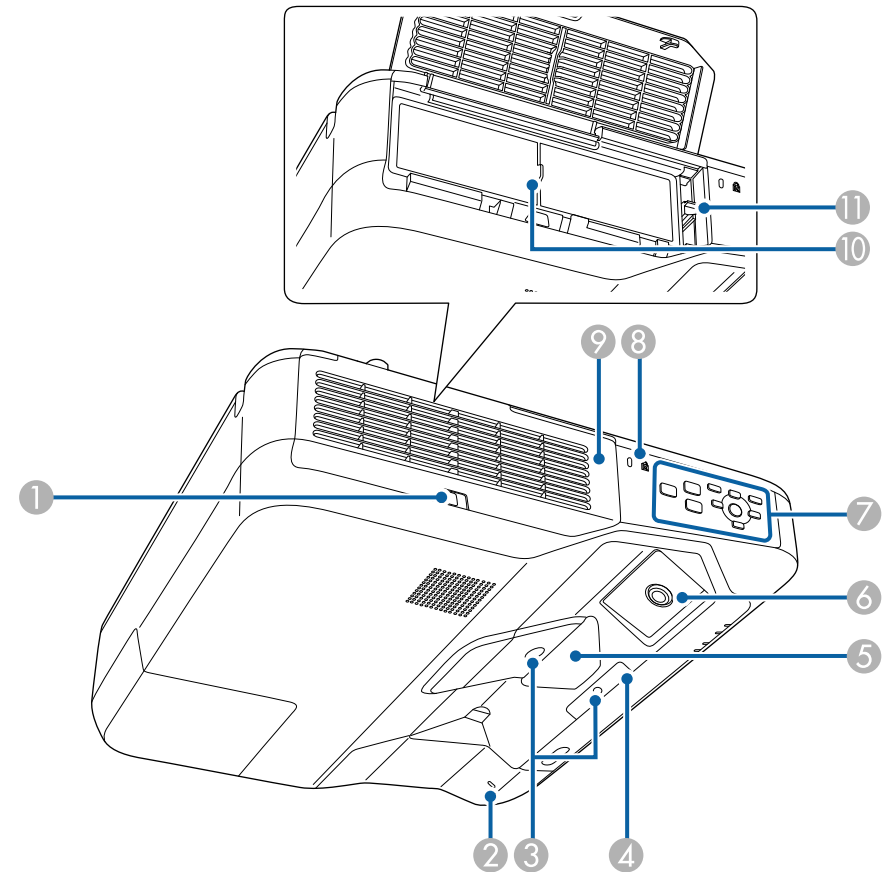

Name	Function
1 Filter cover latch	Opens the air filter cover.
2 Wireless LAN indicator	Indicates the access status of the supplied wireless LAN module.
3 Obstacle sensor	Detects obstacles that are interfering with the projection area.

Name	Function
4 Remote receiver	Receives signals from the remote control.
5 Projection window	Images are projected from here. <div style="border: 1px solid black; padding: 5px; margin-top: 10px;"> <p>⚠ Warning</p> <ul style="list-style-type: none"> Do not look into the projection window while projecting. Do not place any objects or put your hand near the projection window. It could cause burns, fire, or the object to warp because this area reaches a high temperature due to the concentrated projection light. </div>
6 Interactive pen receiver	Receives signals from the interactive pen.
7 Control panel	Operates the projector.
8 Security slot	The security slot is compatible with the Microsaver Security System manufactured by Kensington.
9 Air filter cover	Open to access the air filter or focus lever.
10 Air intake vent (air filter)	Takes in air to cool the projector internally.
11 Focus lever	Adjusts the image focus. Open the air filter cover to operate.

Projector Parts - Interface

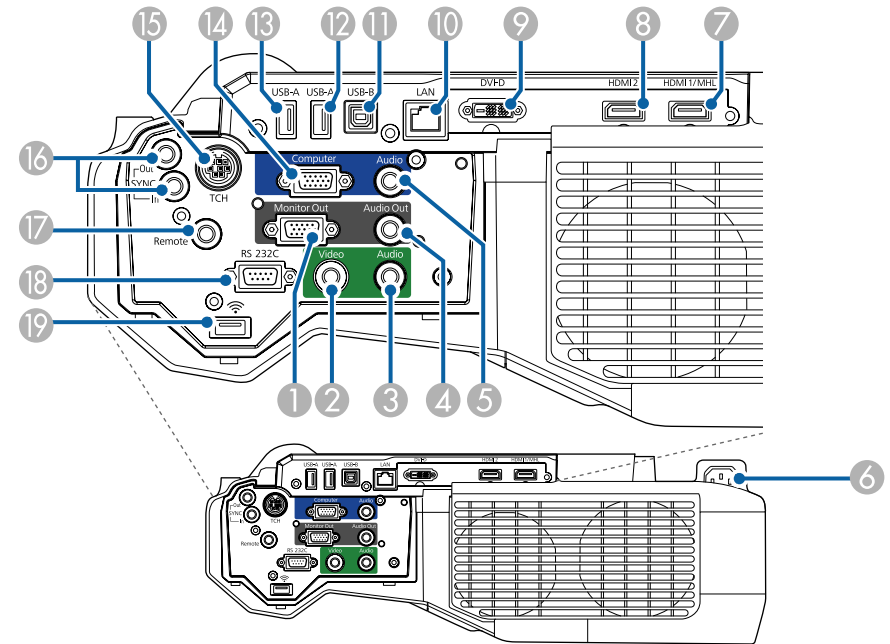

Name	Function
1 Monitor Out port	Outputs analog RGB signals input from the Computer port to an external monitor. You cannot output signals input from other ports or component video signals.
2 Video port	Inputs composite video signals from video sources.
3 Audio port	Inputs audio from equipment connected to the Video port. Inputs audio from other devices when projecting images from the device connected to the USB-A port. From now on, referred to as the Audio 2 port.
4 Audio Out port	Outputs audio from the current input source to an external speaker.

Name	Function
⑤ Audio port	Inputs audio from equipment connected to the Computer port. From now on, referred to as the Audio 1 port.
⑥ Power inlet	Connects the power cord to the projector.
⑦ HDMI1/MHL port	Inputs video signals from HDMI compatible video equipment and computers, or MHL (Mobile High-Definition) compatible mobile devices. This port is compatible with HDCP.
⑧ HDMI2 port	Inputs video signals from HDMI compatible video equipment and computers. This port is compatible with HDCP.
⑨ DVI-D Out port	Outputs video signals to an external monitor. This port is not compatible with HDCP.
⑩ LAN port	Connects a LAN cable to connect to a network.
⑪ USB-B port	Connects a USB cable to the computer to project computer images or to use the Wireless Mouse function. Connects the projector to a computer via the supplied USB cable to use the interactive pen as a mouse. Connects a USB cable to the control pad when connecting a computer to the control pad.
⑫ USB-A port	Connects a USB memory device or a digital camera and projects movies or images using PC Free. Select USB1 as the image source when you connect a USB device to this port to use the projector's PC Free features. Connects the optional document camera. Select USB2 as the image source when you connect the document camera to this port. Connects a USB cable to the control pad when connecting a USB storage device, printer, or USB keyboard to the control pad.

Name	Function
⑬ USB-A port	Connects a USB memory device or a digital camera and projects movies or images using PC Free. Select USB1 as the image source when you connect a USB device to this port to use the projector's PC Free features. Connects the optional document camera. Select USB2 as the image source when you connect the document camera to this port. Connects a USB cable to the control pad when connecting a USB storage device, printer, or USB keyboard to the control pad.
⑭ Computer port	Inputs image signals from a computer and component video signals from other video sources.
⑮ TCH port (EB-1450Ui)	Connects the supplied Touch Unit connection cable to the Touch Unit.
⑯ SYNC IN/OUT port	When using the interactive features in the same room as multiple versions of the same projector, you need to connect the optional remote control cable set to the projectors. When the cable set is connected, the interactive pen operates stably.
⑰ Remote port	Connects to the control pad with the remote control cable set.
⑱ RS-232C port	Connects an RS-232C cable to control the projector from a computer. (This port is for control use and should not normally be used.)
⑲ Wireless LAN module slot	Install the supplied wireless LAN module.

Projector Parts - Base

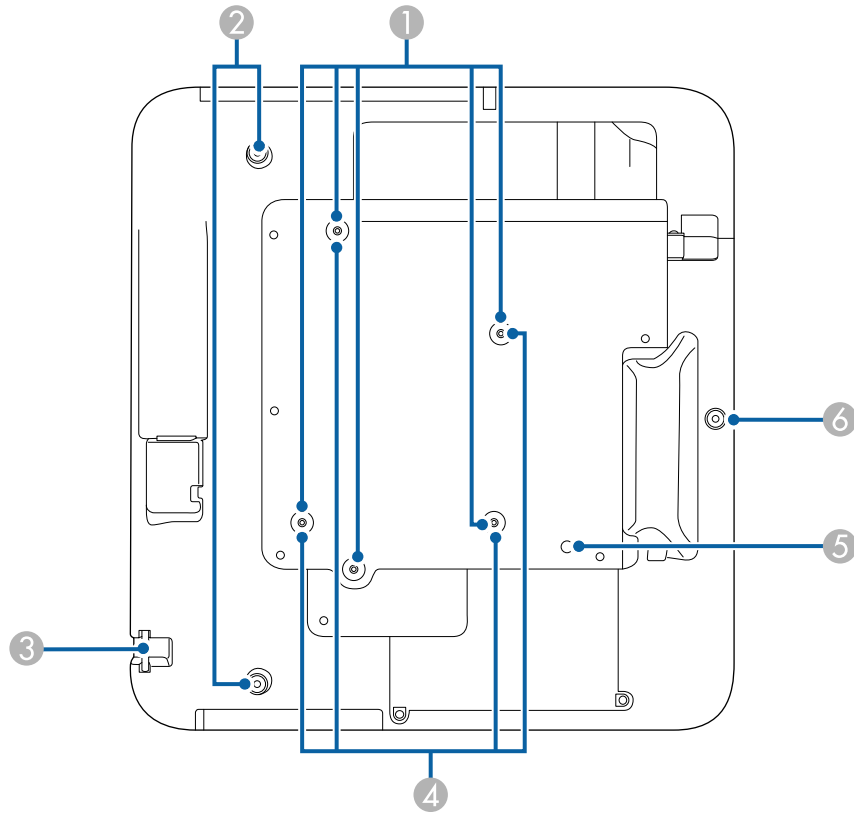

Name	Function
③ Security cable attachment point	Pass a commercially available wire lock through here and lock it in place. Do not pass drop-prevention wires through here when mounting the projector on a wall or suspending it from a ceiling.
④ Wall mount fixing points (four points)	Attach the supplied or optional setting plate when mounting on a wall.
⑤ Illumination sensor	Detects the brightness of the surroundings, and automatically adjusts the brightness of the screen. Set Power Consumption to Auto in the projector's ECO menu.
⑥ Front foot fixing point	Attach the foot with a spacer when using the projector on a surface such as a desk. (Only models with feet supplied)

Name	Function
① Ceiling mount fixing points (five points)	Attach the optional ceiling mount here when suspending the projector from a ceiling.
② Rear foot fixing points (two points)	Attach the feet when using the projector on a surface such as a desk. (Only models with feet supplied)

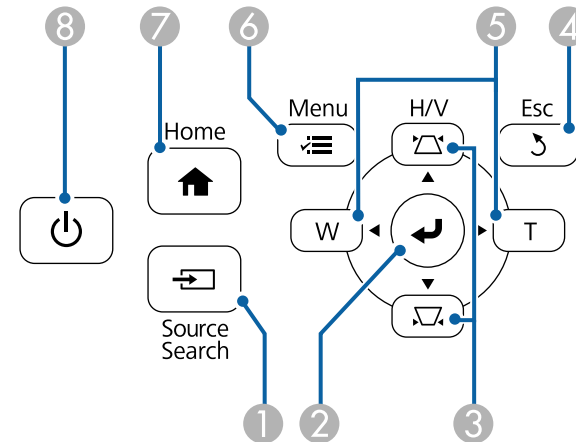

Projector Parts - Control Panel

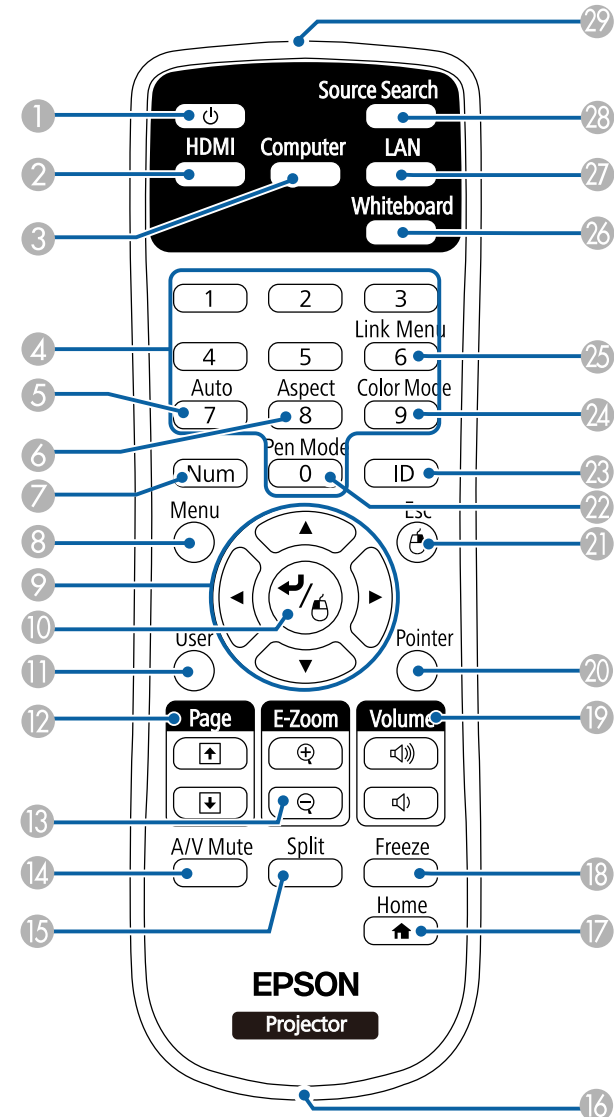

Name	Function
① [Source Search] button	Changes to the next input source.
② [Enter] button [↵]	Enters the current selection and moves to the next level while displaying the projector's menu or help. Optimizes Tracking , Sync. , and Position in the projector's Signal menu while projecting an analog RGB signal from the Computer port. From now on, referred to as the [Enter] button.
③ Keystone adjustment buttons and arrow buttons	Displays the Keystone screen allowing you to correct keystone distortion. Selects menu items while displaying the projector's menu or help.
④ [Esc] button	Stops the current function. Moves back to the previous menu level while displaying the projector's menu.
⑤ Wide/Tele buttons and arrow buttons	W : Enlarges the size of the projected image. T : Reduces the size of the projected image. Corrects keystone distortion in the horizontal direction when the Keystone screen is displayed. Selects menu items while displaying the projector's menu or help.
⑥ [Menu] button	Displays and closes the projector's menu.
⑦ [Home] button	Displays and closes the Home screen.
⑧ Power button [⏻]	Turns the projector on or off. From now on, referred to as the power button.

Projector Parts - Remote Control



Name	Function
① Power button []	Turns the projector on or off. From now on, referred to as the power button.
② [HDMI] button	Switches the image source between the HDMI ports.
③ [Computer] button	Selects the Computer port as the image source.
④ Numeric buttons	Enters numbers in the projector's menu while holding down the [Num] button.
⑤ [Auto] button	Optimizes Tracking , Sync. , and Position in the projector's Signal menu while projecting an analog RGB signal from the Computer port.
⑥ [Aspect] button	Changes the aspect mode.
⑦ [Num] button	Hold down this button to enter numbers using the numeric buttons.
⑧ [Menu] button	Displays and closes the projector's menu.
⑨ Arrow buttons	Selects menu items while displaying the projector's menu or help.
⑩ [Enter] button []	Enters the current selection and moves to the next level while displaying the projector's menu or help. Acts as a mouse's left button when using the Wireless Mouse function. From now on, referred to as the [Enter] button.
⑪ [User] button	Performs settings assigned in the User Button setting in the projector's Settings menu.
⑫ [Page] up/down buttons	Controls page up and down on your computer when you connect a projector and computer using a USB cable or over a network. Displays the previous or next screen while using the PC Free feature.
⑬ [E-Zoom] +/- buttons	Zooms in or zooms out the image area.
⑭ [A/V Mute] button	Turns the video and audio on or off temporarily.
⑮ [Split] button	Projects two images from different image sources simultaneously by splitting the projected screen.

Name	Function
⑯ Strap attachment point	Allows you to attach a commercially available strap to the remote control.
⑰ [Home] button	Displays and closes the Home screen.
⑱ [Freeze] button	Pauses or resumes images.
⑲ [Volume] up/down buttons	Adjusts the speaker volume.
⑳ [Pointer] button	Displays the on-screen pointer.
㉑ [Esc] button	Stops the current function. Moves back to the previous menu level while displaying the projector's menu. Acts as a mouse's right button when using the Wireless Mouse function.
㉒ [Pen Mode] button	Changes between operating the computer or drawing using the interactive pen. (This button cannot be used in whiteboard mode.)
㉓ [ID] button	Hold down this button and press the numeric buttons to select the ID for the projector you want to operate using the remote control.
㉔ [Color Mode] button	Changes the color mode.
㉕ [Link Menu] button	Displays the settings menu for the device linked to the projector's HDMI ports.
㉖ [Whiteboard] button	Turns the projector on (if necessary) and displays whiteboard mode. Switches to the previous input source during whiteboard mode.
㉗ [LAN] button	Switches the image source between the network connected devices.
㉘ [Source Search] button	Changes to the next input source.
㉙ Remote control light emitting area	Outputs remote control signals.

Projector Parts - Interactive Pens

Hold the pen to turn it on automatically. Pens turn off automatically after 15 seconds when you put them down.

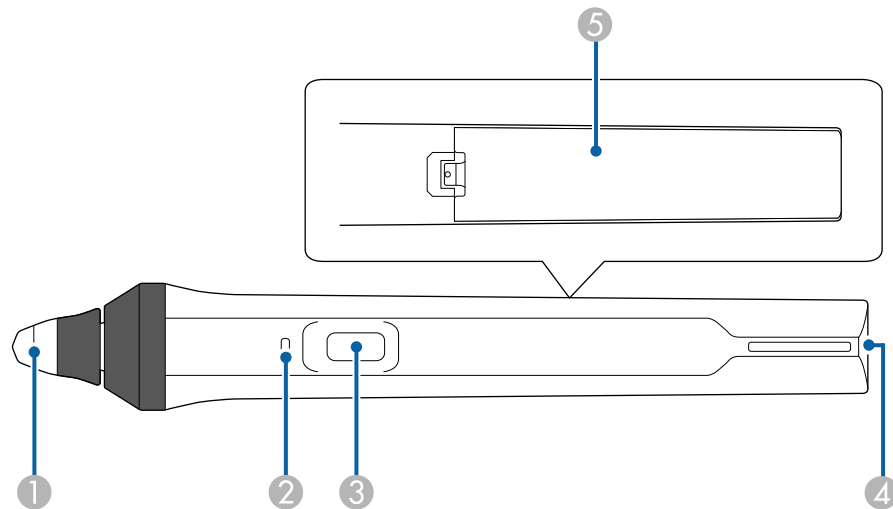

Name	Function
3 Button	<p>When Pen Button Function is set to Eraser in the projector's Extended menu, press the button to switch the tip function between pen and eraser while drawing.</p> <p>When Pen Button Function is set to Open Drawing Toolbar, press the button to display the toolbar near the pen tip.</p> <p>When Pen Button Function is set to Clear Screen, press the button to erase all the contents drawn on the projected screen.</p> <p>Extended > Easy Interactive Function > General > Advanced > Pen Button Function</p> <p>Press the button to perform a right-click operation while using the pen as a mouse.</p>
4 Strap attachment point	Allows you to attach a commercially available strap.
5 Battery cover	Open this cover when replacing the battery.

► Related Links

- "Replacing the Interactive Pen Tip" [p.256](#)

Name	Function
1 Pen tip	<p>Replaceable soft pen tip.</p> <p>If the soft tip is hard to use on a textured surface, replace it with the hard tip.</p>
2 Battery indicator	<p>Press the button on the side of the pen to indicate the remaining battery power.</p> <ul style="list-style-type: none"> • When the battery is charged, the indicator turns blue until you release the button. • When the battery is running low, the indicator flashes blue until you release the button. • Does not light when the battery is exhausted. Change the battery.

Projector Parts - Pen Stand

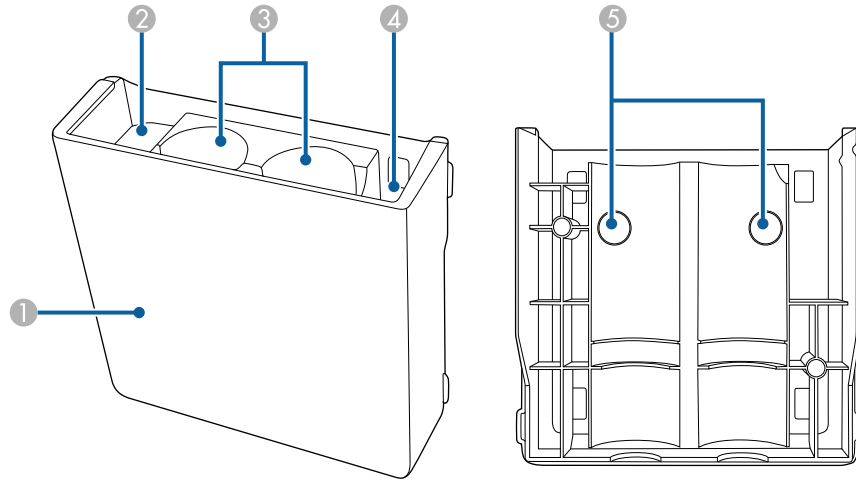

Name	Function
① Front cover	Open to install the pen stand.
② Pen tip storage space	Keep the pen tips here.
③ Pen storage space	Keep the pens here.
④ Battery storage space	Keep the AA batteries here.
⑤ Screw holes (for installation)	The screw holes for securing the pen stand.

Projector Parts - Control Pad

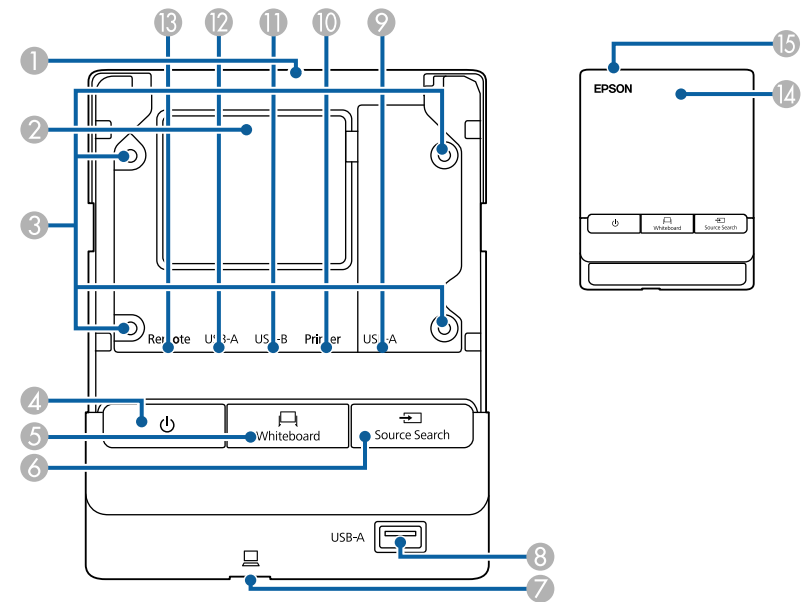

Name	Function
① Cable path (upper)	Open the cover to route cables through here.
② Cable path	Route cables through here.
③ Screw holes (for installation)	The screw holes for securing the control pad.
④ Power button [⏻]	Turns the projector on or off. From now on, referred to as the power button.
⑤ [Whiteboard] button	Turns the projector on (if necessary) and displays whiteboard mode. Switches to the previous input source during whiteboard mode.
⑥ [Source Search] button	Changes to the next input source.

Name	Function
⑦ USB-B port (for connecting a computer)	Connects a USB cable to the computer to project computer images or to use the interactive pen as a mouse.
⑧ USB-A port (for connecting USB storage)	Connects a USB storage device.
⑨ USB-A port (for connecting a keyboard)	Connects an external USB keyboard.
⑩ USB-A port (for connecting a printer)	Connects a USB cable to the printer.
⑪ USB-B port (for connecting a projector)	Connects a USB cable to the projector when connecting a USB storage device, printer, or USB keyboard to the control pad.
⑫ USB-A port (for connecting a projector)	Connects a USB cable to the projector when connecting a computer to the control pad.
⑬ Remote port	Connects to the projector with the cable supplied with the control pad to power the control pad.
⑭ Front cover	Open to connect cables.
⑮ Cable cover	Open this cover when cables are wired along a wall.

 Stick the supplied port protection stickers on the ports that are not being used.

Projector Parts - Touch Unit

The Touch Unit comes with the EB-1450Ui only.

Front

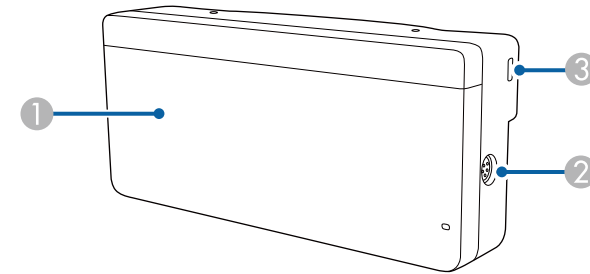

When the dial cover is not attached

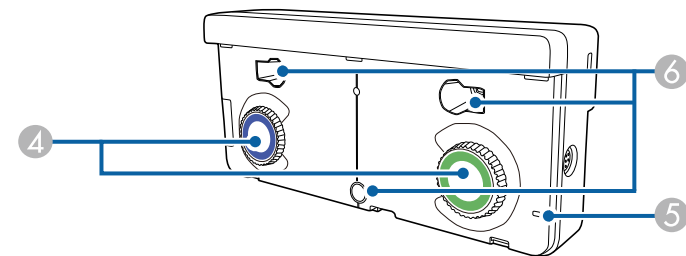

Name	Function
① Dial cover	Remove to use the adjustment dials.
② TCH port	Connects the projector to the Touch Unit with the Touch Unit connection cable.
③ Security slot	The security slot is compatible with the Microsaver Security System manufactured by Kensington.
④ Adjustment dials	Perform angle adjustments.
⑤ Indicator	Lit when the Touch Unit is turned on.
⑥ Screw holes (for installation)	The screw holes for securing the Touch Unit.

Rear

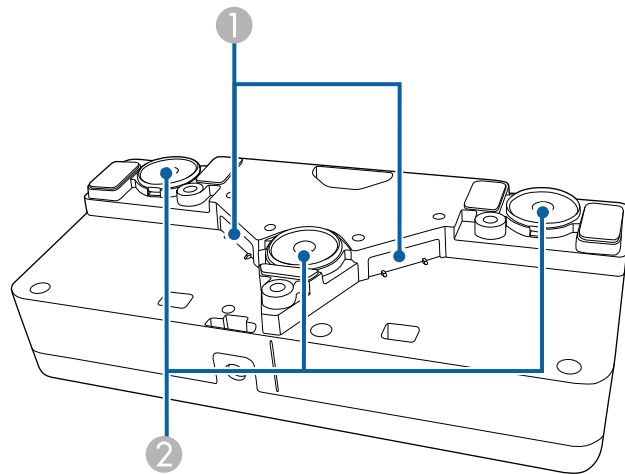

Attention

- Do not connect the Touch Unit to any devices except for EB-1450Ui. The device could malfunction, or laser light could leak beyond the limit.
- Make sure you use the supplied Touch Unit connection cable. Operations are not possible with a commercially available cable.
- When disposing of the Touch Unit, do not disassemble it. Dispose according to your local or national laws and regulations.



See the *Installation Guide* for the Touch Unit installation methods and angle adjustment methods.

Name	Function
① Laser diffusion ports	Diffuse laser light to detect the position of fingers.
② Installation magnets	Magnets used for installation.

⚠ Warning

Do not use the Touch Unit near medical equipment such as pace makers. Furthermore, when using the Touch Unit, make sure there is no medical equipment such as pace makers, in the surrounding area. Electromagnetic interference may cause medical equipment to malfunction.

⚠ Caution

- Do not use the Touch Unit near magnetic storage media such as magnetic cards, or precision electronic devices such as computers, digital watches, or cell phones. Data could be corrupted or a malfunction could occur.
- When installing the Touch Unit on a magnetic surface, be careful not to trap your fingers or any other part of your body between the magnet and the installation surface.

Setting Up the Projector

Follow the instructions in these sections to set up your projector.

► Related Links

- "Projector Placement" [p.25](#)
- "Projector Connections" [p.28](#)
- "Installing Batteries in the Remote Control" [p.43](#)
- "Installing Batteries in the Pens" [p.44](#)
- "Remote Control Operation" [p.45](#)

You can install the projector on a wall, or place it on a table to project images.

You need the optional mounts when suspending the projector from a ceiling, installing it on a wall, or placing it vertically on a table.

Note the following points when selecting a projector location:

- Place the projector on a sturdy, level surface or install it using a compatible mount.
- Leave plenty of space around and under the projector for ventilation, and do not place it on top of or next to anything that could block the vents.
- Position the projector within reach of a grounded electrical outlet or extension cord.
- Place the projector parallel to the screen.



If you cannot install the projector parallel to the screen, correct keystone distortion using the projector controls.

⚠ Warning

- A special method of installation is required when suspending the projector from a wall or ceiling. If you do not install the projector correctly, it could fall and cause damage or injury.
- Do not use adhesives on the wall mount plate fixing points or the ceiling mount fixing points to prevent the screws from loosening, or use lubricants, oils, or similar substances on the projector; the projector case may crack causing it to fall from its mount. This could cause serious injury to anyone under the mount and could damage the projector.
- Do not cover the projector's air intake or air exhaust vents. If the vents are covered, the internal temperature could rise and cause a fire.
- Do not install the projector on an unstable surface or in a location beyond the weight specifications of the projector. Otherwise, it could fall or topple causing an accident and injury.
- When installing the projector in a high position, take measures to prevent falling by using wires to ensure safety in an emergency, such as an earthquake, and to prevent accidents. If it is not installed correctly, it could fall causing an accident and injury.

Attention

- If you are using the projector at altitudes above 1500 m, set the **High Altitude Mode** setting to **On** in the projector's **Extended** menu to ensure the projector's internal temperature is regulated properly.
 - ☛ **Extended > Operation > High Altitude Mode**
- Try not to setup the projector in locations subject to high humidity and dust, or in locations subject to smoke from fires or tobacco smoke.

» Related Links

- "Projector Setup and Installation Options" [p.25](#)
- "Settings when Using the Interactive Features" [p.26](#)
- "Image Shape" [p.59](#)
- "Optional Accessories and Replacement Parts" [p.278](#)
- "Projector Setup Settings - Extended Menu" [p.213](#)

Projector Setup and Installation Options

You can set up or install your projector in the following ways:

Front/Rear

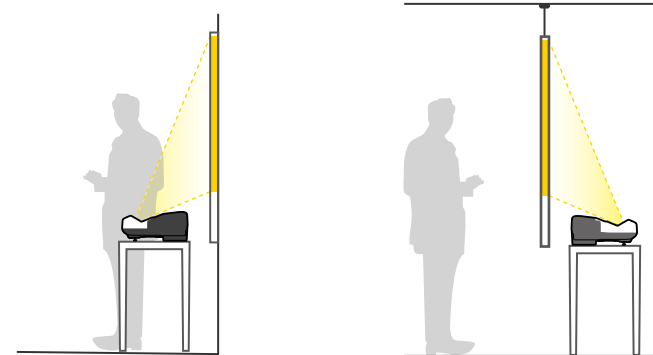

Attach the feet (if supplied) when using the projector on a surface such as a desk.

Front Upside Down/Rear Upside Down

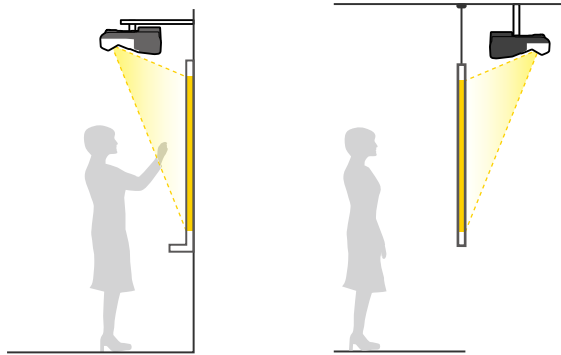

Front Upside Down/Rear Upside Down (Vertically)

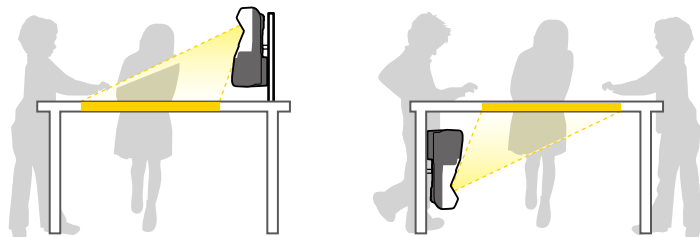

Make sure you select the correct **Projection** option in the projector's **Extended** menu according to the installation method being used.



- The default **Projection** setting is **Front/Upside Down**.
- You can change the **Projection** setting as follows by pressing down the [A/V Mute] button on the remote control for about five seconds.
 - Switch **Front** to/from **Front/Upside Down**
 - Switch **Rear** to/from **Rear/Upside Down**

Settings when Using the Interactive Features

When using the interactive features, project from in front of the screen.
Set **Projection** to **Front/Upside Down** or **Front**.

Attention

The interactive features are operated using infrared communication. Note the following points when installing the projector.

- Make sure there is no strong light or sunlight shining on the interactive pen receiver, the projection screen, the projector itself, or the rear of the projector.
- Do not install the projector where it could be subjected to direct sunlight through a window. This could cause the interactive features to malfunction.
- Install the projector so that the interactive pen receiver is not too close to fluorescent lights. If the surrounding area is too bright, the interactive features may not operate correctly.
- If there is any dust stuck to the interactive pen receiver, it could interfere with infrared communication and the interactive features may not operate correctly. Clean the receiver if it is dirty.
- Do not put paint or any stickers on the cover of the interactive pen receiver.
- When using the interactive features, do not use an infrared remote control or microphone in the same room. The interactive pen could malfunction.
- Do not use devices that generate powerful noise, such as rotary devices or transformers, near the projector, as the interactive features may not operate correctly.

» Related Links

- "Projection Modes" [p.54](#)



- We recommend using a smooth, board type screen without any unevenness. If the projection screen is uneven, there may be distortions in the projected image.
- Distortions may occur in the projected image depending on the material of the screen and the installation method.
- When using the interactive features, install the projector so that the projected screen is a rectangle without any distortion.
- When using the interactive features in the same room as multiple projectors, interactive pen operations may become unstable. In this case, connect the optional remote control cable set to the projectors, and change **Sync of Projectors** to **Wired** from the projector's **Extended** menu.
 - ☛ **Extended > Easy Interactive Function > General > Advanced > Sync of Projectors**

» Related Links

- "Settings when Using the Touch Unit" [p.27](#)

Settings when Using the Touch Unit

When using the Touch Unit, install the projector using one of the following methods (EB-1450Ui). The Touch Unit cannot be used if another installation method is used.

- Mount the projector on a wall or suspend it from a ceiling and project images from in front of the screen (the setting plate or ceiling mount is required).
- Install vertically on a desk and project from the front of the desk (the interactive table mount is required).

» Related Links

- "Optional Accessories and Replacement Parts" [p.278](#)

You can connect the projector to a variety of computer, video, and audio sources to display presentations, movies, or other images, with or without sound.

Attention

Check the shape and orientation of the connectors on any cable you plan to connect. Do not force a connector into a port if it does not fit. The device or your projector could be damaged or could malfunction.



See the *Quick Start Guide* for a list of cables supplied with your projector. Purchase optional or commercially available cables when necessary.

- Connect a computer that has a USB port, standard video output (monitor) port, or HDMI port.
- For video projection, connect devices such as DVD players, gaming consoles, digital cameras, and smartphones with compatible video output ports.
- If your presentation or video includes sound, you can connect audio input cables.
- For slide shows or presentations without a computer, you can connect USB devices (such as a flash drive or camera) or the optional Epson document camera.

» Related Links

- "Connecting to a Computer" [p.28](#)
- "Connecting to Smartphones or Tablets" [p.32](#)
- "Connecting to Video Sources" [p.32](#)
- "Connecting to External USB Devices" [p.35](#)
- "Connecting a Printer to the Control Pad" [p.37](#)
- "Connecting to a Document Camera" [p.37](#)
- "Connecting an External USB Keyboard to the Control Pad" [p.37](#)
- "Connecting to External Output Devices" [p.38](#)
- "Connecting Multiple Projectors of the Same Model" [p.40](#)
- "Optional Accessories and Replacement Parts" [p.278](#)

Connecting to a Computer

Follow the instructions in these sections to connect a computer to the projector.

» Related Links

- "Connecting to a Computer for VGA Video and Audio" [p.28](#)
- "Connecting to a Computer for USB Video and Audio" [p.29](#)
- "Connecting to a Computer for HDMI Video and Audio" [p.30](#)
- "Connecting a Computer to the Control Pad" [p.31](#)

Connecting to a Computer for VGA Video and Audio

You can connect the projector to your computer using a VGA computer cable.

You can play sound through the projector's speaker system by connecting a commercially available 3.5 mm stereo mini-jack audio cable.



- To connect a Mac that does not have a VGA video port, you need an adapter that allows you to connect to the projector's VGA video port.
- You can also set the port used for audio input from the projector's menu.
 - **Extended > A/V Settings > Audio Output**
- Make sure the audio cable is labeled "No resistance".

- 1** Connect the VGA computer cable to your computer's monitor port.

- 2 Connect the other end to a Computer port on the projector.

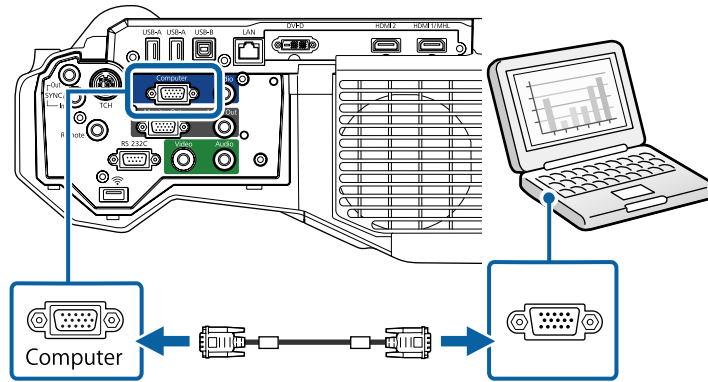

- 3 Tighten the screws on the VGA connector.
- 4 Connect the audio cable to your laptop's headphone or audio-out jack, or your desktop's speaker or audio-out port.
- 5 Connect the other end to the projector's Audio 1 port.

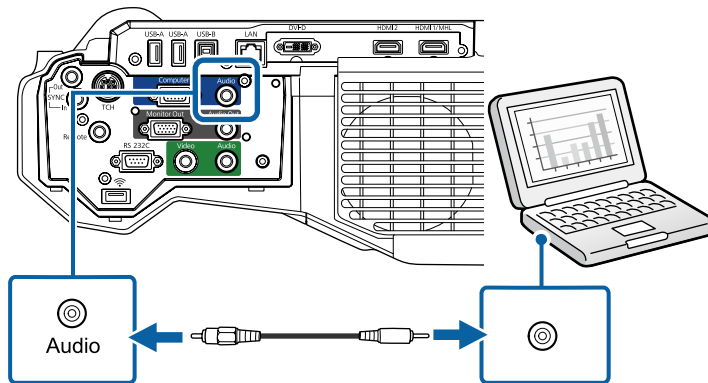

Connecting to a Computer for USB Video and Audio

If your computer meets the system requirements, you can send video and audio output to the projector through the computer's USB port. This function is called USB Display. Connect the projector to your computer using a USB cable.



- If you use a USB hub, the connection may not operate correctly. Connect the USB cable directly to the projector.
- To use the USB Display function, select **USB Display/Easy Interactive Function** or **Wireless Mouse/USB Display** as the **USB Type B** setting in the projector's **Extended** menu.

- 1 Connect the cable to your projector's USB-B port.

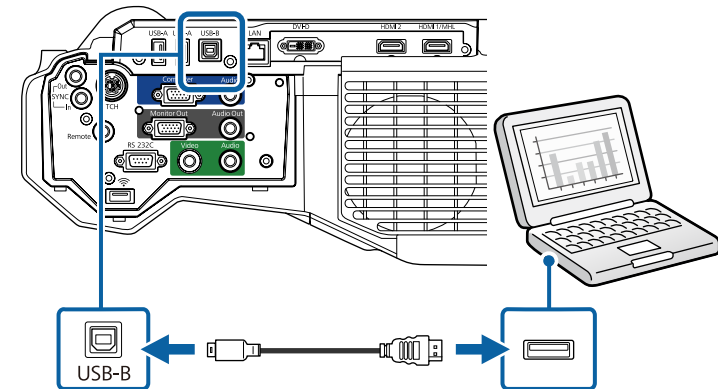

- 2 Connect the other end to any available USB port on your computer.
- 3 Turn on the projector and your computer.
- 4 Do one of the following to install the Epson USB Display software:



You only need to install this software the first time you connect the projector to the computer.

- Windows: Select **Run EMP_UDSE.EXE** in the dialog box that is displayed to install the Epson USB Display software.
- OS X: The Epson USB Display setup folder is displayed on your screen. Select **USB Display Installer** and follow the on-screen instructions to install the Epson USB Display software. If the USB Display **Setup** folder is not displayed automatically, double-click **EPSON_PJ_UD > USB Display Installer**.

5 Follow any on-screen instructions.

Do not disconnect the USB cable or turn off the projector until the projector displays an image.

The projector displays the image from your computer's desktop and outputs sound if your presentation contains audio.



- If the projector does not project any images, do one of the following:
 - Windows: Click **All Programs > EPSON Projector > Epson USB Display > Epson USB Display Ver.x.xx**.
 - OS X: Double-click the **USB Display** icon in the **Application** folder.
- When you finish projection, do one of the following:
 - Windows: Disconnect the USB cable. You do not need to operate **Safely Remove Hardware**.
 - OS X: Select **Disconnect** from the **USB Display** icon menu on the menu bar or **Dock**, and then disconnect the USB cable.

» Related Links

- "USB Display System Requirements" [p.287](#)

Connecting to a Computer for HDMI Video and Audio

If your computer has an HDMI port, you can connect it to the projector using an HDMI cable and send the computer's audio with the projected image.



To connect a Mac that does not have an HDMI port, you need an adapter that allows you to connect to the projector's HDMI port. Contact Apple for compatible adapter options. Older Mac computers (2009 and earlier) may not support audio through the HDMI port.

- 1 Connect the HDMI cable to your computer's HDMI output port.
- 2 Connect the other end to the projector's HDMI port.

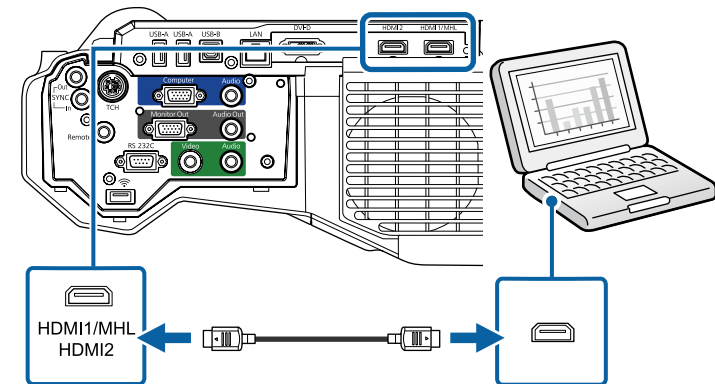

If you have problems hearing audio through the HDMI connection, connect one end of a commercially available 3.5 mm stereo mini-jack audio cable to the projector's Audio port and the other end to your computer's audio out port. Select the audio input port you connected to in the projector's **Extended** menu.

- **Extended > A/V Settings > HDMI1 Audio Output**
- **Extended > A/V Settings > HDMI2 Audio Output**

» Related Links

- "Projector Setup Settings - Extended Menu" [p.213](#)

Connecting a Computer to the Control Pad

If your computer meets the system requirements, you can send video and audio output to the projector through the control pad's USB-B port. This function is called USB Display. Connect the projector and your computer to the control pad using USB cables.



- If you use a USB hub, the connection may not operate correctly. Connect the USB cable directly to the control pad.
- You can also connect a computer directly to the projector's USB-B port.
- To use the USB Display function, select **USB Display/Easy Interactive Function** or **Wireless Mouse/USB Display** as the **USB Type B** setting in the projector's **Extended** menu.

- 1** Connect the projector to the control pad.
- 2** Turn on the projector and your computer.
- 3** Connect another USB cable to the USB-B port on the bottom of the control pad and any available USB port on your computer.

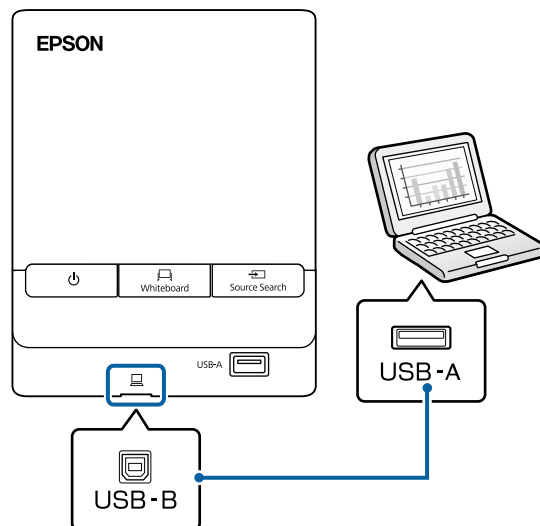

- 4** Do one of the following to install the Epson USB Display software:



You only need to install this software the first time you connect the projector to the computer.

- Windows: Select **Run EMP_UDSE.EXE** in the dialog box that is displayed to install the Epson USB Display software.
- OS X: The Epson USB Display setup folder is displayed on your screen. Select **USB Display Installer** and follow the on-screen instructions to install the Epson USB Display software. If the USB Display **Setup** folder is not displayed automatically, double-click **EPSON_PJ_UD > USB Display Installer**.

- 5** Follow any on-screen instructions.

Do not disconnect the USB cable or turn off the projector until the projector displays an image.

The projector displays the image from your computer's desktop and outputs sound if your presentation contains audio.



- If the projector does not project any images, do one of the following:
 - Windows: Click **All Programs > EPSON Projector > Epson USB Display > Epson USB Display Ver.x.xx**.
 - OS X: Double-click the **USB Display** icon in the **Application** folder.
- When you finish projection, do one of the following:
 - Windows: Disconnect the USB cable. You do not need to operate **Safely Remove Hardware**.
 - OS X: Select **Disconnect** from the **USB Display** icon menu on the menu bar or **Dock**, and then disconnect the USB cable.

Connecting to Smartphones or Tablets

You can connect the projector to smartphones and tablets using a MHL cable and send the audio with the projected image.



- You may not be able to project correctly, depending on the model and settings of the smartphone or tablet.
- You may not be able to connect an MHL cable to all devices. Contact the manufacturer of your smartphone or tablet device to check if your device supports MHL.

- 1** Connect the MHL cable to your device's Micro-USB port.
- 2** Connect the other end to the projector's HDMI1/MHL port.

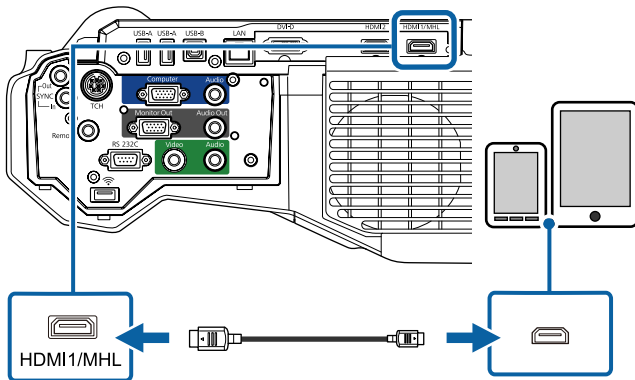

Attention

If you connect an MHL cable that does not support the MHL standards, the smartphone or tablet device may become hot, or leakage or explosion may happen.

The connected smartphone or tablet begins charging when images are projected. If you connect using a MHL-HDMI conversion adapter,

charging the smartphone or tablet device may not work or you may not be able to perform operations using the projector's remote control.



- Charging may not work when using a lot of power, such as when playing a movie.
- Charging does not work when the projector is in standby mode or the battery in a smartphone or tablet is depleted.



If images are not projected correctly, disconnect and then reconnect the MHL cable.

Connecting to Video Sources

Follow the instructions in these sections to connect video devices to the projector.



- If the port on the device you connect has an unusual shape, use the cable supplied with the device or an optional cable to connect to the projector.
- The cable differs depending on the output signal from the connected video devices.
- Some video devices are capable of outputting different types of signals. See your video device manual to confirm what type of signals can be output.

» Related Links

- "Connecting to an HDMI Video Source" [p.33](#)
- "Connecting to a Component-to-VGA Video Source" [p.33](#)
- "Connecting to a Composite Video Source" [p.34](#)

Connecting to an HDMI Video Source

If your video source has an HDMI port, you can connect it to the projector using an HDMI cable and send the image source's audio with the projected image.

Attention

Do not turn on the video source before connecting it to the projector. Doing so could damage the projector.

- 1 Connect the HDMI cable to your video source's HDMI output port.
- 2 Connect the other end to the projector's HDMI port.

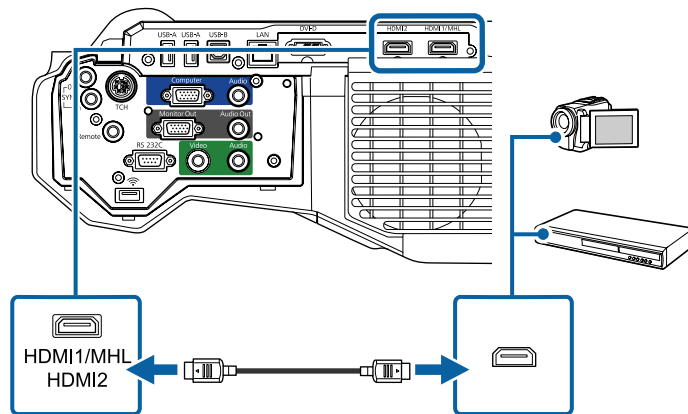

If you have problems hearing audio through the HDMI connection, connect one end of a commercially available 3.5 mm stereo mini-jack audio cable to the projector's Audio port and the other end to your video source's audio out port. Select the audio input port you connected to in the projector's **Extended** menu.

- Extended > A/V Settings > HDMI1 Audio Output
- Extended > A/V Settings > HDMI2 Audio Output

» Related Links

- "Projector Setup Settings - Extended Menu" [p.213](#)

Connecting to a Component-to-VGA Video Source

If your video source has component video ports, you can connect it to the projector using a component-to-VGA video cable. Depending on your component ports, you may need to use an adapter cable along with a component video cable.

You can play sound through the projector's speaker system by connecting a stereo mini-jack audio cable.



- You can also set the port used for audio input in the projector's **Extended** menu.
 - Extended > A/V Settings > Audio Output
- Make sure the audio cable is labeled "No resistance".

1

Connect the component connectors to your video source's color-coded component video output ports.



The ports usually labeled Y, Pb, Pr or Y, Cb, Cr. If you are using an adapter, connect these connectors to your component video cable.

2 Connect the VGA connector to a Computer port on the projector.

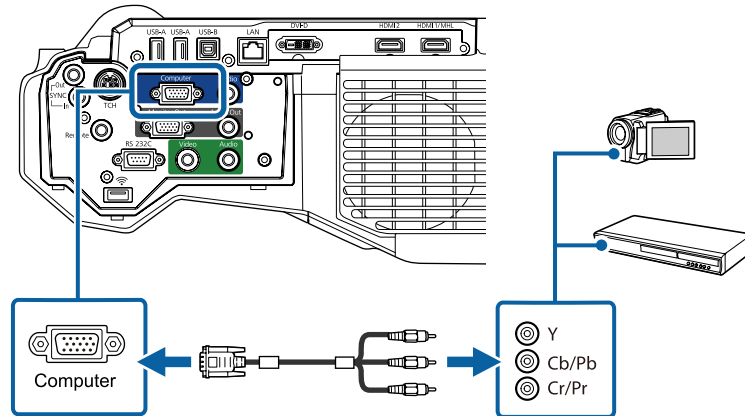

3 Tighten the screws on the VGA connector.

4 Connect the audio cable to your video source's audio-out ports.

5 Connect the other end to the projector's Audio 1 port.

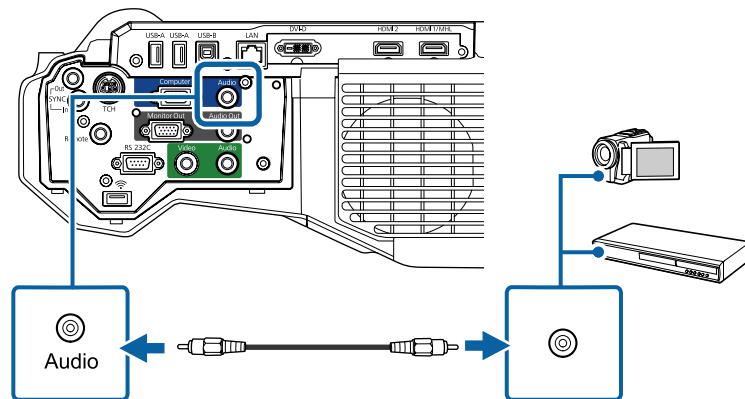

If your image colors appear incorrectly, you may need to change the **Input Signal** setting in the projector's **Signal** menu.

► **Related Links**

- "Input Signal Settings - Signal Menu" [p.208](#)

Connecting to a Composite Video Source

If your video source has a composite video port, you can connect it to the projector using a RCA-style video or A/V cable.

You can play sound through the projector's speaker system by connecting a stereo mini-jack audio cable.

 Make sure the audio cable is labeled "No resistance".

1 Connect the cable with the yellow connector to your video source's yellow video output port.

2 Connect the other end to the projector's Video port.

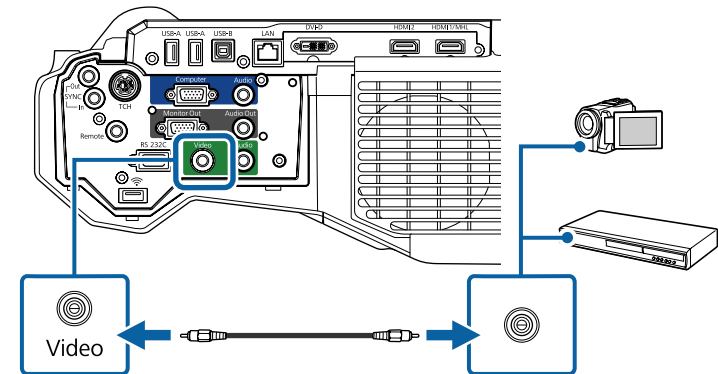

3 Connect the audio cable to your video source's audio-out ports.

- 4** Connect the other end to the projector's Audio 2 port.

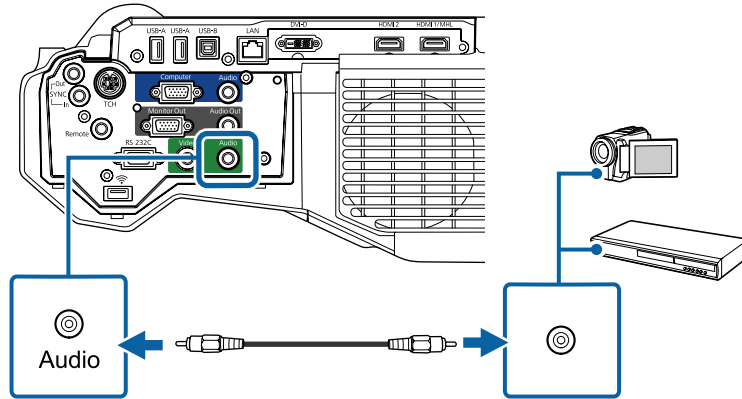

- Digital cameras or smartphones must be USB-mounted devices, not TWAIN-compliant devices, and must be USB Mass Storage Class-compliant.
- USB hard drives must meet these requirements:
 - USB Mass Storage Class-compliant (not all USB Mass Storage Class devices are supported)
 - Formatted in FAT or FAT32
 - Self-powered by their own AC power supplies (bus-powered hard drives are not recommended)
 - Avoid using hard drives with multiple partitions

You can project slide shows from image files on a connected USB device.

» Related Links

- "Projecting a PC Free Presentation" [p.143](#)

Connecting to External USB Devices

Follow the instructions in these sections to connect external USB devices to the projector.

» Related Links

- "USB Device Projection" [p.35](#)
- "Connecting to a USB Device" [p.35](#)
- "Connecting a USB Flash Drive to the Control Pad" [p.36](#)
- "Disconnecting a USB Device" [p.36](#)

USB Device Projection

You can project images and other content without using a computer or video device by connecting any of these devices to your projector:

- USB flash drive
- Digital camera or smartphone
- USB hard drive
- Multimedia storage viewer

Connecting to a USB Device

You can connect your USB device to the projector's USB-A port and use it to project images and other content.

1

If your USB device came with a power adapter, plug the device into an electrical outlet.

- 2 Connect the USB cable or USB flash drive to the projector's USB-A port as shown.

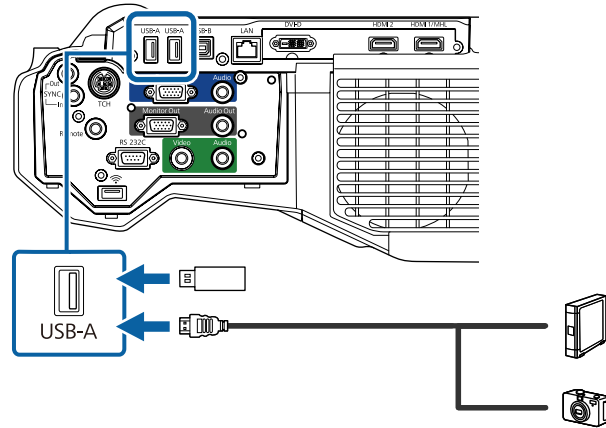

Attention

- Use the USB cable supplied with or specified for use with the device.
- Do not connect a USB hub or a USB cable longer than 3 meters, or the device may not operate correctly.



Select **USB1** as the image source when you connect a USB device to one of the USB-A ports.

- 3 Connect the other end to your device, if necessary.

Connecting a USB Flash Drive to the Control Pad

You can connect your USB flash drive to the USB-A port on the control pad and use it to project images and other content.



You can also connect a USB flash drive directly to the projector's USB-A port.

- 1 Connect the projector to the control pad.
- 2 Connect the USB flash drive into the USB-A port on the bottom of the control pad.

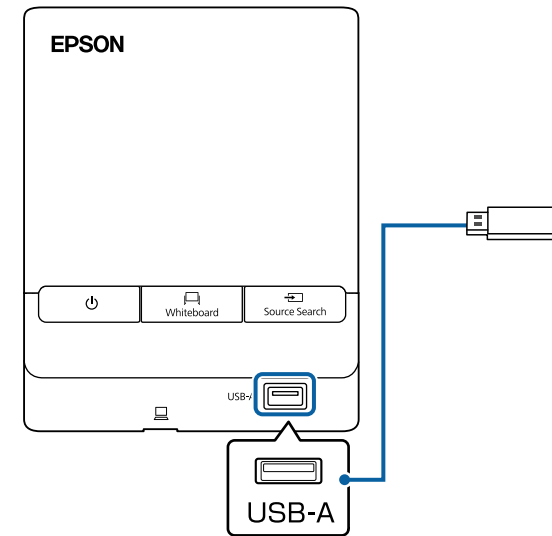

Select **USB1** as the image source to project images on the USB flash drive.

Disconnecting a USB Device

When you have finished presenting with a connected USB device, disconnect the device from the control pad or projector.

- 1 Turn off and unplug the device, if necessary.
- 2 Disconnect the USB device from the control pad or projector.

Connecting a Printer to the Control Pad

You can connect an Epson printer or all-in-one device to the Printer port (USB-A port) on the control pad and use it to print your projected and annotated content from the whiteboard.



- Make sure the printer meets the control command requirements.
- You can also connect a printer directly to the projector's USB-A port.
- You can also connect a network printer through the **Whiteboard Settings** menu.
 - ➔ **Extended > Whiteboard Settings > Print**

1 Connect the projector to the control pad.

2 Connect another USB cable to the Printer port (USB-A port) on the control pad. Make sure the cable is no longer than 5 m.

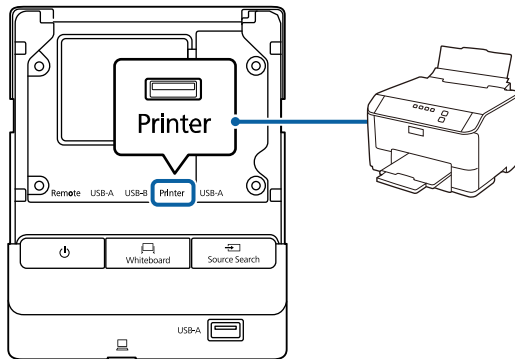

3 Connect the other end of the cable to the USB type B port on the printer.

Connecting to a Document Camera

You can connect a document camera to your projector to project images viewed by the camera.

The connection method varies depending on your Epson document camera model. See the document camera manual for details.



- You cannot connect a document camera to the control pad.
- Select **USB2** as the image source when you connect a USB document camera to one of the USB-A ports.
- You cannot use multiple USB document cameras at the same time.

Connecting an External USB Keyboard to the Control Pad

You can connect an external USB keyboard to the USB-A port on the control pad and use it to enter numbers and characters.



- The English keyboard (101 keyboard) is supported.
- You can only use the connected keyboard to configure the remote desktop connection settings for a remote computer.

1 Connect the projector to the control pad.

- 2 Connect the keyboard's cable to your control pad's USB-A port.

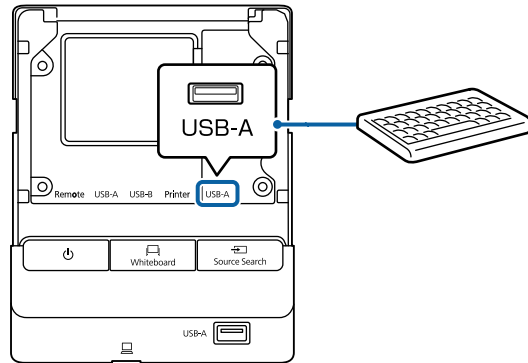

Connecting to External Output Devices

Follow the instructions in these sections to connect external devices to the projector.

» Related Links

- "Connecting to an External DVI Monitor" [p.38](#)
- "Connecting to a VGA Monitor" [p.39](#)
- "Connecting to External Speakers" [p.40](#)

Connecting to an External DVI Monitor

You can connect an external DVI monitor to the projector's DVI-D Out port. If you connect your projector to another projector using the DVI-D Out port, you can easily project your presentation onto a large screen.

Attention

Do not turn on the DVI monitor or other large-size projectors before connecting them to the projector. Doing so could damage the projector.



- Images cannot be output to an external DVI monitor when the projector is turned off.
- The refresh interval of the image displayed on the DVI monitor varies depending on the image source.
 - The image from the whiteboard refreshes in real time.
 - Images from sources other than the whiteboard refresh every three seconds.
- When performing split screen projection, and if you do not want to display images from the HDMI2 port, select **Off** as the **HDMI2 Out (Split Screen)** setting in the projector's **Extended** menu.
 - ☛ **Extended > A/V Settings > HDMI2 Out (Split Screen)**
- The following images cannot be displayed on the DVI monitor. A message is displayed on the screen, and then the screen blacks out.
 - Images protected by HDCP
 - Images that cannot be displayed on external monitors such as the Home screen
- When the projector is busy, images cannot be displayed on the DVI monitor. A message is displayed on the screen, and then the screen blacks out.

- 1 Connect the DVI-D 24-pin cable to the projector's DVI-D Out port.
- 2 Connect the other end to your monitor's DVI-D port.

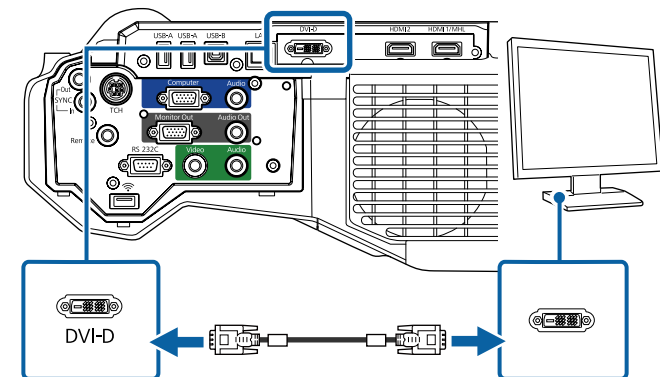

3 Select the **Extended** menu and press [Enter].

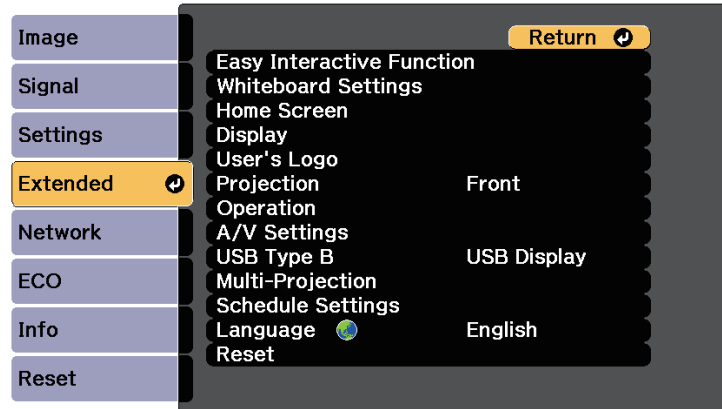

4 Select the **A/V Settings** setting and press [Enter].

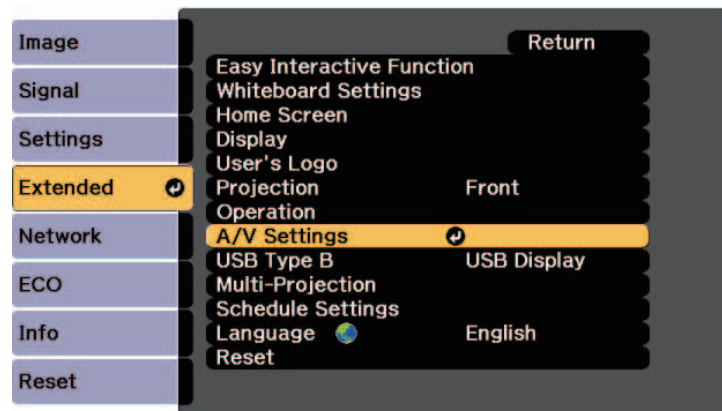

5 Select **DVI Output** and press [Enter].

6 Select the image source you want to display on the DVI monitor.

- Whiteboard: Displays whiteboard screen.
- Projected Image: Displays currently projected image source.

7 Press [Menu] or [Esc] to exit the menus.

Connecting to a VGA Monitor

If you connected the projector to a computer using a Computer port, you can also connect an external monitor to the projector. This lets you see your presentation on the external monitor even when the projected image is not visible.



- If you want to output images to an external monitor when the projector is turned off, you need to do the following:
 - Select **Communication On** as the **Standby Mode** setting in the projector's **ECO** menu.
 - Select **Always On** as the **A/V Output** setting in the projector's **Extended** menu.
 - ➔ **Extended > A/V Settings > A/V Output**
 - Content drawn on the screen using the interactive features is not displayed on an external monitor. To display the drawn content on an external monitor, use the supplied Easy Interactive Tools.
 - Monitors that use a refresh rate of less than 60 Hz may not be able to display images correctly.

1 Make sure your computer is connected to the projector's Computer port.



- Only analog RGB signals from the Computer port can be output to an external monitor. You cannot output signals input from other ports or component video signals.

- 2 Connect the external monitor's cable to your projector's Monitor Out port.

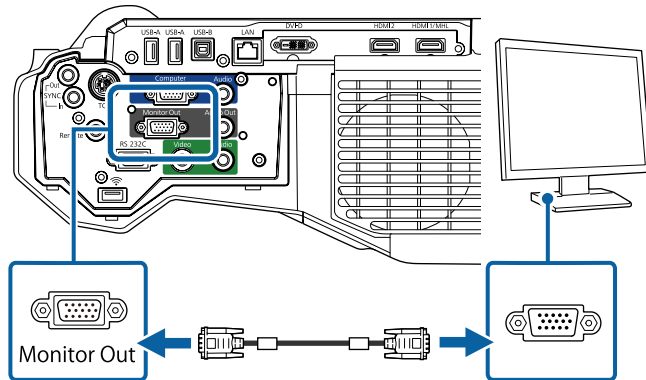

Connecting to External Speakers

To enhance the sound from your presentation, you can connect the projector to external self-powered speakers. You can control the volume using the projector's remote control.



- If you want to output audio from the external speakers when the projector is turned off, you need to do the following:
 - Select **Communication On** as the **Standby Mode** setting in the projector's **ECO** menu.
 - Select **Always On** as the **A/V Output** setting in the projector's **Extended** menu.
 - ☛ **Extended > A/V Settings > A/V Output**
- You can also connect the projector to an amplifier with speakers.
- The projector's built-in speaker system is disabled when you connect external speakers.

- 1 Make sure your computer or video source is connected to the projector with both audio and video cables as necessary.

- 2 Locate the appropriate cable to connect your external speakers, such as a stereo mini-jack-to-pin-jack cable, or another type of cable or adapter.

- 3 Connect one end of the cable to your external speakers as necessary.

- 4 Connect the stereo mini-jack end of the cable to your projector's Audio Out port.

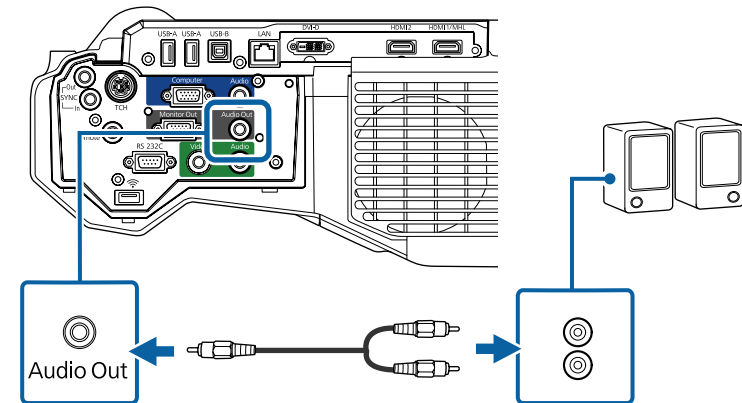

Connecting Multiple Projectors of the Same Model

If you use the interactive features of multiple projectors of the same model in the same room, you need to synchronize the projectors. To do this, connect the optional remote control cable set to the SYNC port on each projector.

- 1 Connect one end of the cable to the SYNC IN port on one projector, and connect the other end to the SYNC OUT port on the other projector.

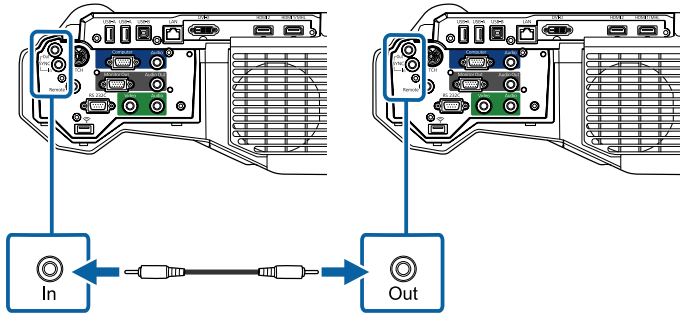

 If you are connecting three or more projectors, connect the projectors in a chain as shown.

The diagram illustrates a chain of three projectors. The first projector's SYNC OUT port is connected to the second projector's SYNC IN port. The second projector's SYNC OUT port is connected to the third projector's SYNC IN port. Below each projector, a small inset shows the 'In' and 'Out' ports.

- 2 Press the [Menu] button on the control panel or remote control.

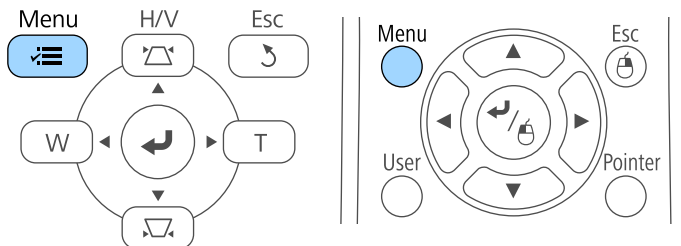

- 3 Select the **Extended** menu and press [Enter].

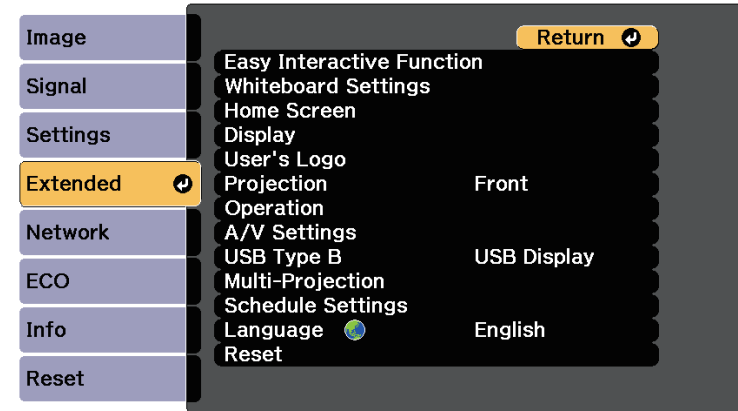

- 4 Select the **Easy Interactive Function** setting and press [Enter].

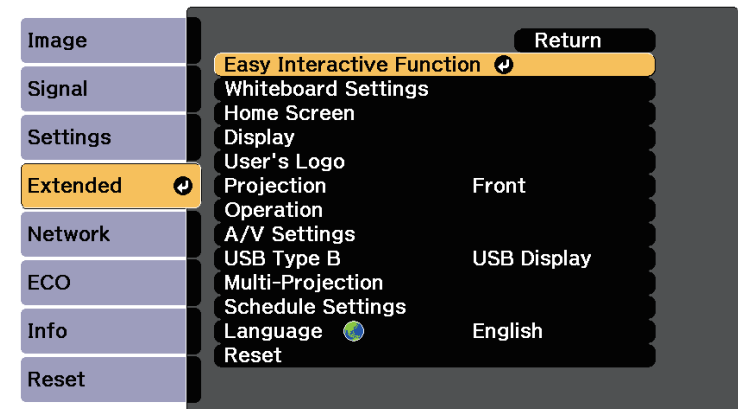

- 5** In the **General** section, select **Advanced**, and then press [Enter].

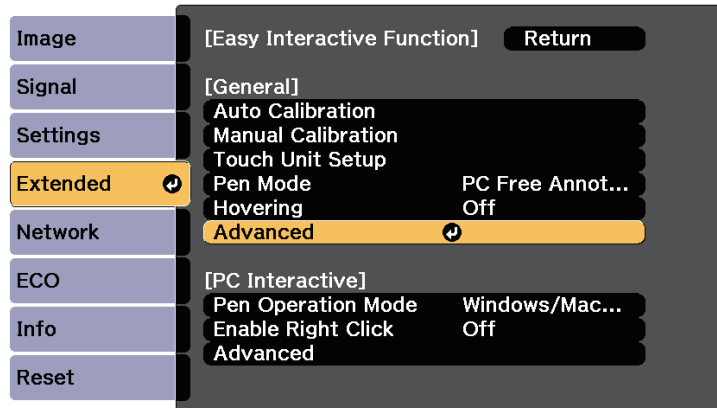

- If you are using the projector in the same room as another projector that does not support cable connection, set the **Wired Sync Mode** setting to **Mode 2** in the projector's **Extended** menu.
☛ **Extended > Easy Interactive Function > General > Advanced > Wired Sync Mode**
- If you do not have the optional remote control cable set, change the **Distance of Projectors** setting in the projector's **Extended** menu.
☛ **Extended > Easy Interactive Function > General > Advanced > Distance of Projectors**

- 6** Select **Sync of Projectors** and press [Enter].

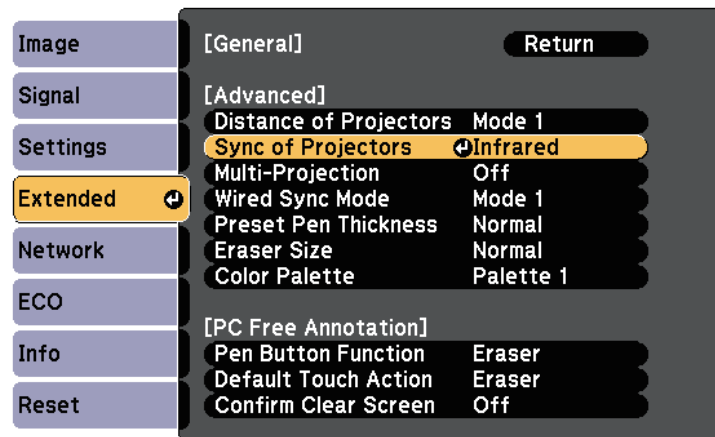

- 7** Select **Wired** and press [Enter].

- 8** Press [Menu] or [Esc] to exit the menus.

The remote control uses the two AA batteries that came with the projector.

Attention

Make sure you read the *Safety Instructions* before handling the batteries.

- 1 Remove the battery cover as shown.

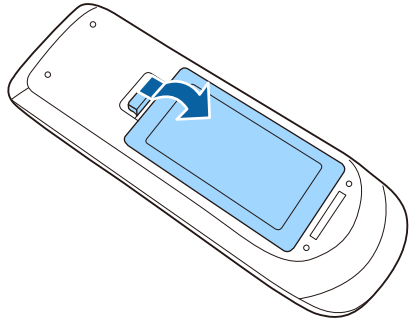

- 2 Insert the batteries with the + and - ends facing as shown.

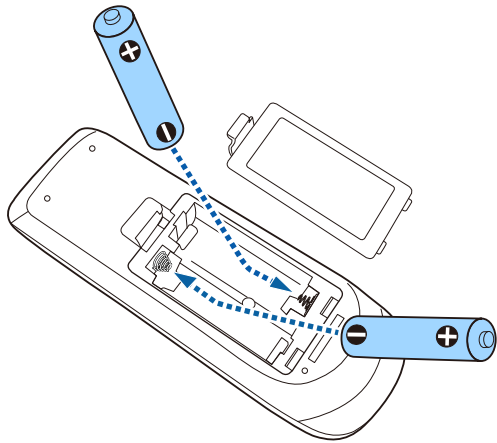

Warning

Check the positions of the (+) and (-) marks inside the battery holder to ensure the batteries are inserted the correct way. If the batteries are not used correctly, they could explode or leak causing a fire, injury, or damage to the product.

- 3 Replace the battery cover and press it down until it clicks into place.

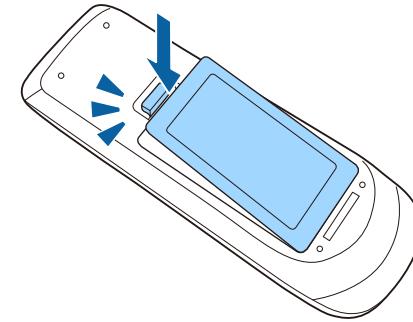

Each pen uses one AA battery.

Attention

Make sure you read the *Safety Instructions* before handling the battery.

- 1 Open the battery cover as shown.

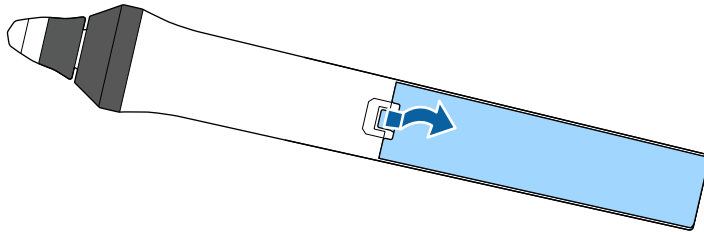

- 2 Insert the battery with the + and - ends facing as shown.

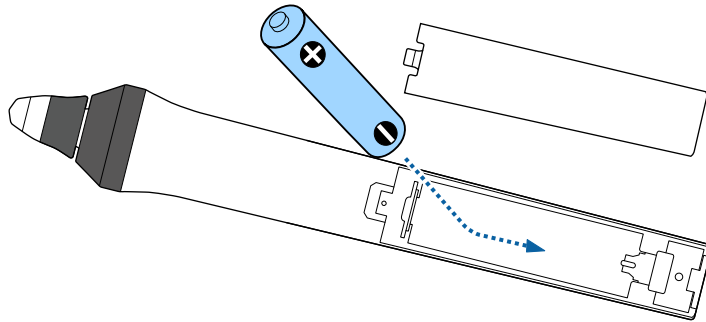

Warning

Check the positions of the (+) and (-) marks inside the battery holder to ensure the battery are inserted the correct way. If the battery is not used correctly, it could explode or leak causing a fire, injury, or damage to the product.

- 3 Replace the battery cover and press it down until it clicks into place.

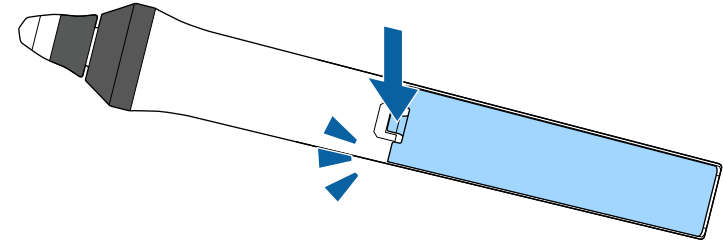

The remote control lets you control the projector from almost anywhere in the room.

Make sure that you aim the remote control at the projector's receivers within the distance and angles listed here.

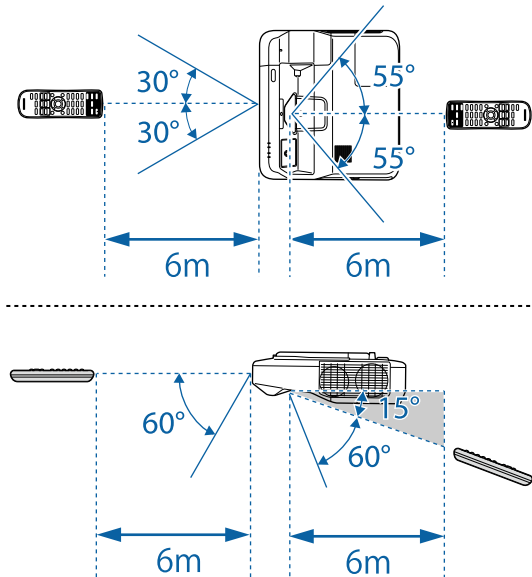

Avoid using the remote control in conditions with bright fluorescent lights or in direct sunlight, or the projector may not respond to commands. If you are not going to use the remote control for a long time, remove the batteries.

Using Basic Projector Features

Follow the instructions in these sections to use your projector's basic features.

► Related Links

- "Turning On the Projector" [p.47](#)
- "Turning Off the Projector" [p.50](#)
- "Setting the Date and Time" [p.51](#)
- "Selecting the Language for the Projector Menus" [p.53](#)
- "Projection Modes" [p.54](#)
- "Focusing the Image" [p.56](#)
- "Image Shape" [p.59](#)
- "Resizing the Image with the Buttons" [p.66](#)
- "Adjusting the Image Position" [p.67](#)
- "Selecting an Image Source" [p.68](#)
- "Image Aspect Ratio" [p.70](#)
- "Color Mode" [p.72](#)
- "Adjusting the Image Color" [p.74](#)
- "Controlling the Volume with the Volume Buttons" [p.77](#)

Turn on the computer or video equipment you want to use after you turn on the projector.

- 1** Connect the power cord to the projector's power inlet and plug it into an electrical outlet.

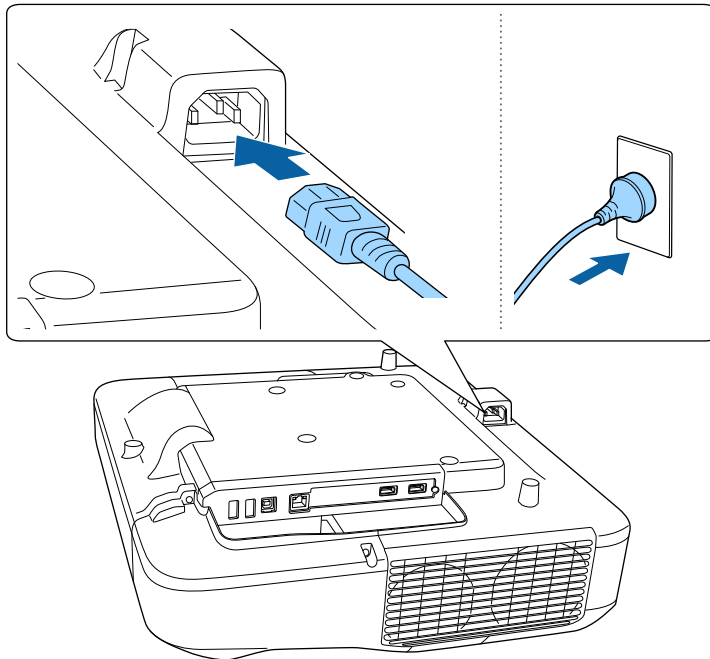

The projector's power indicator turns blue. This indicates that the projector is receiving power, but is not yet turned on (it is in standby mode).

- 2** Press the power button on the control panel or remote control to turn on the projector.



You can also press the power button on the control pad.

The projector beeps and the status indicator flashes blue as the projector warms up. Once the projector is warmed up, the status indicator stops flashing and turns blue.

Try the following if you do not see a projected image.

- Turn on the connected computer or video device.
- Change the screen output from the computer when using a laptop computer.
- Insert a DVD or other video media, and press play (if necessary).
- Press the [Source Search] button on the control pad, remote control, or control panel to detect the source.
- Press the button for the desired video source on the remote control.
- If the Home screen is displayed, select the source you want to project.

⚠ Warning

- Never look into the projector lens when the lamp is on. This can damage your eyes and is especially dangerous for children.
 - When turning on the projector at a distance using the remote control, make sure there is no one looking into the lens.
 - During projection, do not block the light from the projector with a book or other objects. If the light from the projector is blocked, the area on which the light shines becomes hot which could cause it to melt, burn, or start a fire. Also, the lens may get hot due to the reflected light which could cause the projector to malfunction. To stop projection, use the A/V Mute function, or turn off the projector.
 - A mercury lamp with high internal pressure is used as the projector's light source. If the lamp is subjected to vibrations or shocks, or if it is used for an overly extended length of time, the lamp may break or it may not turn on. If the lamp explodes, gases may escape and small fragments of glass may be scattered which could cause an injury. Be sure to observe the instructions below.
 - Do not disassemble or damage the lamp or subject it to any impacts.
 - Do not bring your face close to the projector while it is in use.
 - Particular care should be taken when the projector is installed to a wall or ceiling, as small pieces of glass may fall down when the lamp cover is removed. When cleaning the projector or replacing the lamp yourself, be very careful not to allow such pieces of glass to get into the eyes or mouth.
- If the lamp breaks, ventilate the area immediately, and contact a doctor if any fragments of broken glass are inhaled or get into the eyes or mouth.



- When the **Direct Power On** setting is set to **On** in the projector's **Extended** menu, the projector turns on as soon as you plug it in. Note that the projector also turns on automatically in cases such as recovery from a power outage.
 - ☛ **Extended > Operation > Direct Power On**
- If you select a specific port as the **Auto Power On** setting in the projector's **Extended** menu, the projector turns on as soon as it detects a signal or cable connection from that port.
 - ☛ **Extended > Operation > Auto Power On**

- "Projector Setup Settings - Extended Menu" [p.213](#)
- "Projector Setup Settings - ECO Menu" [p.233](#)

Home Screen

The Home screen feature allows you to easily select an image source and access useful functions. You can display the Home screen by pressing the [Home] button on the control panel or remote control. The Home screen is also displayed when you turn on the projector and no signal is being input from the selected input source.

Press the arrow buttons on the control panel or remote control to select a menu item, and then press [Enter].

You can also select menu items using the interactive pen or your finger (EB-1450Ui).

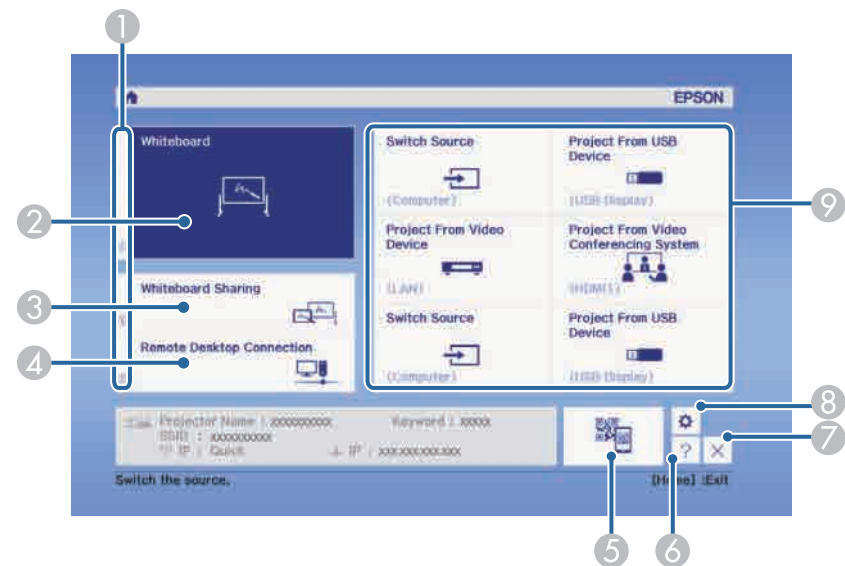

- 1 Displays a description of the function.
- 2 Starts whiteboard mode.

» Related Links

- "Home Screen" [p.48](#)

- ③ Shares your whiteboard screen with other devices, or connects to a shared projector to view the whiteboard screen.
- ④ Connects to a remote computer and allows you to control it.
- ⑤ Displays the QR code and projects data on a smartphone or tablet device.
- ⑥ Displays the projector's Help screen.
- ⑦ Closes the Home screen.
- ⑧ Makes temporary settings for the interactive features.
- ⑨ Performs menu options assigned to **Home Screen** in the projector's **Extended** menu.



The Home screen disappears after 10 minutes of inactivity.

► Related Links

- "Image Shape" [p.59](#)
- "Projector Setup Settings - Extended Menu" [p.213](#)
- "Using a QR Code to Connect a Mobile Device" [p.182](#)
- "Using the Projector's Menus" [p.204](#)
- "Using the Projector Help Displays" [p.262](#)
- "Connecting to a Computer" [p.28](#)

Turn off the projector after use.

Attention

Do not unplug the power cord while the projector is turned on. Data on the whiteboard may be lost.



- Turn off this product when it is not in use to prolong the life of the projector. Lamp life varies depending on the mode selected, environmental conditions, and usage. Brightness decreases over time.
- If **Auto Delete Saved Data** is set to **Retain** in the **Extended** menu, you can select whether or not to clear the data on the whiteboard when you turn off the projector.
➔ **Extended > Whiteboard Settings > Policy**

- 1** Press the power button on the control panel or remote control.



You can also press the power button on the control pad.

The projector displays a shutdown confirmation screen.



- 2** Press the power button again. (To leave it on, press any other button.)
The projector beeps twice, the lamp turns off, and the status indicator turns off.

- 3** To transport or store the projector, make sure the power indicator is blue (but not flashing) and the status indicator is off, then unplug the power cord.

You can set the date and time for the projector.

- 1** Turn on the projector.
- 2** Press the [Menu] button on the control panel or remote control.

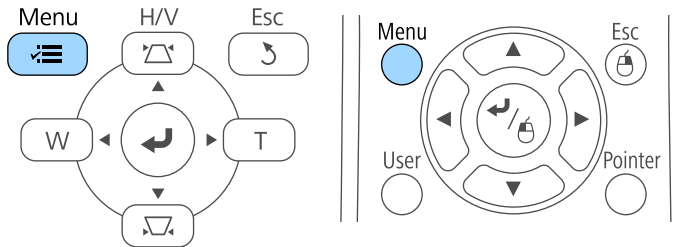

- 3** Select the **Extended** menu and press [Enter].
- 4** Select the **Operation** setting and press [Enter].
- 5** Select the **Date & Time** setting and press [Enter].

You see this screen:

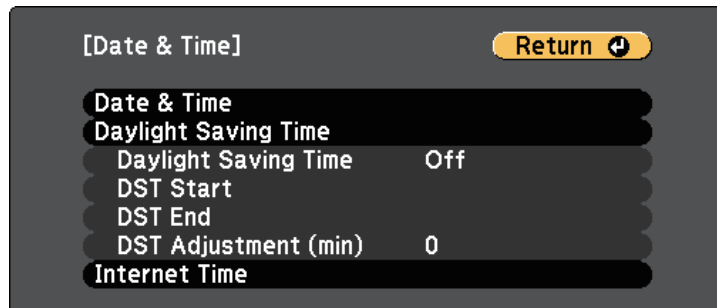

- 6** Select the **Date & Time** setting and press [Enter].

You see this screen:

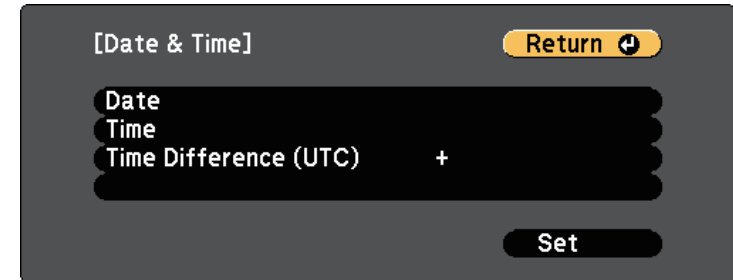

- 7** Select **Date**, press [Enter], and use the displayed keyboard to enter today's date.
- 8** Select **Time**, press [Enter], and use the displayed keyboard to enter the current time.
- 9** Select **Time Difference (UTC)**, press [Enter], and set the time difference from Coordinated Universal Time.
- 10** When you are finished, select **Set** and press [Enter].

- 11** To activate daylight saving time, select the **Daylight Saving Time** setting and press [Enter]. Then select settings.

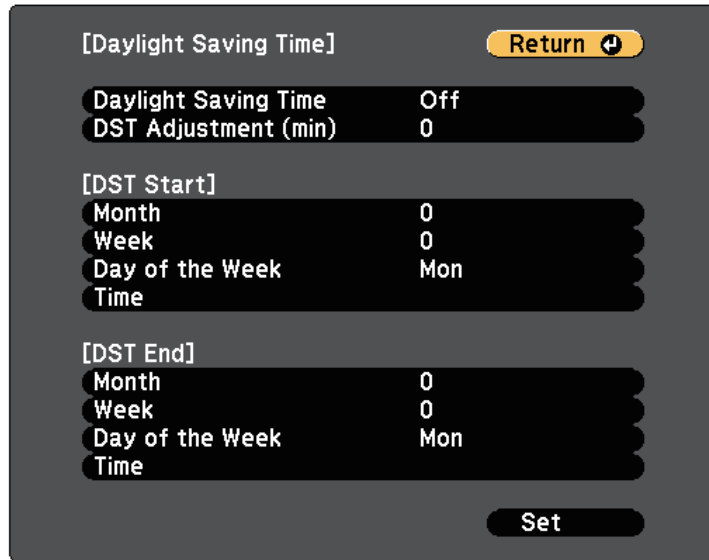

- 15** Press [Menu] or [Esc] to exit the menus.

- 12** When you are finished, select **Set** and press [Enter].

- 13** To update the time automatically through an Internet time server, select the **Internet Time** setting and press [Enter]. Then select settings.

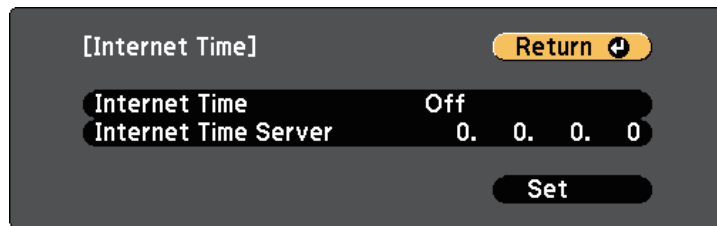

- 14** When you are finished, select **Set** and press [Enter].

If you want to view the projector's menus and messages in another language, you can change the **Language** setting.

- 1 Turn on the projector.
- 2 Press the [Menu] button on the control panel or remote control.

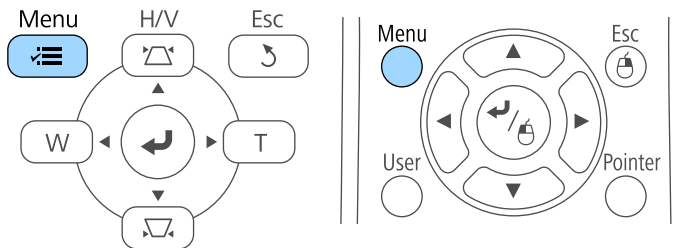

- 6 Press [Menu] or [Esc] to exit the menus.

- 3 Select the **Extended** menu and press [Enter].

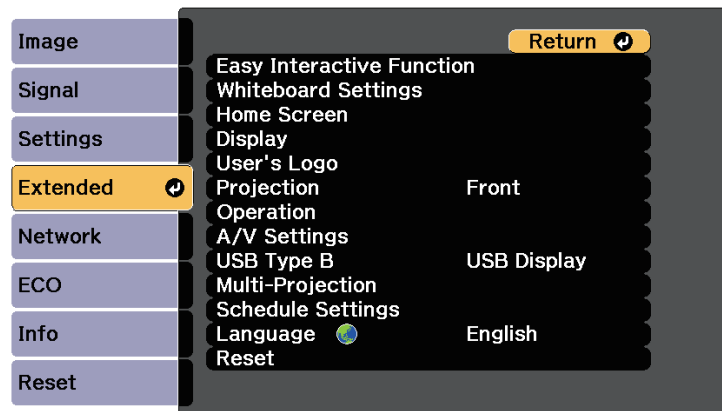

- 4 Select the **Language** setting and press [Enter].
- 5 Select the language you want to use and press [Enter].

Depending on how you positioned the projector, you may need to change the projection mode so your images project correctly.

- **Front** lets you project from a table in front of the screen.
- **Front/Upside Down** (default setting) flips the image over top-to-bottom to project upside-down from a ceiling or wall mount.
- **Rear** flips the image horizontally to project from behind a translucent screen.
- **Rear/Upside Down** flips the image over top-to-bottom and horizontally to project from a ceiling or wall mount and behind a translucent screen.

» **Related Links**

- "Changing the Projection Mode Using the Remote Control" [p.54](#)
- "Changing the Projection Mode Using the Menus" [p.54](#)
- "Projector Setup and Installation Options" [p.25](#)

Changing the Projection Mode Using the Remote Control

You can change the projection mode to flip the image over top-to-bottom.

- 1** Turn on the projector and display an image.
- 2** Hold down the [A/V Mute] button on the remote control for 5 seconds.

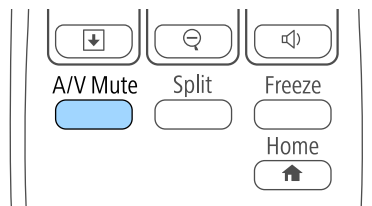

The image disappears briefly and reappears flipped top-to-bottom.

- 3** To change projection back to the original mode, hold down the [A/V Mute] button for 5 seconds again.

Changing the Projection Mode Using the Menus

You can change the projection mode to flip the image over top-to-bottom and/or left-to-right using the projector menus.

- 1** Turn on the projector and display an image.
- 2** Press the [Menu] button on the control panel or remote control.

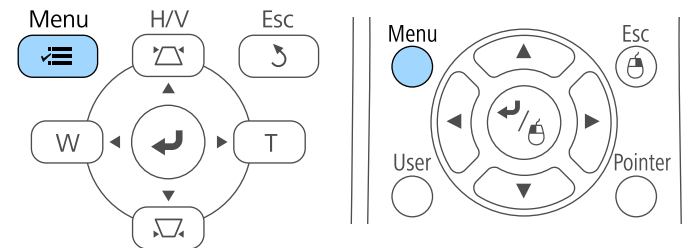

- 3** Select the **Extended** menu and press [Enter].

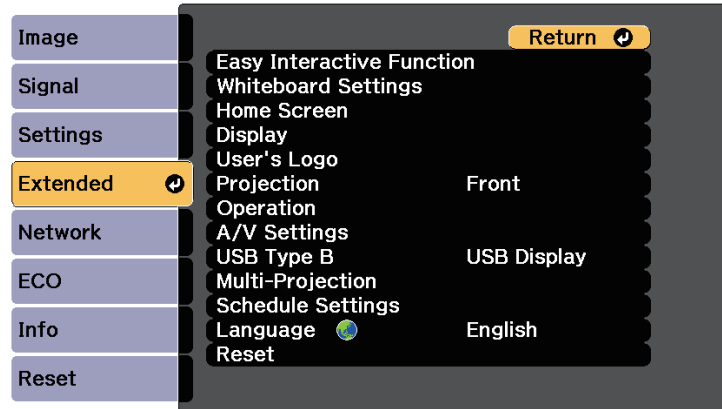

- 4** Select **Projection** and press [Enter].

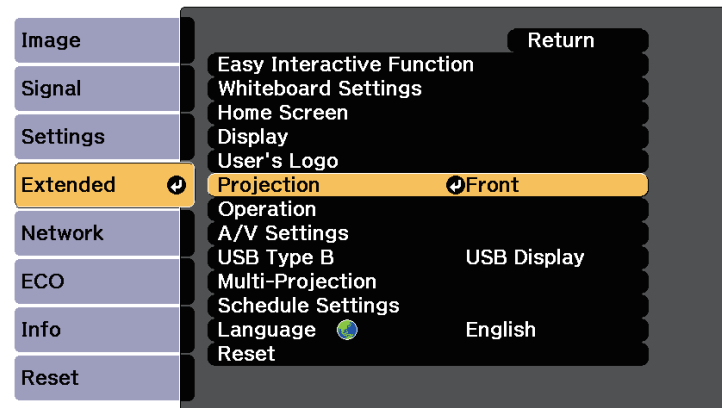

- 5** Select a projection mode and press [Enter].

- 6** Press [Menu] or [Esc] to exit the menus.

You can display the test pattern, and then adjust the focus.

1 Press the [Menu] button on the control panel or remote control.

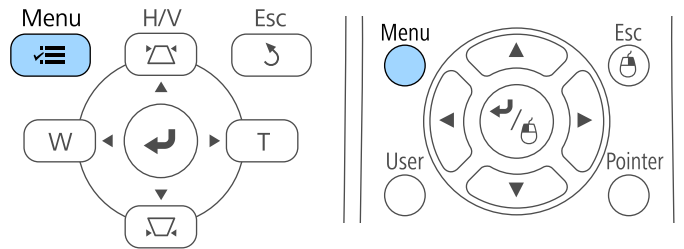

2 Select the **Settings** menu and press [Enter].

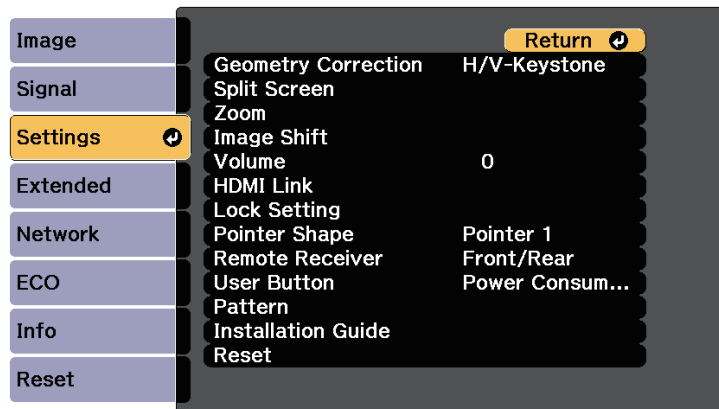

3 Select **Pattern** and press [Enter].

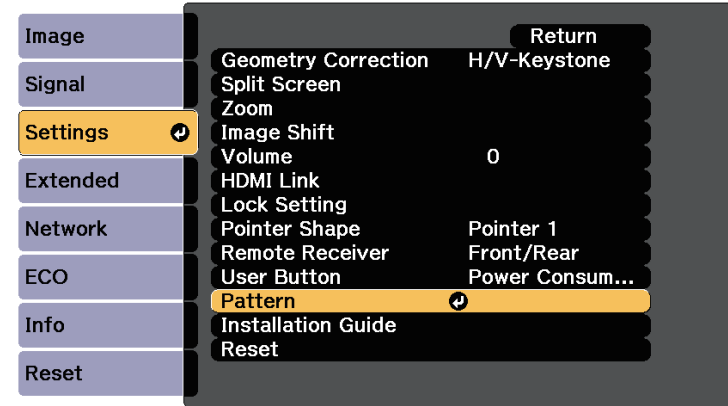

4 Select **Test Pattern** and press [Enter].

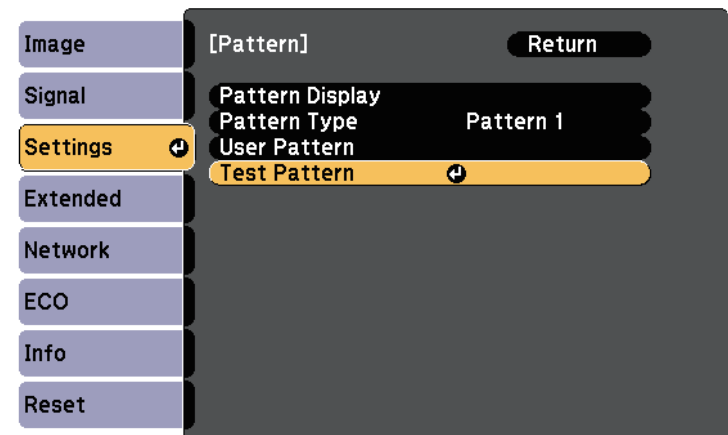

5 Open the air filter cover.

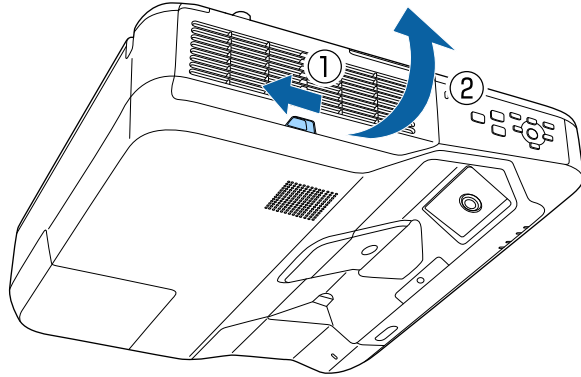

6 Move the focus lever and focus to the center-bottom of the projected screen.

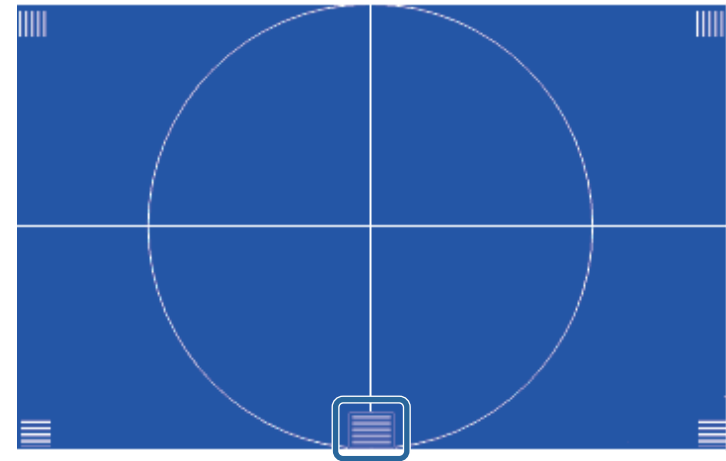
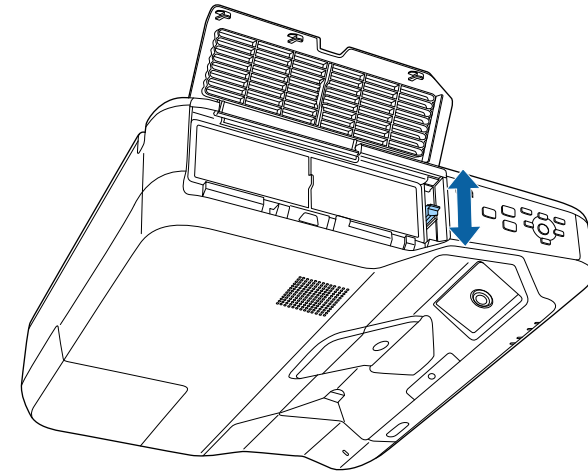

7 Check that the focus matches the corners of the projected screen.

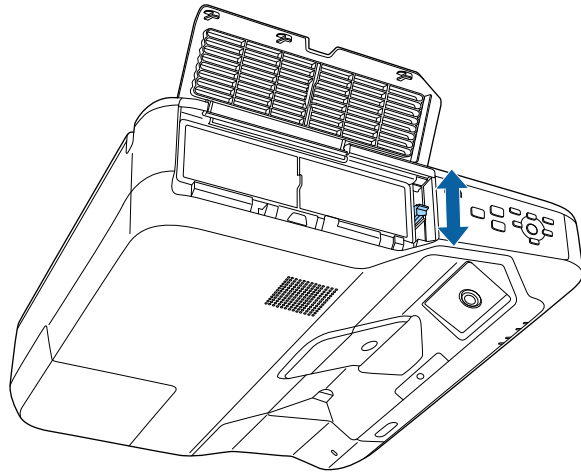

8 To remove the test pattern, press the [Esc] button on the remote control or the control panel.

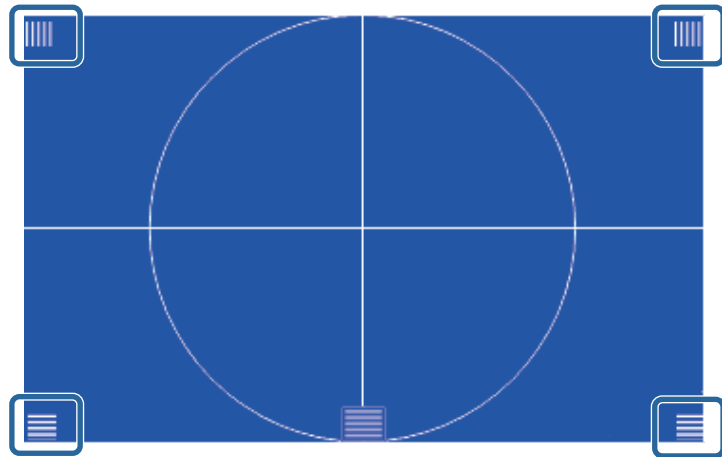

If any areas are out of focus, use the focus lever to adjust until the corners are the same focus.

You can project an even, rectangular image by placing the projector directly in front of the center of the screen and keeping it level. If you place the projector at an angle to the screen, or tilt it up or down, or off to the side, you may need to correct the image shape.



You cannot correct an image shape using multiple correction methods at the same time.

» Related Links

- "Correcting the Image Shape with the Keystone Buttons" [p.59](#)
- "Correcting the Image Shape with Quick Corner" [p.60](#)
- "Correcting Image Shape with Curved Surface" [p.62](#)

Correcting the Image Shape with the Keystone Buttons

You can use the projector's keystone correction buttons to correct the shape of an image that is unevenly rectangular.

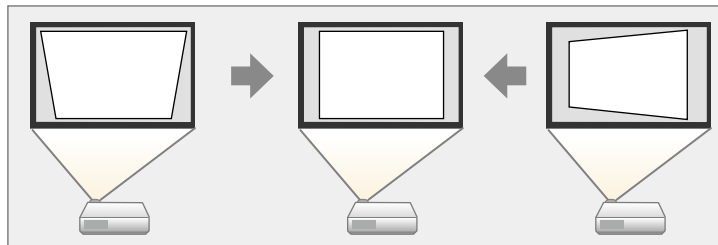

You can use keystone buttons to correct images up to 3° right, left, up, or down.

- 1** Turn on the projector and display an image.

- 2** Press one of the keystone adjustment buttons on the control panel to display the Keystone adjustment screen.

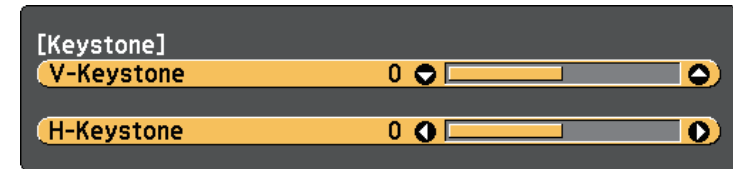
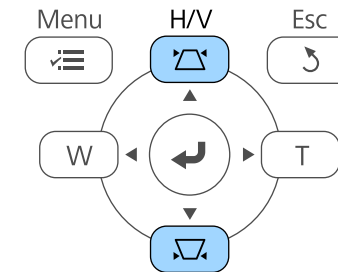

3 Press a keystone button to adjust the image shape.

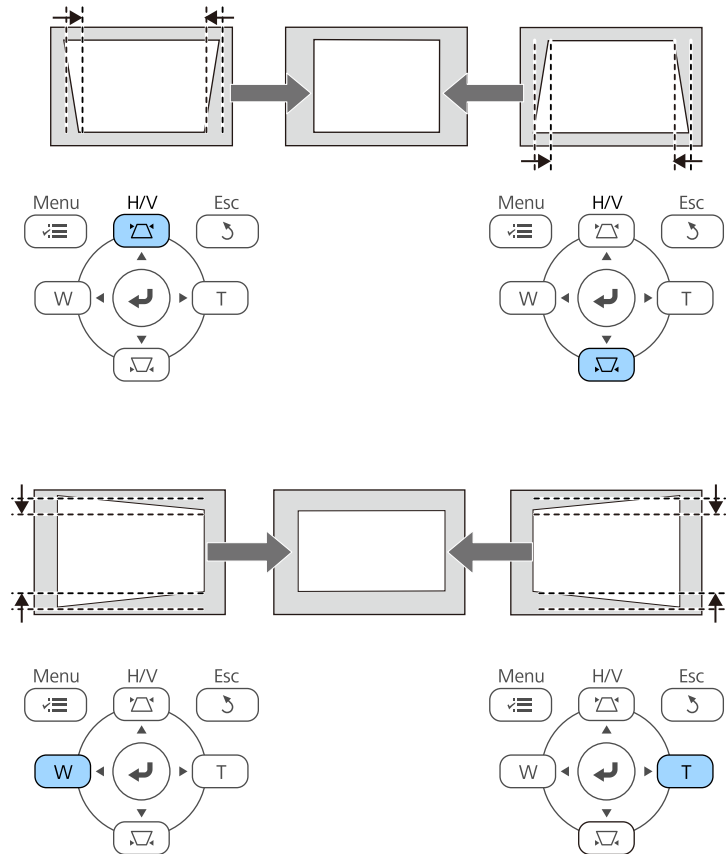

After correction, your image is slightly smaller.

 If the projector is installed out of your reach, you can also correct the shape of the image using the remote control.
Settings > Geometry Correction > H/V-Keystone

» **Related Links**

- "Projector Feature Settings - Settings Menu" [p.210](#)

Correcting the Image Shape with Quick Corner

You can use the projector's Quick Corner setting to correct the shape and size of an image that is unevenly rectangular.

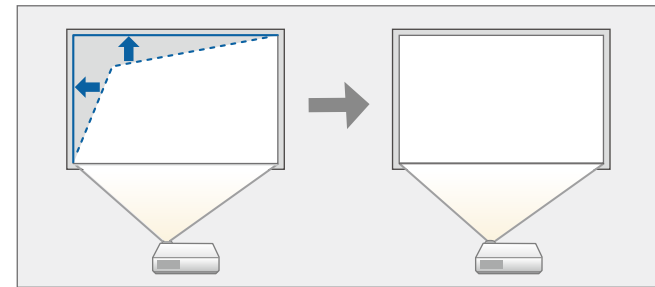

- 1** Turn on the projector and display an image.
- 2** Press the [Menu] button on the control panel or remote control.

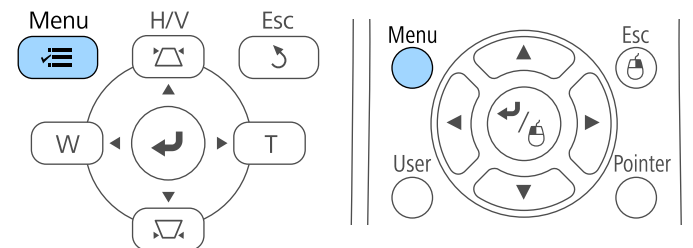

3 Select the **Settings** menu and press [Enter].

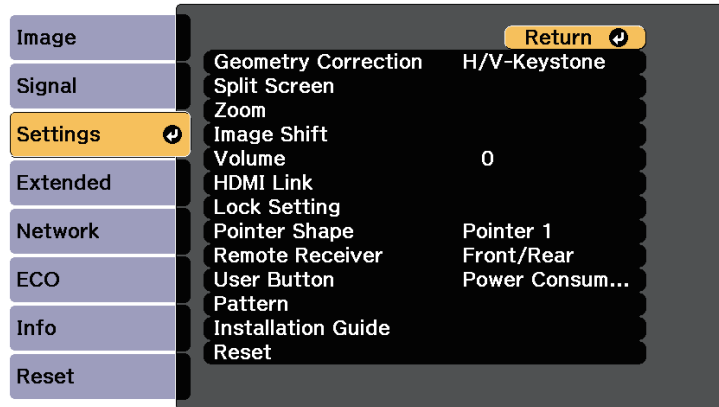

4 Select **Geometry Correction** and press [Enter].

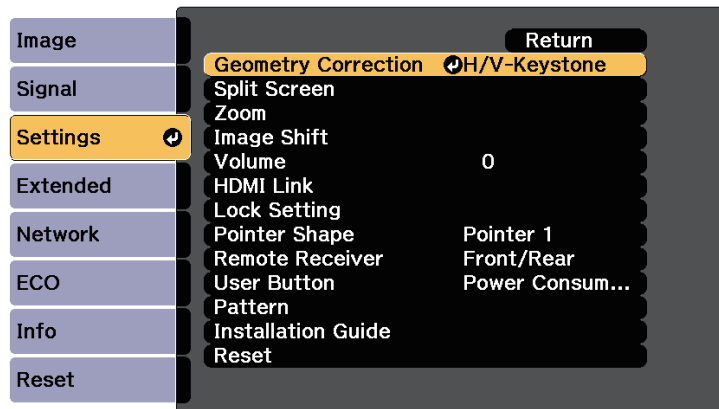

5 Select **Quick Corner** and press [Enter]. Press [Enter] again if necessary.

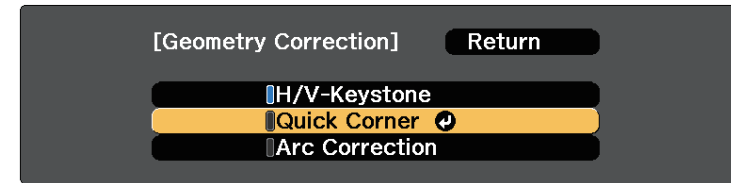

You see the area selection screen.

6 Use the arrow buttons to select the corner of the image you want to adjust. Then press [Enter].

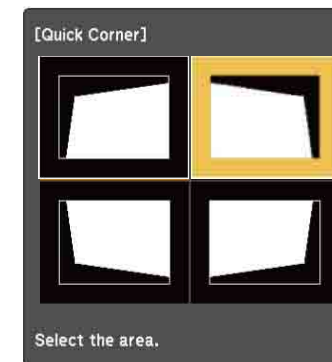

To reset the Quick Corner corrections, hold down [Esc] for about two seconds while the area selection screen is displayed, and then select **Yes**.

7 Press the arrow buttons to adjust the image shape as necessary. To return to the area selection screen, press [Enter].

 If you see this screen, you cannot adjust the shape any further in the direction indicated by the gray triangle.

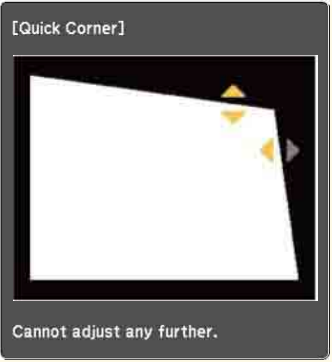

8 Repeat steps 6 and 7 as needed to adjust any remaining corners.

9 When you are finished, press [Esc].

The **Geometry Correction** setting is now set to **Quick Corner** in the projector's **Settings** menu. The next time you press the keystone adjustment buttons on the control panel, the area selection screen is displayed.

» **Related Links**

- "Projector Feature Settings - Settings Menu" [p.210](#)

Correcting Image Shape with Curved Surface

You can use the projector's Arc Correction setting to adjust the shape of an image projected on a curved or spherical surface.

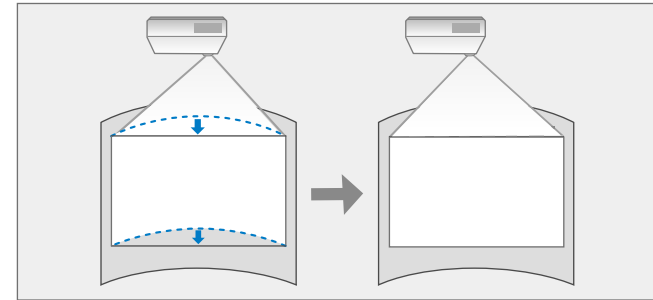

1 Turn on the projector and display an image.

2 Press the [Menu] button on the control panel or remote control.

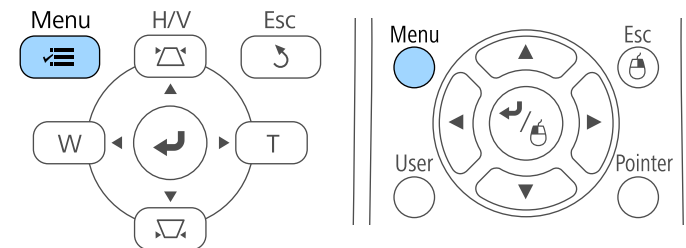

3 Select the **Settings** menu and press [Enter].

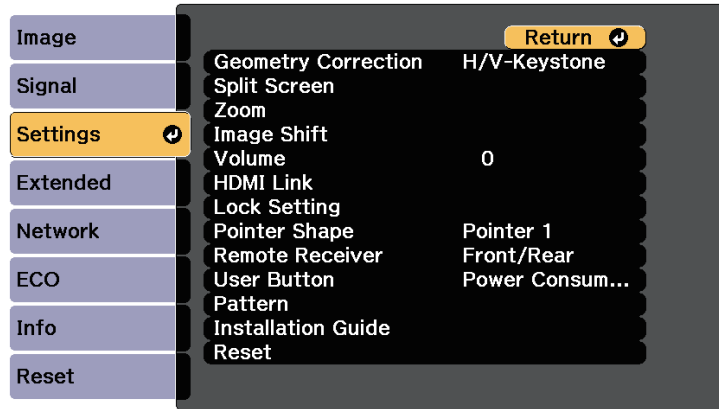

4 Select **Geometry Correction** and press [Enter].

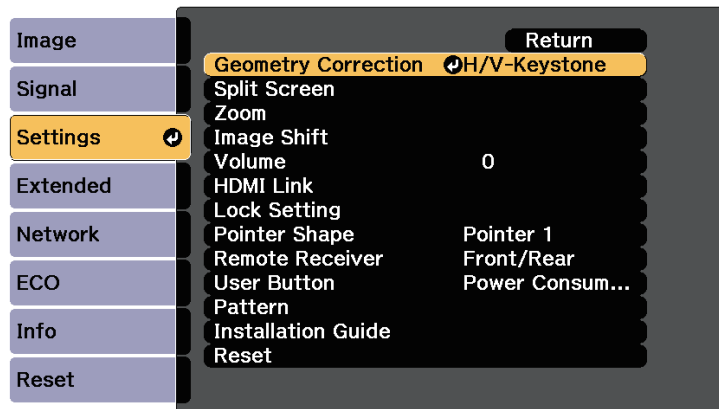

5 Select **Arc Correction** and press [Enter].

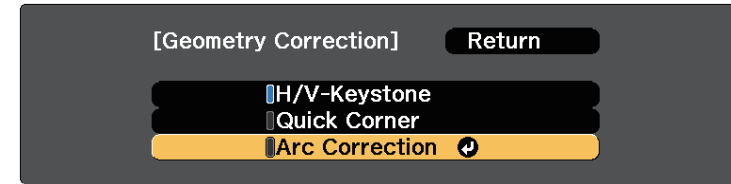

6 Select **Arc Correction** and press [Enter].

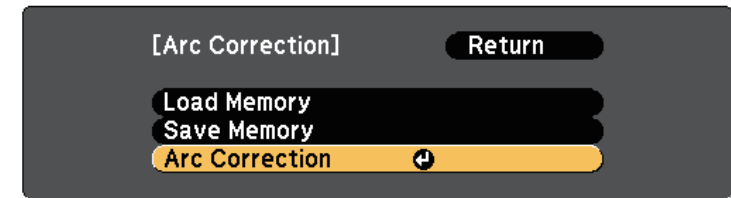

You see the area selection screen.

7 Use the arrow buttons to select the area of the image you want to adjust, then press [Enter].

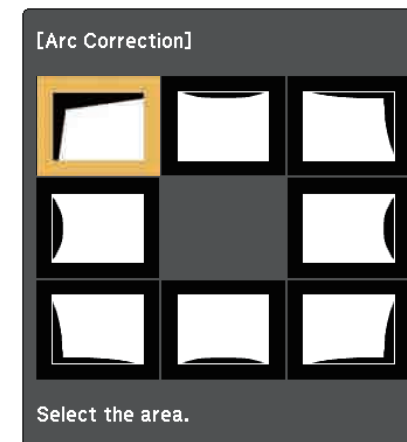



To reset the Arc Correction settings, hold down [Esc] for about two seconds while the area selection screen is displayed, and then select **Yes**.

8 Press the arrow buttons to adjust the image shape of the selected area as necessary.

To return to the area selection screen, press [Enter].



If you see this screen, you cannot adjust the shape any further in the direction indicated by the gray triangle.

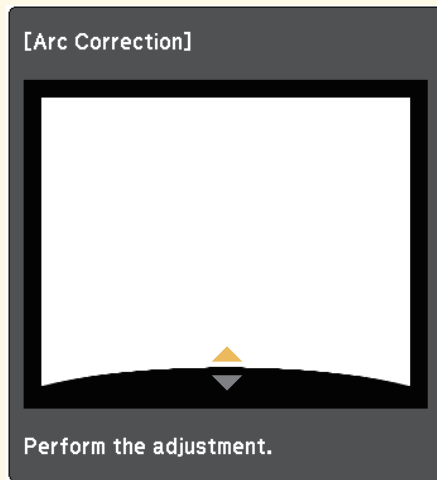

9 Repeat steps 7 and 8 as needed to adjust any remaining areas.

10 When you are finished, press [Esc].



To save the current shape of an image you have adjusted, select **Save Memory** in the **Arc Correction** setting. You can save up to three image shapes in the Arc Correction memory.

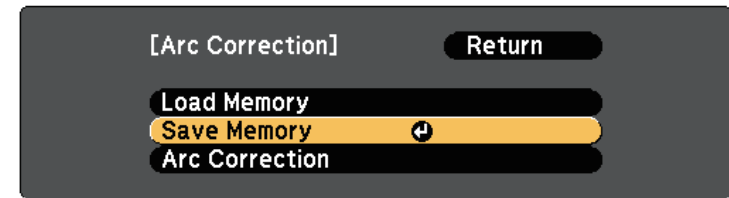

» Related Links

- "Loading Image Shape Setting from Memory" [p.64](#)

Loading Image Shape Setting from Memory

You can load the settings you made and saved in the **Arc Correction** setting.



Before loading the memory, make sure the **Geometry Correction** setting is set to **Arc Correction** in the projector's **Settings** menu.

1 Turn on the projector and display an image.

- 2** Hold down the [Num] button on the remote control, and then press the numeric button (1, 2, or 3) that matches the number of the saved setting.

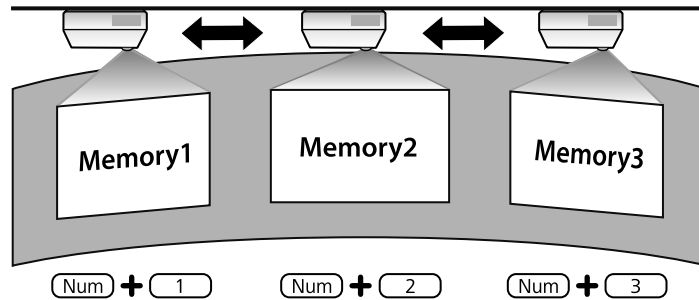

The illustration above is only an example.

- 3** When you have finished loading the settings, follow the on-screen instructions.



- You can also load the settings from **Load Memory** in the projector's **Settings** menu.
 - When an MHL compatible mobile device is connected to the projector, load the settings from **Load Memory** in the projector's **Settings** menu.
- ☛ **Settings > Geometry Correction > Arc Correction > Load Memory**

You can resize the image using the Wide and Tele buttons.

- 1** Turn on the projector and display an image.
- 2** Press the Wide button on the projector's control panel to enlarge the image size. Press the Tele button to reduce the image size.

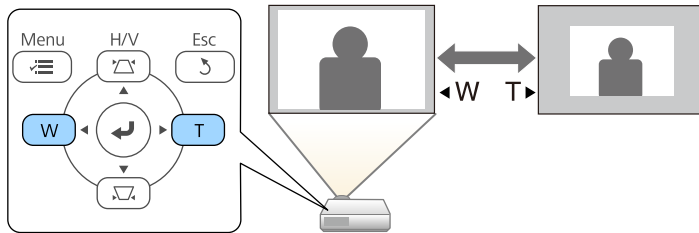

You can also adjust the **Zoom** setting in the projector's **Settings** menu.

You can use the Image Shift feature to adjust the image position without moving the projector.



This feature is not available if the Zoom option is set to the widest setting.

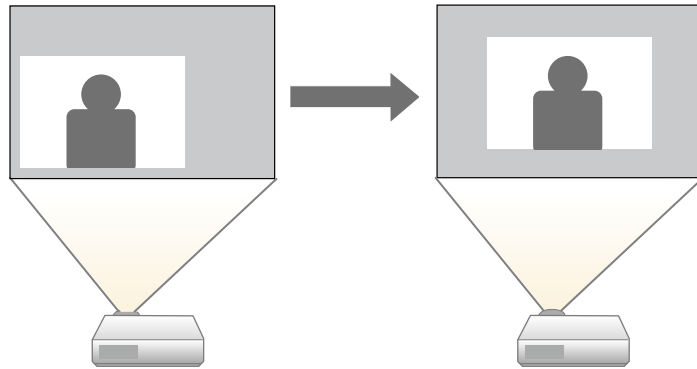

- 1** Turn on the projector and display an image.
- 2** Adjust the image size using the Wide and Tele buttons.
After you adjust the image size, the Image Shift screen is displayed automatically.

- 3** Use the arrow buttons on the projector or remote control to adjust the image position.

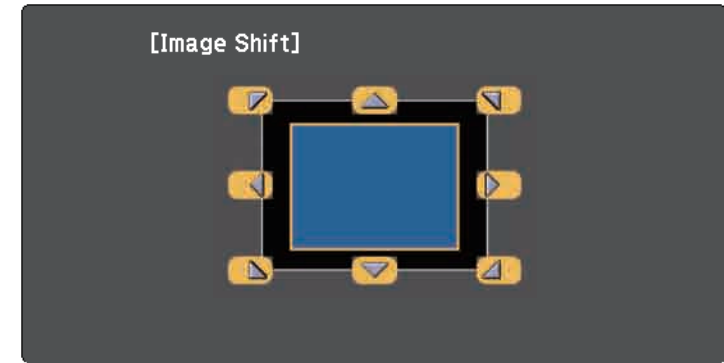

You can shift the image diagonally by pressing any pair of adjacent arrow buttons on the control panel or remote control.

- 4** Press the [Esc] button to close the adjustment screen.
The adjustment screen disappears if no operation is performed after approximately 10 seconds.



- The Image Shift setting is retained even if the projector is turned off. You need to re-adjust the position if you change the installation location or angle of the projector.
- You can also use the **Settings** menu to adjust the **Image Shift** setting.

When multiple image sources are connected to the projector, such as a computer and DVD player, you can switch from one image source to the other.

- 1** Make sure the connected image source you want to use is turned on.
- 2** For video image sources, insert a DVD or other video media and press play.
- 3** Do one of the following:
 - Press the [Source Search] button on the control panel, remote control, or control pad until you see the image from the source you want.

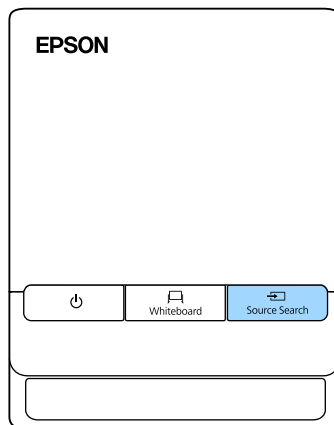
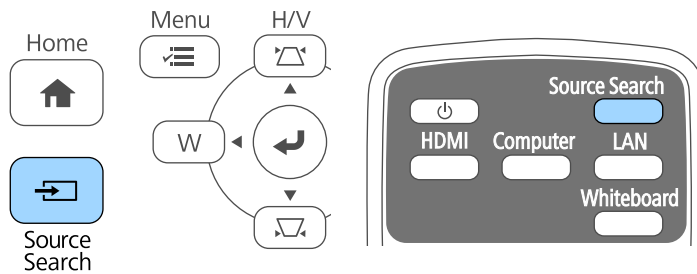

This screen is displayed when no image signal is detected. Check the cable connections between the projector and image source.

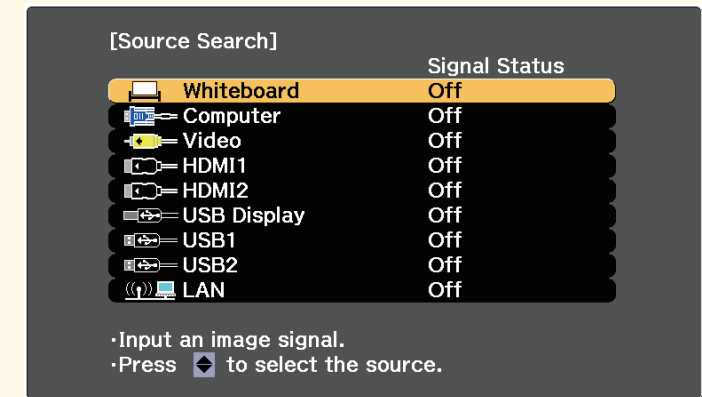

- Press the button for the source you want on the remote control. If there is more than one port for that source, press the button again to cycle through the sources.

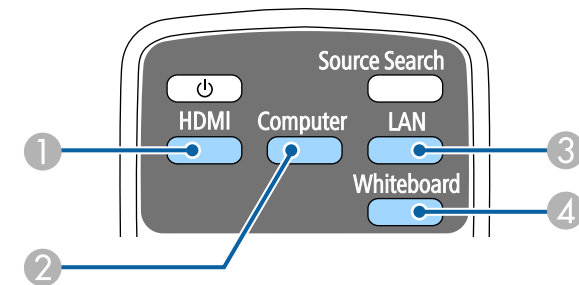

- 1 HDMI and MHL sources (HDMI1/MHL and HDMI2 ports)
- 2 Computer port source (Computer port)
- 3 Network source (LAN)
- 4 Whiteboard source (toggles between whiteboard mode and the previous input source)

- Press the [Home] button on the control panel or remote control.

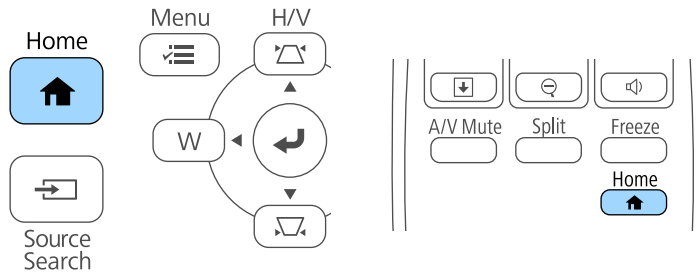

Then select the source you want to use from the screen displayed.

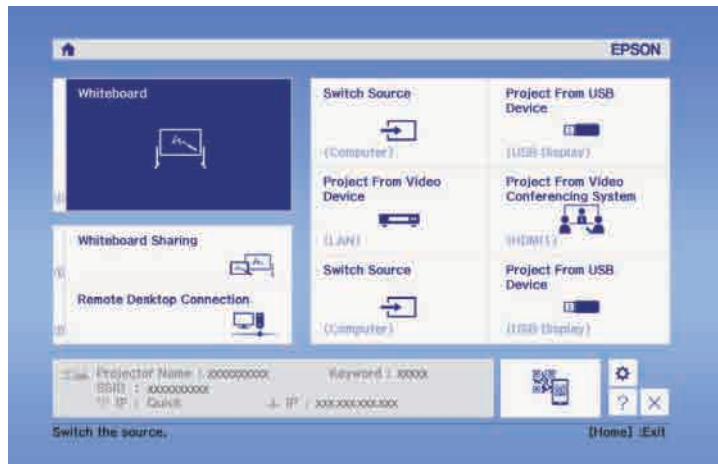

The projector can display images in different width-to-height ratios called aspect ratios. Normally, the input signal from your video source determines the image's aspect ratio. However, for certain images you can change the aspect ratio to fit your screen.

If you always want to use a particular aspect ratio for a certain video input source, you can select it using the projector's **Signal** menu.

► **Related Links**

- "Changing the Image Aspect Ratio" [p.70](#)
- "Available Image Aspect Ratios" [p.70](#)
- "Projected Image Appearance with Each Aspect Mode" [p.71](#)
- "Input Signal Settings - Signal Menu" [p.208](#)

Changing the Image Aspect Ratio

You can change the aspect ratio of the displayed image.

- 1 Turn on the projector and switch to the image source you want to use.
- 2 Press the [Aspect] button on the remote control.

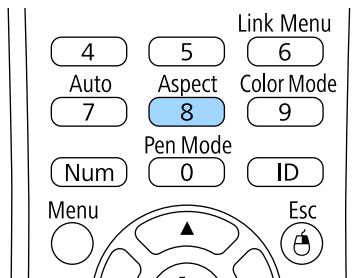

- 3 To cycle through the available aspect ratios for your input signal, press the [Aspect] button repeatedly.



To display images without black bars, set **Resolution** to **Wide** or **Normal** in the projector's **Signal** menu according to the computer's resolution.

► **Related Links**

- "Input Signal Settings - Signal Menu" [p.208](#)

Available Image Aspect Ratios

You can select the following image aspect ratios, depending on the input signal from your image source.



- Black bands and cropped images may project in certain aspect ratios, depending on the aspect ratio and resolution of your input signal.
- The **Auto** aspect ratio setting is available only for HDMI image sources.
- Note that using the aspect ratio function of the projector to reduce, enlarge, or split the projected image for commercial purposes or for public viewing may infringe upon the rights of the copyright holder of that image based on copyright law.

For projectors with a resolution of WUXGA (1920 × 1200)

Aspect mode	Description
Auto	Automatically sets the aspect ratio according to the input signal and the Resolution setting.
Normal	Displays images using the full projection area and maintains the aspect ratio of the image.
16:9	Converts the aspect ratio of the image to 16:9.
Full	Displays images using the full size of the projection area, but does not maintain the aspect ratio.
Zoom	Displays images using the full width of the projection area and maintains the aspect ratio of the image.















Aspect mode	Description
Native	Displays images as is (aspect ratio and resolution are maintained).

Projected Image Appearance with Each Aspect Mode

Black bands and cropped images may project in certain aspect ratios, depending on the aspect ratio and resolution of your input signal. See the following table to confirm the position of black bands and cropped images.

 The image for **Native** varies depending on the input signal.

For projectors with a resolution of WUXGA (1920 × 1200)

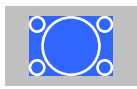
Aspect mode	Aspect ratio for input signals		
	16:10	16:9	4:3
Normal Auto			
16:9			
Full			
Zoom			
Native			

The projector offers different color modes to provide optimum brightness, contrast, and color for a variety of viewing environments and image types. You can select the mode designed to match your image and environment, or experiment with the available modes.

» **Related Links**

- "Changing the Color Mode" [p.72](#)
- "Available Color Modes" [p.72](#)
- "Setting Auto Iris" [p.72](#)

 You can also set the **Color Mode** setting in the projector's **Image** menu.

» **Related Links**

- "Image Quality Settings - Image Menu" [p.206](#)

Changing the Color Mode

You can change the projector's Color Mode using the remote control to optimize the image for your viewing environment.

- 1** Turn on the projector and switch to the image source you want to use.
- 2** Press the [Color Mode] button on the remote control to change the Color Mode.

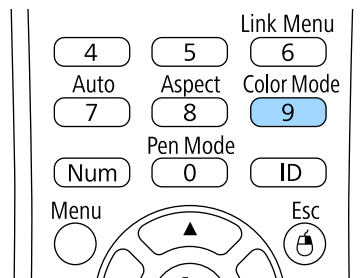

The name of the Color Mode appears briefly on the screen and then image appearance changes.

- 3** To cycle through all of the available color modes for your input signal, press the [Color Mode] button repeatedly.

Available Color Modes

You can set the projector to use these color modes, depending on the input source you are using:

Color mode	Description
Presentation	Best for color presentations and television images in a bright room, with vivid images in sharp contrast.
Dynamic	Best for projecting in a bright room. This is the brightest mode.
Cinema	Best for movies projected in a dark room with natural tone images.
sRGB	Best for still images projected in a bright room that conform to the sRGB color standard.
DICOM SIM	Best for projecting X-ray photographs and other medical images.

 The DICOM SIM color mode is for reference purposes only and should not be used to make medical diagnoses.

Setting Auto Iris

You can turn on Auto Iris to automatically optimize the image based on the brightness of the content.

This setting is available for **Dynamic** or **Cinema** color modes.

1 Turn on the projector and switch to the image source you want to use.

2 Press the [Menu] button on the control panel or remote control.

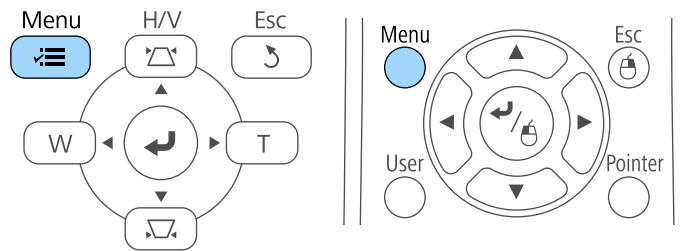

3 Select the **Image** menu and press [Enter].

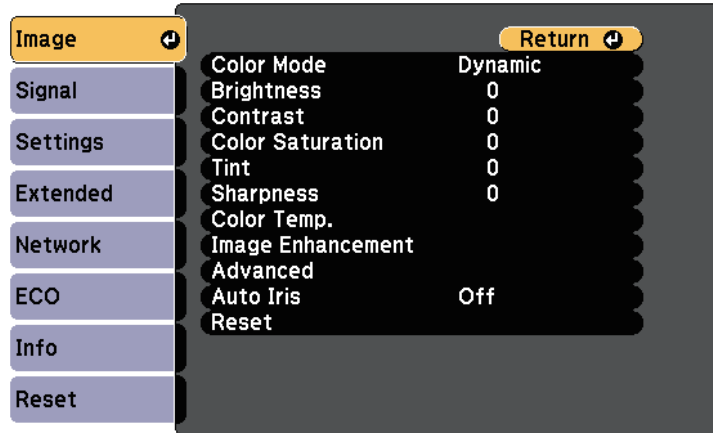

4 Select **Auto Iris** and press [Enter].

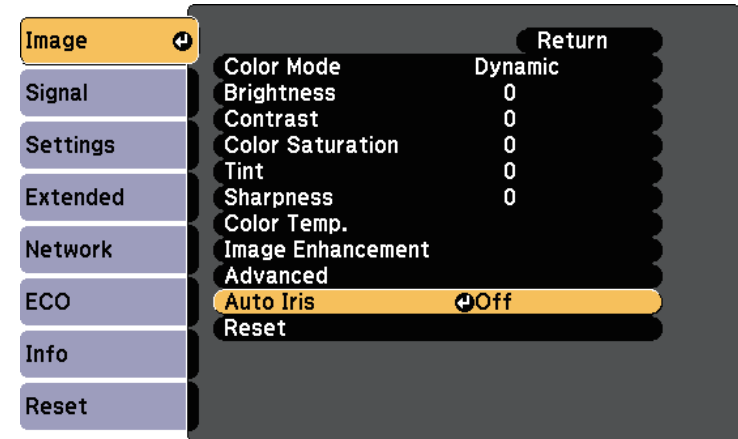

5 Choose one of the following options and press [Enter]:

- **High Speed** to adjust brightness as soon as the scene changes.
- **Normal** for standard brightness adjustment.

6 Press [Menu] or [Esc] to exit the menus.

You can fine-tune various aspects of how colors are displayed in your projected images.

► **Related Links**

- "Adjusting the Hue, Saturation, and Brightness" [p.74](#)
- "Adjusting the Gamma" [p.75](#)

Adjusting the Hue, Saturation, and Brightness

You can adjust the Hue, Saturation, and Brightness settings for individual image colors.

1 Turn on the projector and switch to the image source you want to use.

2 Press the [Menu] button on the control panel or remote control.

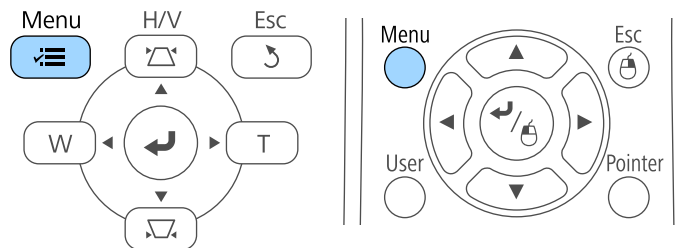

3 Select the **Image** menu and press [Enter].

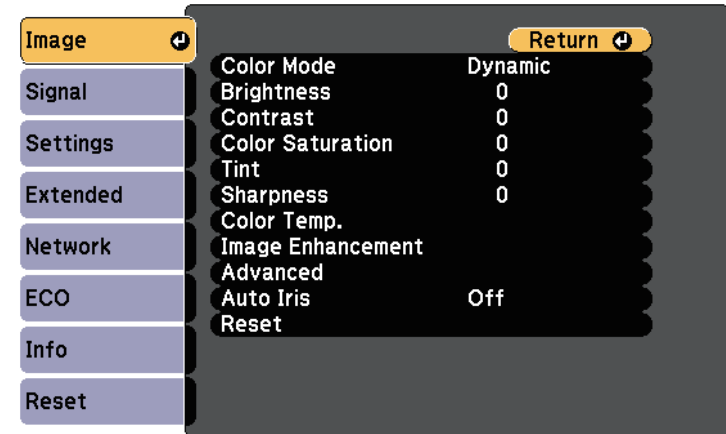

4 Select **Advanced** and press [Enter].

5 Select **RGBCMY** and press [Enter].

6 Select the color to adjust, and press [Enter].

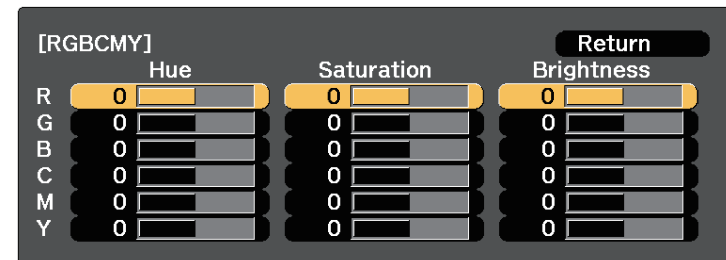

7 Do the following as necessary for each setting:

- To adjust the overall hue of the color, bluish - greenish - reddish, adjust the **Hue** setting.

- To adjust the overall vividness of the color, adjust the **Saturation** setting.
- To adjust the overall color brightness of the color, adjust the **Brightness** setting.

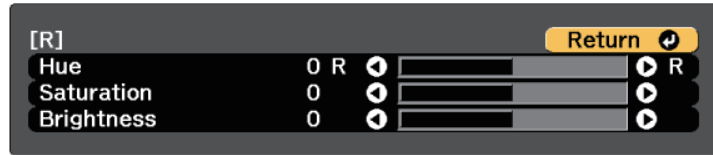

8 Press [Menu] or [Esc] to exit the menus.

Adjusting the Gamma

You can correct differences in projected image colors that occur between different image sources by adjusting the Gamma setting.

- 1** Turn on the projector and switch to the image source you want to use.
- 2** Press the [Menu] button on the control panel or remote control.

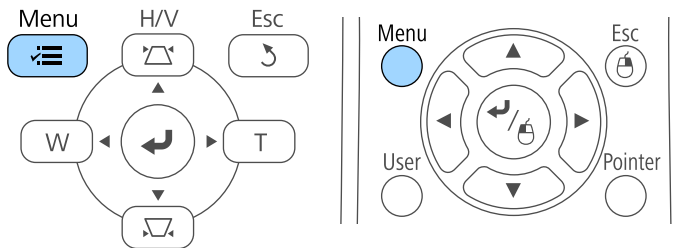

3 Select the **Image** menu and press [Enter].

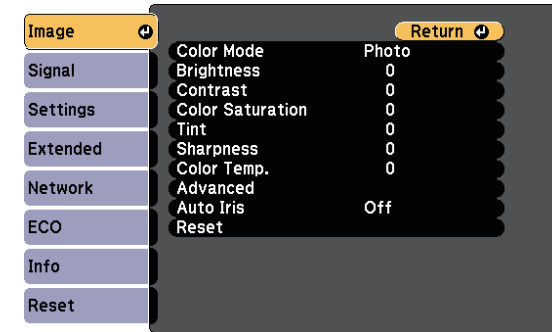

4 Select **Advanced** and press [Enter].

5 Select **Gamma** and press [Enter].

6 Select and adjust the correction value.

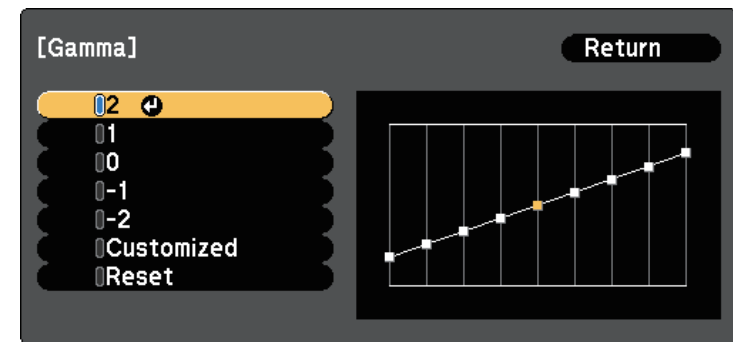

When you select a smaller value, you can reduce the overall brightness of the image to make the image sharper. When you select a larger value,

the dark areas of images become brighter, but the color saturation for lighter areas may become weaker.

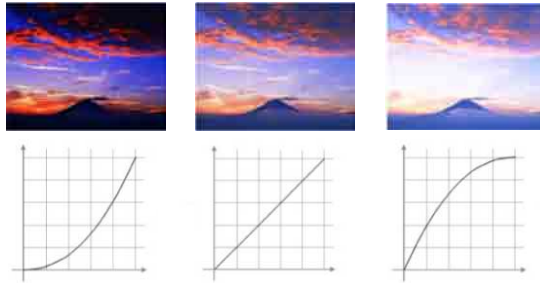

- If you selected **DICOM SIM** as the **Color Mode** setting in the projector's **Image** menu, select the adjustment value according to the projection size.
- If the projection size is 80 inches or less, select a small value.
- If the projection size is 80 inches or more, select a large value.
- Medical images may not be reproduced correctly depending on your settings and screen specifications.

7 Press [Menu] or [Esc] to exit the menus.

The volume buttons control the projector's internal speaker system.

You can also control the volume of any external speakers you connected to the projector.

You must adjust the volume separately for each connected input source.

- 1** Turn on the projector and start a presentation.
- 2** To lower or raise the volume, press the [Volume] buttons on the remote control as shown.

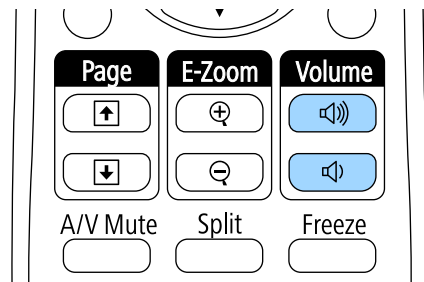

A volume gauge appears on the screen.

- 3** To set the volume to a specific level for an input source, select **Volume** in the projector's **Settings** menu.

Caution

Do not start a presentation at a high volume setting. Sudden loud noises may cause hearing loss.

Always lower the volume before powering off, so that you can power on and then gradually increase the volume.

» **Related Links**

- "Projector Feature Settings - Settings Menu" [p.210](#)

Using the Interactive Features

Follow the instructions in these sections to use the interactive features.

► Related Links

- "Interactive Feature Modes" [p.79](#)
- "Preparing Before Using Interactive Features" [p.80](#)
- "Whiteboard Screens (Whiteboard Mode)" [p.91](#)
- "Draw on the Projected Image Using Annotation Mode" [p.115](#)
- "Control Computer Features from a Projected Screen (Computer Interactive Mode)" [p.120](#)
- "Switching the Interactive Mode" [p.125](#)
- "Selecting Network Device Display" [p.126](#)
- "Connecting to a Remote Computer" [p.128](#)
- "Using the Interactive Features over a Network" [p.131](#)
- "Windows Pen Input and Ink Tools" [p.132](#)
- "Interactive Features when Projecting Two Images Simultaneously" [p.134](#)
- "Interactive Features when Projecting with Two Projectors" [p.137](#)

You can perform the following operations with the interactive features.

-  • Touch operations with your finger are only available for EB-1450Ui.

- In whiteboard mode, you can use interactive pens or your finger to write on the projected "whiteboard".

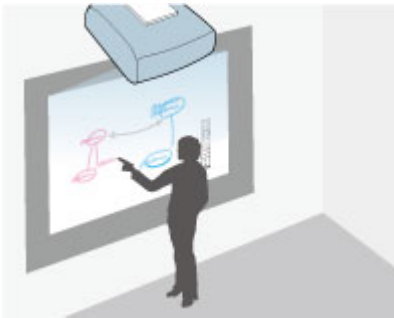

You do not need to use a computer or install any additional software to use the built-in whiteboard drawing feature. This is useful in meetings as a substitute for a whiteboard.

You can share the drawing contents you create with other projectors or tablets, save it as a PDF or PNG file, and print it or send it as an email.

- In annotation mode, you can use interactive pens or your finger to add notes to content projected from a computer, tablet, document camera, or other source.



This helps you emphasize projected information or include additional notes for more effective lessons or presentations.

You can capture your annotated pages, then save or print them.

- In computer interactive mode, you can use interactive pens or your finger as you would use a mouse. This allows you to navigate, select, and scroll through content projected from your computer.



-  You can also use the Easy Interactive Tools software to provide additional interactive features, such as saving and printing your annotations. See the *Easy Interactive Tools Operation Guide* built into the software for instructions.

► Related Links

- "Draw on the Projected Image Using Annotation Mode" [p.115](#)
- "Whiteboard Screens (Whiteboard Mode)" [p.91](#)
- "Control Computer Features from a Projected Screen (Computer Interactive Mode)" [p.120](#)

This section provides safety instructions on setting up and using the interactive pens or performing touch operations with your finger. Read these instructions before using the interactive features.

► Related Links

- "Safety Instructions for Interactive Features" p.80
- "Using the Interactive Pens" p.80
- "Using Interactive Touch Operations with Your Finger" p.85

Safety Instructions for Interactive Features

The interactive feature operates by infrared communication. Note the following important points when using this feature.

- Make sure there is no strong light or sunlight shining on the interactive pen receiver and the projection screen.
- If there is any dust stuck to the interactive pen receiver, it could interfere with infrared communication and you may not be able to use the features normally. Clean the receiver if it is dirty.
- Do not put paint or any stickers on the cover of the interactive pen receiver.
- Do not use an infrared remote control or infrared microphone in the same room because the interactive pen may malfunction.
- Do not use devices that generate powerful noise, such as rotary devices or transformers, near the projector. You may not be able to operate the interactive features.

► Related Links

- "Maintaining the Projector" p.241

Using the Interactive Pens

Your projector comes with a blue pen and an orange pen, identified by the color on the end of the pen. You can use either pen, or both at the same time (one of each color).

Make sure the pen batteries are installed.

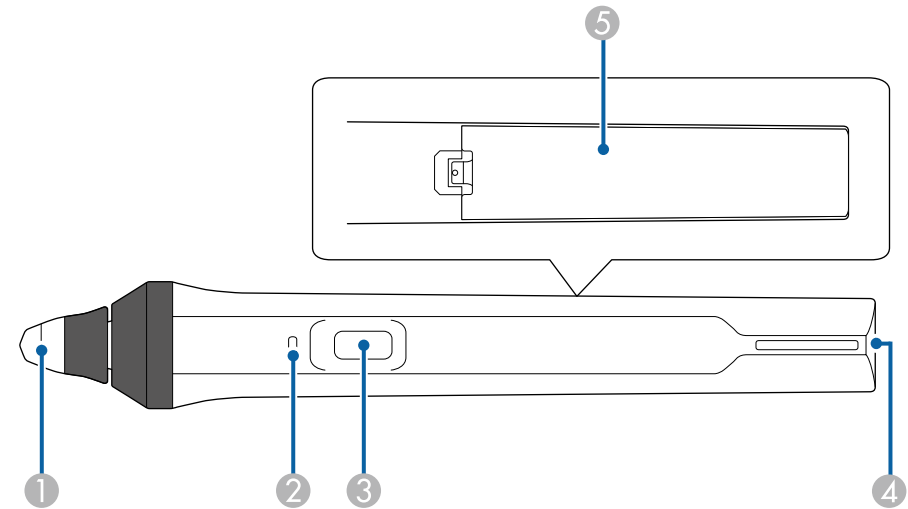

- 1 Pen tip
- 2 Battery indicator
- 3 Button
- 4 Strap attachment point
- 5 Battery cover

Hold the pen to turn it on.

When you are finished using the pen, leave the pen as it is far from the projection screen.

Attention

- Do not use interactive pens with wet hands or in locations where the pens may get wet. The interactive pens are not waterproof.
- Keep the projector and projection screen out of direct sunlight, or the interactive features may not work.



- Pens turn off automatically after 15 seconds when they are placed on. Hold the pen to turn it back on.
- For best performance, hold the pen perpendicular to the board, as shown below. Do not cover the black band near the tip of the pen.

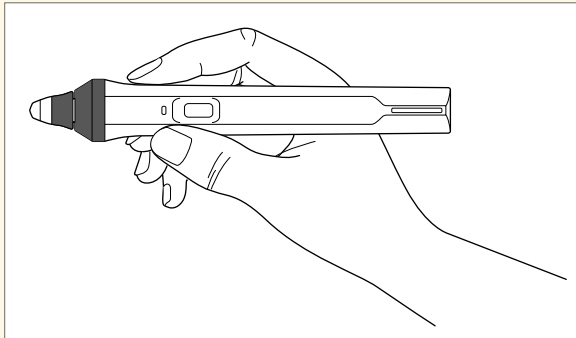

You can do the following using the pen:

- Write or draw on the projection surface in whiteboard mode and annotation mode.

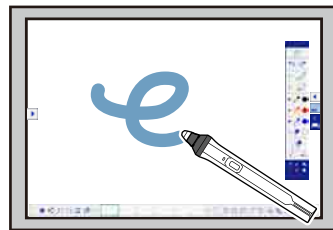
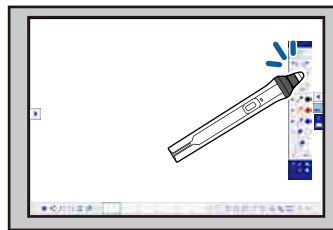

- To select a projected item, such as an icon, tap the projection surface with the pen tip.
- To draw on the projected screen, tap the projection surface with the pen and drag it as necessary.
- To move the projected pointer, hover over the surface without touching it.

- To switch the pen operation from a drawing tool to an eraser or other functions selected in the projector's **Extended** menu, press the button on the side.

☞ **Extended** > **Easy Interactive Function** > **General** > **Advanced** > **Pen Button Function**

- Use the pen as a mouse in computer interactive mode.

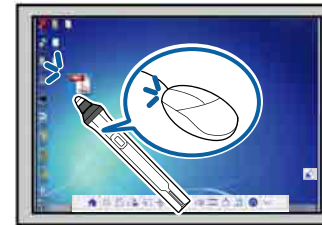

- To left-click, tap the board with the pen tip.
- To double-click, tap twice with the pen tip.
- To right-click, press the button on the side.
- To click and drag, tap and drag with the pen.
- To move the cursor, hover over the board without touching it.



- If you do not want to use the hovering feature, you can turn it off using the **Hovering** setting in the projector's **Extended** menu.

☞ **Extended** > **Easy Interactive Function** > **Hovering**

- To make a long press of the pen act as a right-click, select the following settings in the projector's **Extended** menu.

- Set the **Enable Right Click** setting to **On**.

☞ **Extended** > **Easy Interactive Function** > **Enable Right Click**

» Related Links

- "Pen Calibration" [p.82](#)
- "Calibrating Automatically" [p.82](#)
- "Calibrating Manually" [p.83](#)

- "Projector Parts - Interactive Pens" p.20

Pen Calibration

Calibration coordinates the positioning of the pen with the location of your cursor. You only need to calibrate the first time you use your projector.

You can use **Auto Calibration** to calibrate the system, but **Manual Calibration** is also available for finer adjustments or if **Auto Calibration** failed.



- Move any pen you are not using away from the projection screen while calibrating the system.
- Make sure to perform the manual calibration when you project images on a curved surface.
- Calibrate the system again if you notice any discrepancy in positioning after doing any of the following:
 - Performing Geometry Correction
 - Adjusting the image size
 - Using the Image Shift feature
 - Changing the projector position
- The calibration results remain until you recalibrate.

Calibrating Automatically

You need to calibrate the first time you use your projector, and you do not need the pens or a computer for **Auto Calibration**.



You can also start **Auto Calibration** by pressing the [User] button on the remote control.

- 1 Press the [Menu] button, select the **Extended** menu, and press the [Enter] button.

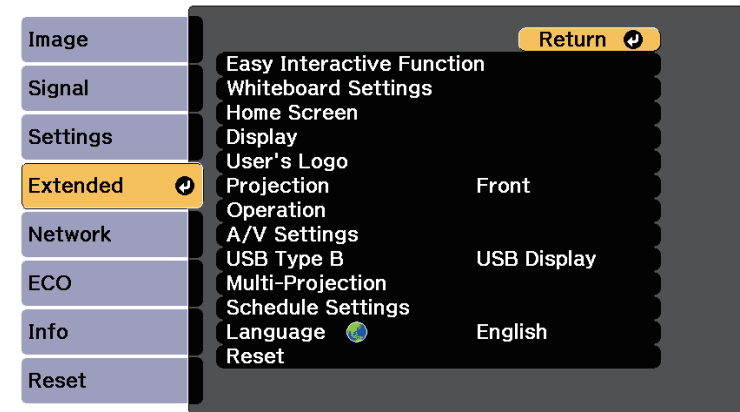

- 2 Select the **Easy Interactive Function** setting and press the [Enter] button.

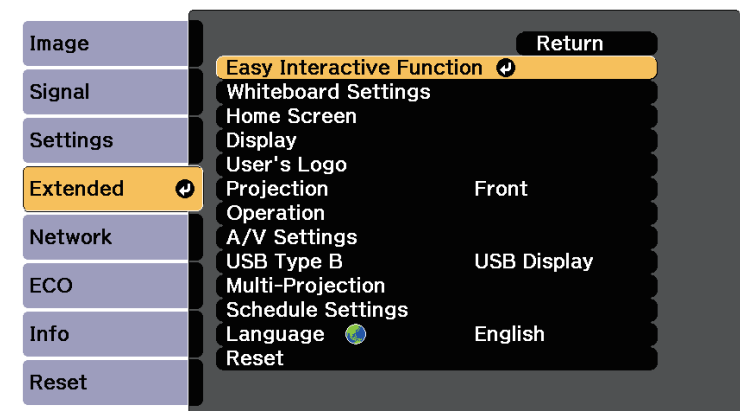

- 3 Select **Auto Calibration** and press the [Enter] button.

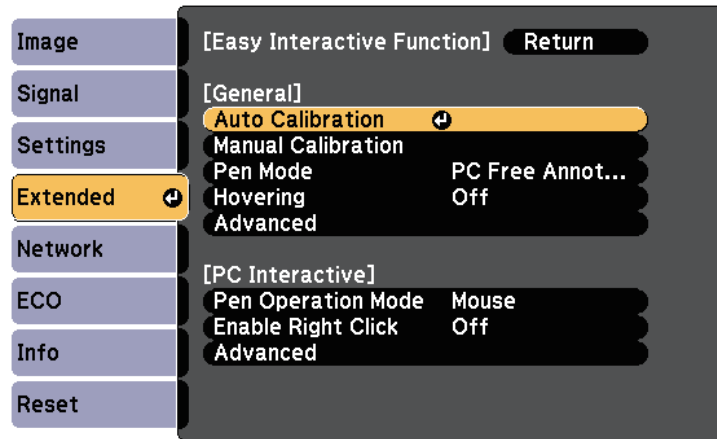

A pattern appears then disappears, and the system is calibrated. If you see a message that calibration failed, you need to calibrate manually.

The cursor location and pen position should match after calibration. If not, you may need to calibrate manually.

Calibrating Manually

If the cursor location and pen position do not match after auto calibration, you can calibrate manually.

Make sure to perform the manual calibration when you project images on a curved surface.

- 1 Press the [Menu] button, select the **Extended** menu, and press the [Enter] button.

The following screen appears.

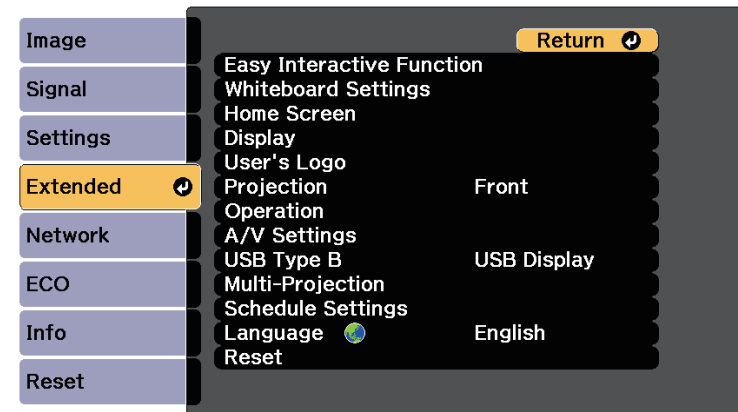
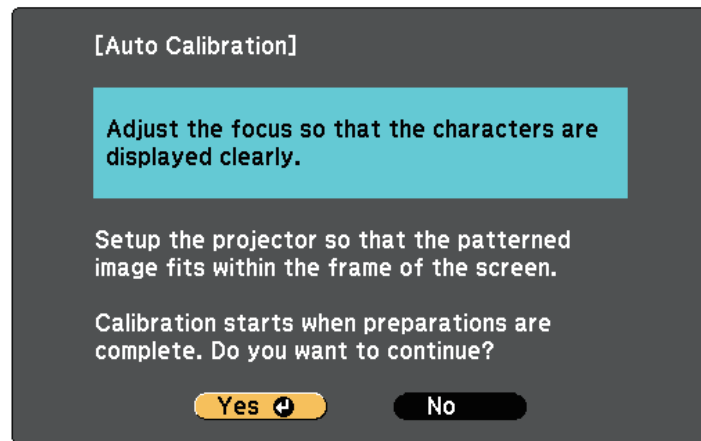

- 2 Select the **Easy Interactive Function** setting and press the [Enter] button.

- 4 Adjust the focus, if necessary, by opening the air filter cover on the side of the projector and sliding the focus lever.

- 5 Select **Yes** and press the [Enter] button.

- 3** Select **Manual Calibration** and press the [Enter] button.

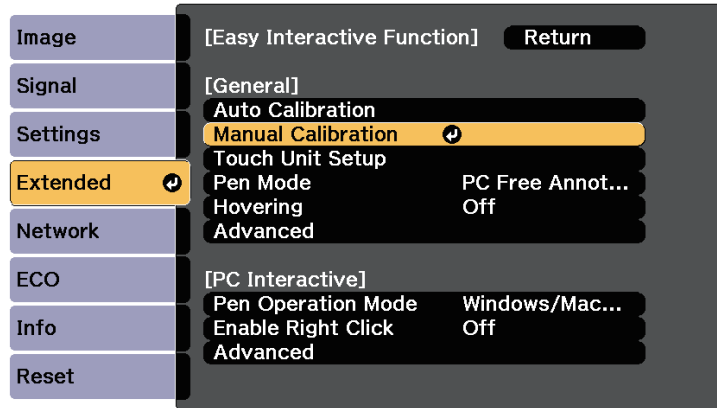

The following screen appears.

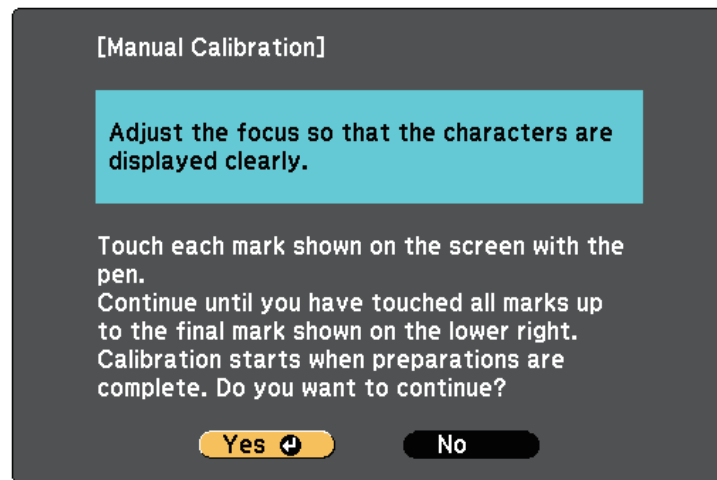

- 4** Adjust the focus, if necessary, by opening the air filter cover on the side of the projector and sliding the focus lever.

- 5** Select **Yes** and press the [Enter] button.

A flashing green circle appears in the upper left corner of your projected image.

- 6** Touch the center of the circle with the tip of the pen.
The circle disappears, and you see another circle below the first one.

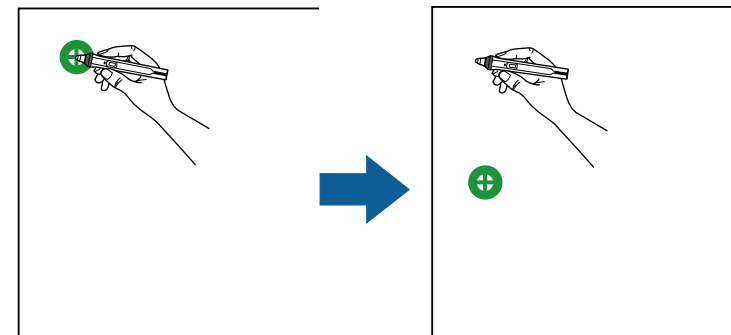

For the most accurate calibration, make sure you touch the center of the circle.

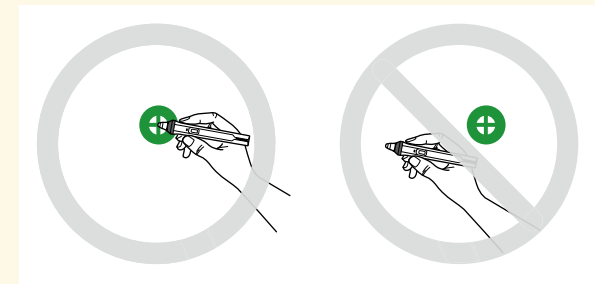

- 7** Touch the center of the next circle, then repeat. When you get to the bottom of the column, the next circle appears at the top of a new column.

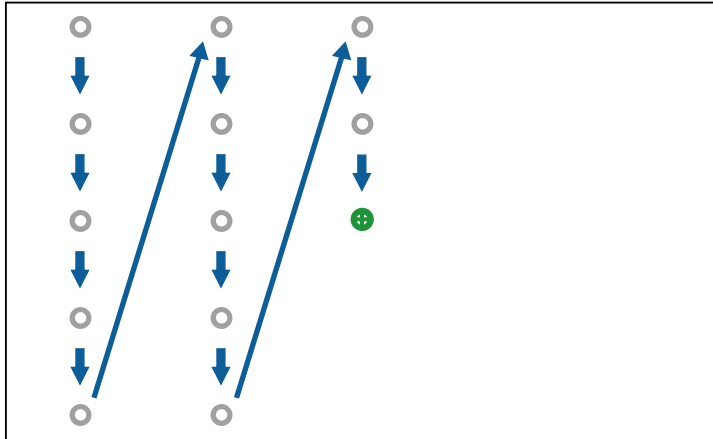

- Make sure you are not blocking the signal between the pen and the interactive receiver.
- If you make a mistake, press the [Esc] button on the remote control to go back to the previous circle.
- To cancel the calibration process, press and hold the [Esc] button for 2 seconds.

- 8** Continue until all of the circles disappear.

Using Interactive Touch Operations with Your Finger

You can use your finger to interact with the projected screen, just as you would use an interactive pen (EB-1450Ui). You can use either a pen or your finger, or use both at the same time.

The projector recognizes up to six touch points in computer interactive mode. When performing touch operations with your finger, you can use two fingers in annotation and whiteboard modes.

Do the following before using your finger for touch operations:

- Install the Touch Unit
- Calibrate the system manually for the pen
- Perform angle adjustment for the Touch Unit
- Calibrate the system for touch operations

See the *Installation Guide* for details.

The Touch Unit turns on and is ready for touch operation with your finger when you turn on the projector and the indicator lights up in blue.

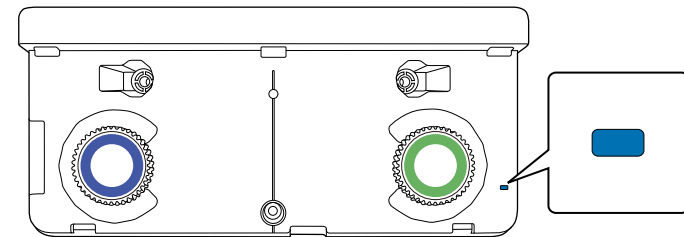



- Check the following if the Touch Unit does not turn on.
 - The **Power** setting in the **Touch Unit Setup** menu is set to **On**.
➤ **Extended > Easy Interactive Function > Touch Unit Setup > Power**
 - The Touch Unit is connected to the projector's TCH port with a Touch Unit connection cable.
- Positioning discrepancies may occur depending on the angle of your finger or the direction you point.
- Touch operations with your finger may not work properly with long or artificial nails, or with your fingers wrapped in bandages.
- Touch operations may not be recognized correctly if your fingers or the pens are too close together or crossed.
- If clothing or another part of your body comes close to or touches the screen, the touch operations may work incorrectly.
- If you touch the screen with your free hand during touch operations, the touch operations may work incorrectly.

You can perform the following touch operations with your finger:

- Use your finger as a mouse in computer interactive mode.



- To left-click, tap the board with your finger.
- To double-click, tap twice with your finger.
- To click and drag, press on and drag an item with your finger.



- If your device supports these functions, you can also do the following:
 - To zoom in or out, touch an item using two fingers, and either move your fingers away from each other (stretch to zoom in) or toward each other (pinch to zoom out).
 - To rotate the image, touch the image using two fingers and then rotate your hand.
 - To scroll up or down the page, or move backward or forward in a browser window, use gestures such as flicks.
- You can only use one tool with one finger at a time.

- Write or draw on the projection surface in annotation mode and whiteboard mode.

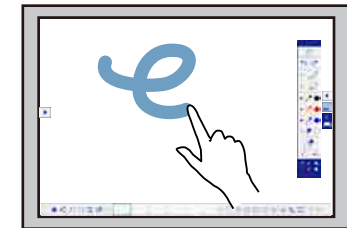
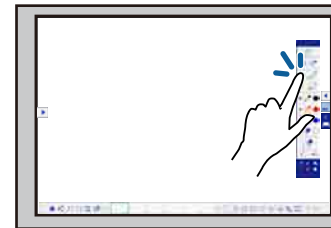

- To select a projected item, such as an icon, tap the projection surface with your finger.
- To draw on the projected screen for the first time after turning on the projector, select a pen in the toolbar and tap the projection surface with your finger. If you do not do this, your finger works as an eraser the first time you use touch operations.
- To zoom in or out, touch an item using two fingers, and either move your fingers away from each other (stretch to zoom in) or toward each other (pinch to zoom out).
- To rotate the image in whiteboard mode, touch the image using two fingers and then rotate your hand.

» Related Links

- "Calibrating for Touch Operations with Your Finger" [p.87](#)

- "Safety Instructions for Interactive Touch Operations" p.89
- "Laser Warning Labels" p.90

Calibrating for Touch Operations with Your Finger

Calibration coordinates the positioning of your finger with the location of your cursor (EB-1450Ui). If the cursor location and your finger position do not match, you need to calibrate again.



- The positioning of your finger is usually adjusted when the Touch Unit is installed. See the *Installation Guide* for details.
- Make sure you have calibrated the system for the pen using **Auto Calibration** or **Manual Calibration** before calibrating for touch operations with your finger.
- Calibrate for touch operations with your finger again if you notice any discrepancy in positioning after doing any of the following:
 - Calibrating the system for use with the pen (automatically or manually)
 - Performing angle adjustments for the Touch Unit
 - Performing Geometry Correction
 - Adjusting the image size
 - Using the Image Shift feature
 - Changing the projector position

- 1 Press the [Menu] button, select the **Extended** menu, and then press [Enter].

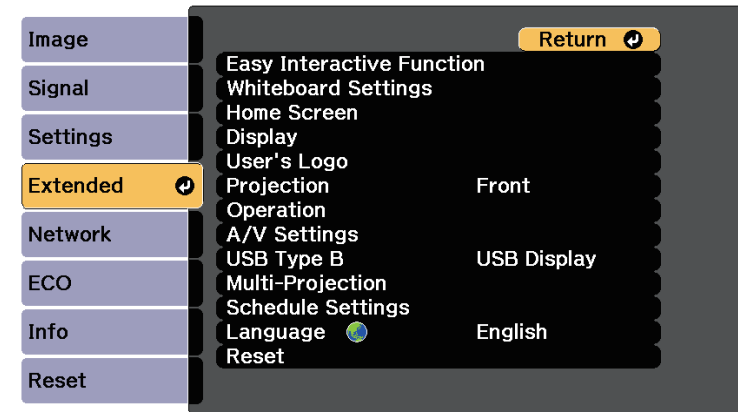

- 2 Select the **Easy Interactive Function** setting and press [Enter].

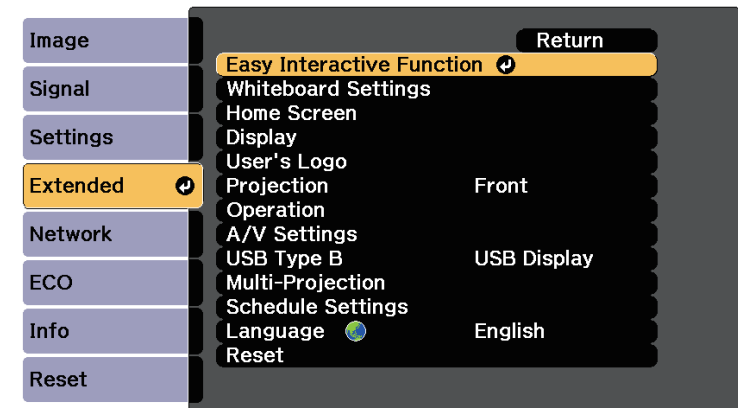

- 3** Select **Touch Unit Setup** and press the [Enter] button.

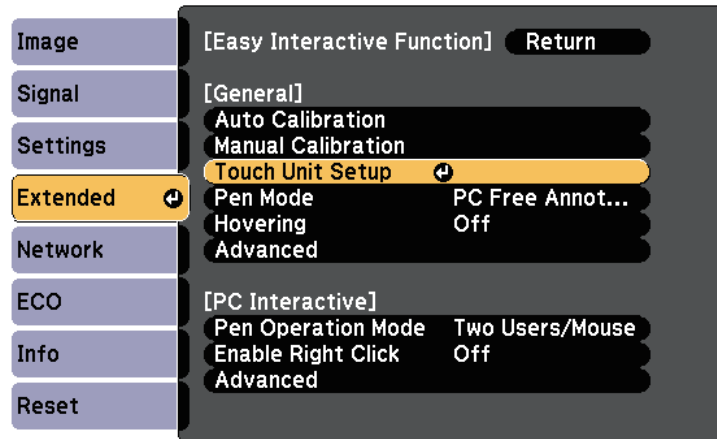

The following screen appears.

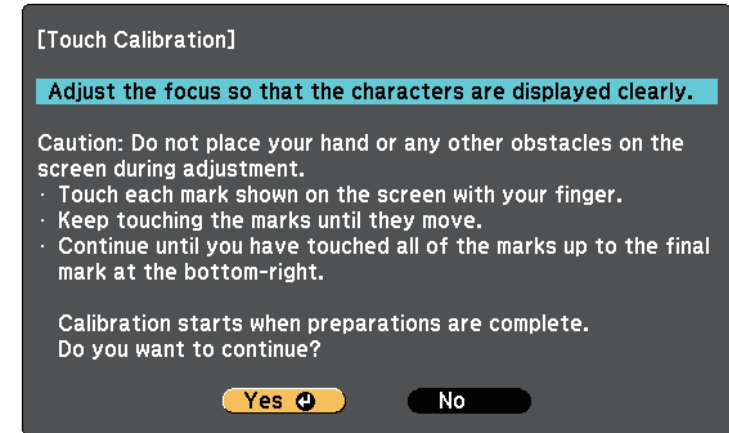

- 4** Select **Touch Calibration** and press the [Enter] button.

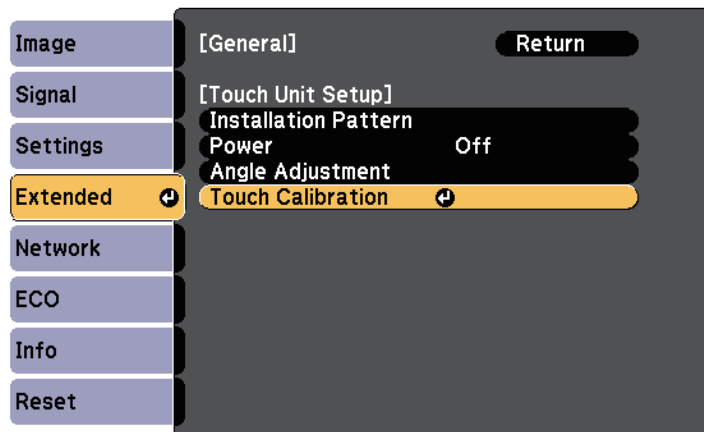

- 5** Adjust the focus, if necessary, by opening the air filter cover on the side of the projector and sliding the focus lever.

- 6** Select **Yes** and press the [Enter] button.

A flashing green circle appears in the upper left corner of your projected image.

- 7** Touch and hold the center of the circle with your finger until the circle disappears and the another circle appears, then release it.

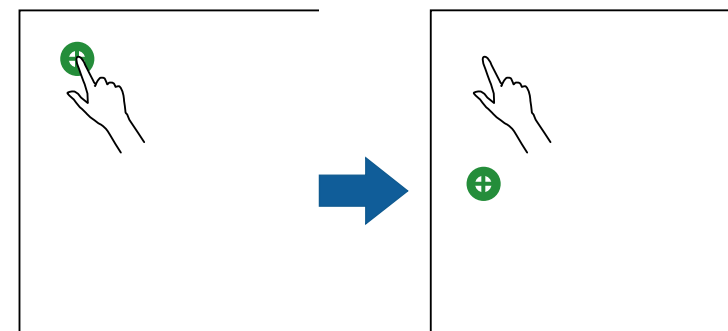



- For the most accurate calibration, make sure you touch the center of the circle.



- Do not touch the circle with anything except the tip of your finger.

8 Touch the center of the next circle with your finger, then repeat. When you get to the bottom of the column, the next circle appears at the top of a new column.

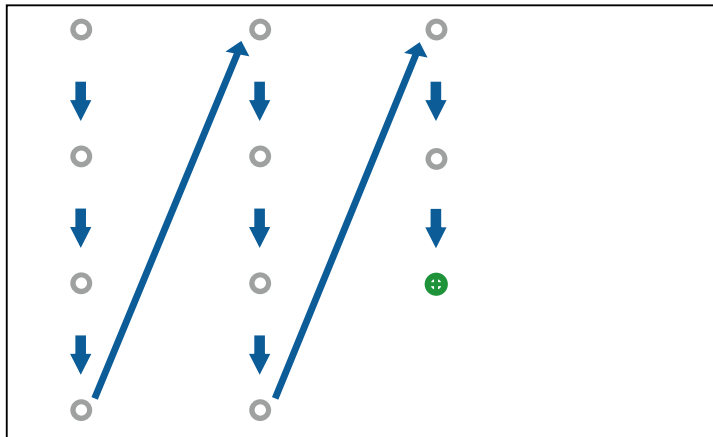

- Make sure you are not blocking the signal between your finger and the interactive receiver.
- If you touch the wrong position, press the [Esc] button on the remote control or control panel.
- To cancel touch calibration, hold down the [Esc] button for two seconds.

9 Continue until all of the circles disappear.

Safety Instructions for Interactive Touch Operations

Touch operation with your finger is enabled by installing the Touch Unit with a built-in high-power laser (EB-1450Ui).

The laser radiates from the laser diffusion ports on rear of the Touch Unit:

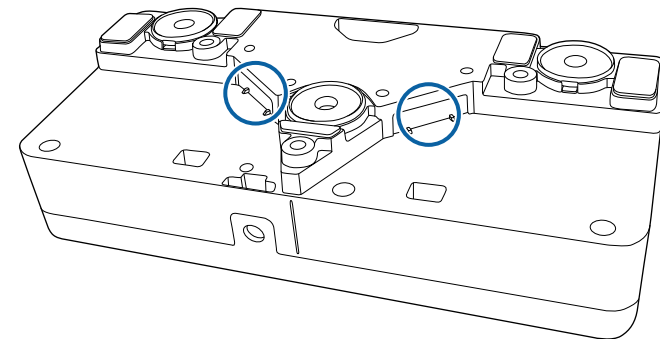

Note the following important points when performing touch operations.

Warning

- Never open any cases on the projector or the Touch Unit. Never attempt to disassemble or modify the projector or the Touch Unit. Electrical voltages inside the projector can cause severe injury.
- Unplug the projector from the outlet and refer all repairs to qualified service personnel if any problems occur with the projector or the Touch Unit. Continued use of the Touch Unit may result in fire or accidents, and can also damage your eyes.

- CLASS 1 LASER PRODUCT
- WARNING: Never open any covers on this unit. Laser product inside.
- WARNING:
 - CAUTION: CLASS 3B INVISIBLE LASER RADIATION WHEN OPEN
 - AVOID EXPOSURE TO THE BEAM

Laser Warning Labels

The Touch Unit is a Class 1 laser product that complies with IEC/EN60825-1:2007.

The labels indicating the Class 1 laser product and warnings are placed in the following places on the Touch Unit:

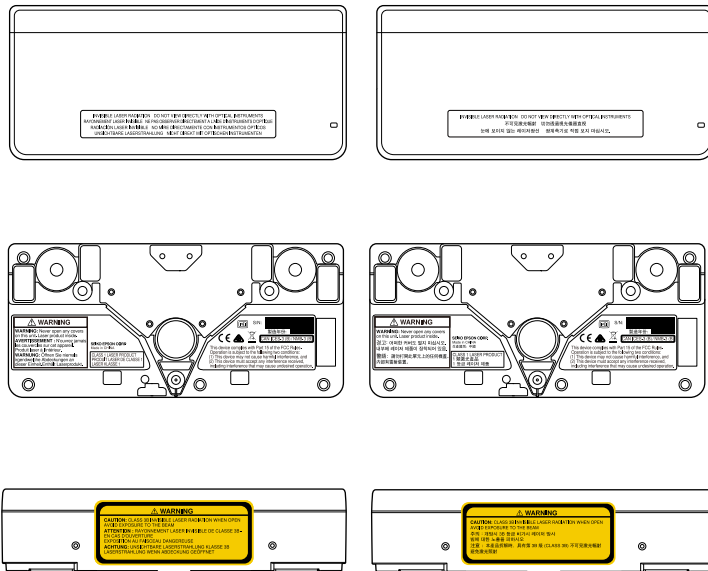

The labels indicate the following:

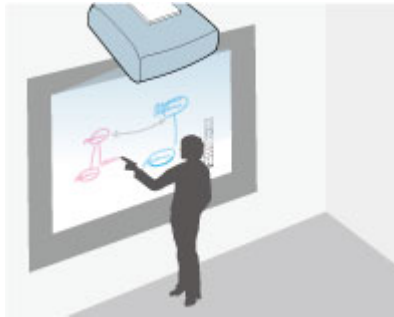

You can use your projector to project a whiteboard image onto a plain surface. You can then use the interactive pens or your finger (EB-1450Ui) to draw letters and shapes on the image as if it were a whiteboard. This is useful in locations that do not have a whiteboard.



In whiteboard mode, you can also use both pens, or both pens and your finger, at the same time.

» Related Links

- "Starting Whiteboard Mode" [p.91](#)
- "Whiteboard Mode Toolbar" [p.92](#)
- "Whiteboard Mode Bottom Toolbar" [p.95](#)
- "Projecting Scanned Images in Whiteboard Mode" [p.97](#)
- "Compatible File Types for Opening in Whiteboard Mode" [p.98](#)
- "Sharing Drawings Created in Whiteboard Mode" [p.99](#)
- "Whiteboard Sharing with Other Devices" [p.105](#)

Starting Whiteboard Mode

You can draw on the whiteboard screen using the whiteboard mode toolbar and bottom toolbar.

- 1** Press the [Whiteboard] button on the control pad or the remote control.

You see the whiteboard screen and toolbar, for example:

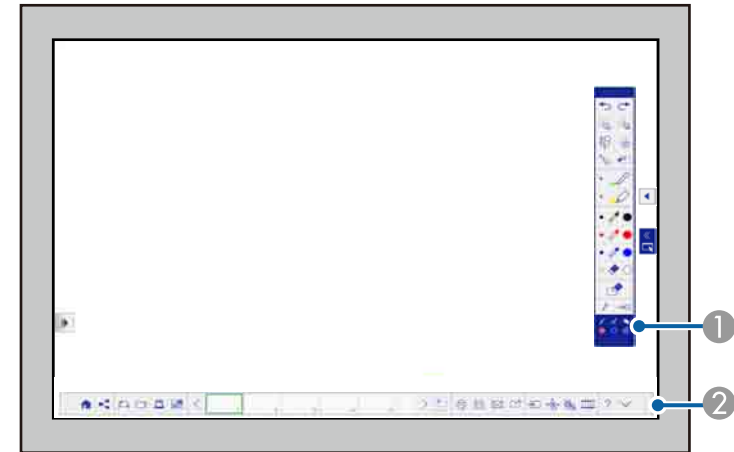



- 1** Whiteboard mode drawing toolbar
- 2** Whiteboard mode bottom toolbar

When the toolbars are displayed, you can write on the projected screen using the interactive pen or your finger (EB-1450Ui).

The drawing toolbar provides drawing tools such as a pen and shapes.

The bottom toolbar provides additional tools, such as tools for controlling the projector or saving the projected screen.



- You can move the toolbar by tapping and dragging the bar at the top or bottom of the toolbar.
- You can move the bottom toolbar right and left by tapping and dragging the right or left end of the bar.
- You can also start whiteboard mode using one of the following methods.
 - In annotation mode, tap and drag the  or  whiteboard mode tab to the edge of the screen.
 - Select the  icon on the bottom toolbar and then select **Whiteboard**.
 - Select **Whiteboard** as the Web Remote source setting.
 - Select **Whiteboard** on the Home screen.
- Any drawings that you create in whiteboard mode are retained if you change to annotation mode or other image sources.
- If you press the [Whiteboard] button on the control pad or remote control while using whiteboard mode, the image source switches to the source you last used before starting whiteboard mode.

» Related Links

- "Safety Instructions for Whiteboard Mode" [p.92](#)

Safety Instructions for Whiteboard Mode

Note the following important points when using this feature.

- All drawing data is cleared when the projector is turned off. Set the **Auto Delete Saved Data** setting to **Retain** in the projector's **Extended** menu to restore the drawing when the projector is turned on again.
 - ☛ **Extended** > **Whiteboard Settings** > **Policy** > **Auto Delete Saved Data**
- On the projector's **Whiteboard Settings** menu, you can make settings to prevent data leakage. Make settings if necessary.
 - ☛ **Extended** > **Whiteboard Settings**
- When the projector is shared, lent, given to a third party, or disposed of, check that there is no important data such as personal or confidential





information saved in the internal storage, and if there is, make sure you delete the information.



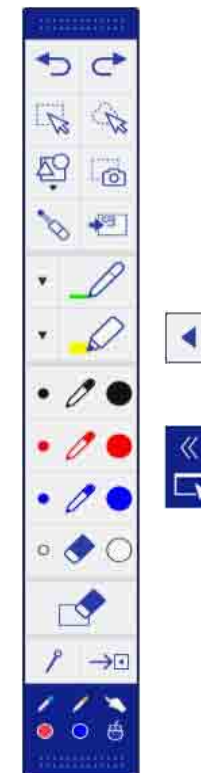

- Users are responsible for managing this data. Epson takes no responsibility for direct or indirect damage caused by loss, damage, or disclosure of the user's data or data for third parties through the use of this projector. Make sure you understand these points before use.







Whiteboard Mode Toolbar











The whiteboard mode toolbar lets you draw and write on the projected screen. The whiteboard mode toolbar is shown in the following illustration.























	Shows or hides the toolbar. You can move the tabs up and down.
	<p>Splits the screen and displays the annotation mode screen. You can move the tabs up and down.</p> <ul style="list-style-type: none"> To enlarge one image while reducing the other image during split screen projection, tap and drag the  tab. To switch to annotation mode, tap and drag the tab to the edge of the screen.
	Undoes the last operation. You can undo up to 15 operations per page.
	Redoes the last undo.

	<p>Selects all objects and images in a rectangular area. Specify the area by dragging on the projection surface. You can also tap an object or image to select it.</p> <ul style="list-style-type: none"> Tap an area in which there are no objects or images to cancel the current selection. Select the  icon at the bottom right of the selected object or image to perform the following operations: <ul style="list-style-type: none"> Cut Copy Paste Group/Ungroup (available when selecting multiple objects and images) Auto Crop: Deletes the black frame around the image (available when selecting a single image) Delete <p>To paste the cut or copied object or image, tap the screen, select the  icon, and select Paste.</p> <ul style="list-style-type: none"> Drag the edge of the area to enlarge or reduce the object or image. Drag the side of the area to crop the selected image (available when selecting a single image). Drag  at the top of the area to rotate the selected object or image.
---	---

	<p>Selects all objects and images in a freehand area. Specify the area by drawing on the projection surface. You can also tap an object or image to select it.</p> <ul style="list-style-type: none"> • Tap an area in which there are no objects or images to cancel the current selection. • Select the  icon at the bottom right of the selected object or image to perform the following operations: <ul style="list-style-type: none"> • Cut • Copy • Paste • Group/Ungroup (available when selecting multiple objects and images) • Auto Crop: Deletes the black frame around the image (available when selecting a single image) • Delete <p>To paste the cut or copied object or image, tap the screen, select the  icon, and select Paste.</p> <ul style="list-style-type: none"> • Drag the edge of the area to enlarge or reduce the object or image. • Drag the side of the area to crop the selected image (available when selecting a single image). • Drag  at the top of the area to rotate the selected object or image.
	<p>Inserts a circle, square, triangle, or other shape. You can select the line width and color.</p>
	<p>Captures the selected area as an image and pastes the captured image. Tap and drag on the projection surface to select the area, and then lift the pen to paste the image.</p>

	<p>Turns the pen into a draggable pointer and displays it on the whiteboard screen and all connected devices. You cannot operate the pointer at the same time on multiple devices.</p> <div data-bbox="1388 359 2094 486" style="border: 1px solid black; padding: 5px; background-color: #ffffcc;"> <p> The pointer feature differs from the projector's pointer feature. You cannot change the form of the pointer or control it with the remote control.</p> </div>
	<p>Inserts an image from the USB storage device or a network folder. You can select files that meet the following specifications:</p> <ul style="list-style-type: none"> • Format: PNG, JPEG • Resolution: 2048 × 2048 maximum • Pixel Count: 2 million or less <p>Images larger than a page are reduced to fit.</p>
	<p>Writes or draws free-form lines with custom pen. Select the  icon to change custom pen color and width.</p>
	<p>Writes or draws free-form lines with a transparent highlighter pen. Select the  icon to change highlighter pen color and width.</p>
	<p>Black pen (fine point on left, thick on right).</p>
	<p>Red pen (fine point on left, thick on right).</p>
	<p>Blue pen (fine point on left, thick on right).</p>

	<p>Eraser (thin width on left, thick on right).</p> <div style="border: 1px solid black; padding: 5px; margin: 10px 0;">  <ul style="list-style-type: none"> • If you tap a shape when selecting the eraser, the whole shape is deleted. You cannot delete a partial shape. • You cannot clear images and templates. </div>
	<p>Clears all the current drawing content. Inserted images are not cleared.</p>
	<p>Hides the toolbar after each drawing. : The toolbar is hidden while drawing. : The toolbar is always displayed.</p>
	<p>Closes the toolbar.</p>
	<p>Displays which tool you are using with your pen   or finger  (EB-1450Ui).</p> <ul style="list-style-type: none"> : Using pen tools. The color of the icon indicates the color of the pen. : Using tools to select objects and images. : Using a tool to capture the selected area. : Using a pointer tool. : Using a shape tool. : Using eraser tools. : Enlarging the projected screen. : Enlarging the selected area.













- You can display the following number and size of images on the whiteboard screen (including images stored on the clipboard).
 - Up to 20 files per page and 1920 × 1200 × 2 pixels
 - Up to 1920 × 1200 × 50 pixels for all pages
- To paste an image, you need to use the same pen that you used to cut or copy the image.
- Drawn objects are displayed at the front of the projected image. However, you can change the order by using the grouped feature.
- If objects or images are moved out of the projected screen, you may not be able to select them.









Whiteboard Mode Bottom Toolbar













The whiteboard mode bottom toolbar lets you edit the projected image and use whiteboard mode features. The whiteboard mode bottom toolbar is shown in the following illustration.







	<p>Displays the Home screen.</p>
	<p>Shares drawing contents across multiple devices and projects the shared drawing contents from other projectors.</p>
	<p>Performs one of the following:</p> <ul style="list-style-type: none"> • Save: Saves the current drawing content and returns whiteboard mode to its default status. • New meeting: Clears all the current drawing content and images, and returns whiteboard mode to its default status.

	Opens a file and reads the data into a new page.
	Captures images from a scanner and pastes them on a new page.
	<p>Selects a background template. Select Setting to add or delete user templates. You can also set user templates using a Web browser.</p> <div style="border: 1px solid gray; padding: 10px; background-color: #ffffcc;"> <ul style="list-style-type: none"> • Each time you select the ruler icon  or the grid icon , the line width or grid size changes. • If the Protect User Templates setting is set to On in the projector's Whiteboard Settings menu, you cannot change user templates in whiteboard mode.  Extended > Whiteboard Settings > Policy > Protect User Templates </div>
	Moves to the previous page. Tap and hold the icon to display the first page.

	<p>Displays a list of the page thumbnails you are editing. The blue frame indicates the current page and the green frame indicates the displayed area. You can perform the following operations using the interactive pen.</p> <ul style="list-style-type: none"> • Switch the page you want to display by selecting the thumbnail. • Scroll the display by flicking the thumbnail. • Move the displayed area by dragging the green frame. • Tap the current page to perform the following operations: <ul style="list-style-type: none"> •  : Moves the current page to the left. •  : Deletes the current page. •  : Duplicates the current page, and adds it after the current page. •  : Moves the current page to the right.
	Moves to the next page. Tap and hold the icon to display the last page.
	Adds and opens a new page.
	Prints the projected screen.
	Saves the projected screen to a file.

	Sends the projected screen by email. You need to select mail server settings before using this feature.
	Shares the current screen using EasyMP Multi PC Projection software.
	Changes the image source using the displayed list. To close the image source list, select the  icon at the top of the list.
	Enlarges or reduces the whiteboard screen. <ul style="list-style-type: none"> : Reduces the image. : Enlarges the image. : Returns to the original size. : Enlarges the selected area. : Displays the whole whiteboard screen during split screen projection. : Displays the full whiteboard screen vertically during split screen projection.
	Turns the video and audio off. Tap the screen to turn the video and audio back on.
	Splits the screen to project two images at once. Press again to return to projecting one image at a time.

	Displays the help screen for the toolbar and the bottom toolbar functions. Select Return to close the help screen.
	Closes the bottom toolbar.

 • You can select detailed settings for whiteboard mode on the projector's **Whiteboard Settings** menu.
 **Extended > Whiteboard Settings**

• You cannot use the following functions in whiteboard mode.

- E-Zoom
- Page up or down

Projecting Scanned Images in Whiteboard Mode

You can scan a paper document into a new page in whiteboard mode. Make sure a supported printer with scanning capabilities is connected to the control pad or to your network.

You need to make settings for network printers in advance.

 • Printers with ESC/P-R commands are supported.

- Certain products, such as standalone scanners, cannot use this feature. For a list of supported products, contact Epson for help.
- You cannot scan documents when the printer is in an unprintable status such as when ink has run out.

When scanning using your product, you cannot use the following scanning functions even if they are available:

- Using the scan button on your product.
- Scanning parts of the document.

- Scanning double-sided originals using an Automatic Document Feeder (ADF).

1 Load your original in the product.

2 Select the  icon on the bottom toolbar.
The Scan screen is displayed.

3 Select the following scan settings on the Scan screen. (Select **Advanced** to open the detailed menu.)

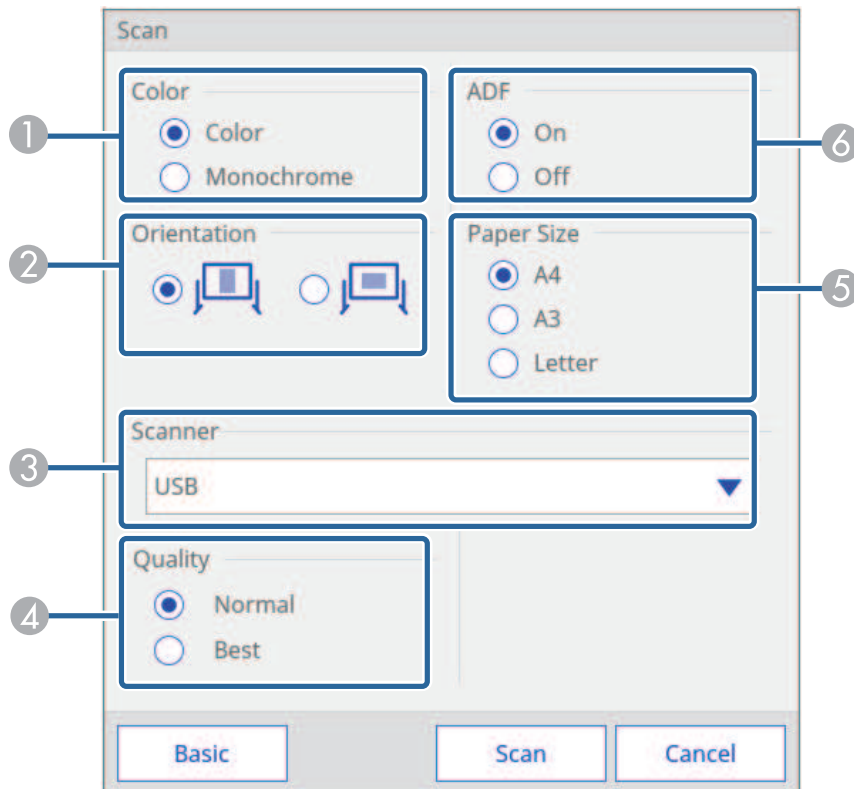

1 Select **Color** or **Monochrome**.

2 Select the orientation of the scanned document.

3 Select the scanner you want to use.

4 Set the scan quality.

5 Set the paper size.

6 Select where you loaded your original. If your product does not include an ADF, the ADF selection is ignored.

4 Select **Scan**.

The Scan screen is displayed.

After scanning, the image is projected as a new page in whiteboard mode.



When using a product with a built-in ADF, you can read up to 10 sheets. Repeat the procedure if you need to scan documents of more than 10 sheets.

Compatible File Types for Opening in Whiteboard Mode

The following file types can be opened and read into a page in whiteboard mode. Images larger than a page are reduced to fit.

Type	File Type (Extension)	Notes
Image	.jpg	The following cannot be read. <ul style="list-style-type: none"> • Images with a resolution greater than 2048 × 2048 • Files with the extension ".jpeg" • CMYK color mode formats • Progressive formats
	.png	Cannot read images with a resolution greater than 2048 × 2048.
PDF	.pdf	You can open PDF files for version 1.7 or earlier. Specify the page number to open a PDF file. If the file is password protected, enter the password.
EWF	.ewf	Specify the page number to open an EWF (Epson Whiteboard Format) file. If the file is password protected, enter the password.

Saving Drawing Contents in Whiteboard Mode

You can save the content you created on the projected screen to a file.

Caution

If you are using a multi-card reader or USB hub, operations may not be performed correctly. For best results, connect directly to the projector or the control pad.



You may not be able to use USB storage devices that incorporate security functions.

- 1** Select the  icon on the bottom toolbar.
The Save screen is displayed.

Sharing Drawings Created in Whiteboard Mode

You can share the contents of drawings you create in whiteboard mode by saving or printing them, or sending an email containing the content.

» Related Links

- "Saving Drawing Contents in Whiteboard Mode" [p.99](#)
- "Available File Format in Whiteboard Mode" [p.101](#)
- "Printing Drawing Contents in Whiteboard Mode" [p.101](#)
- "Available Printer Control Commands in Whiteboard Mode" [p.102](#)
- "Sending Emails in Whiteboard Mode" [p.102](#)
- "Creating an Address Book" [p.104](#)
- "Available Directory Service in Whiteboard Mode" [p.104](#)

2 Select the following save settings on the Save screen.

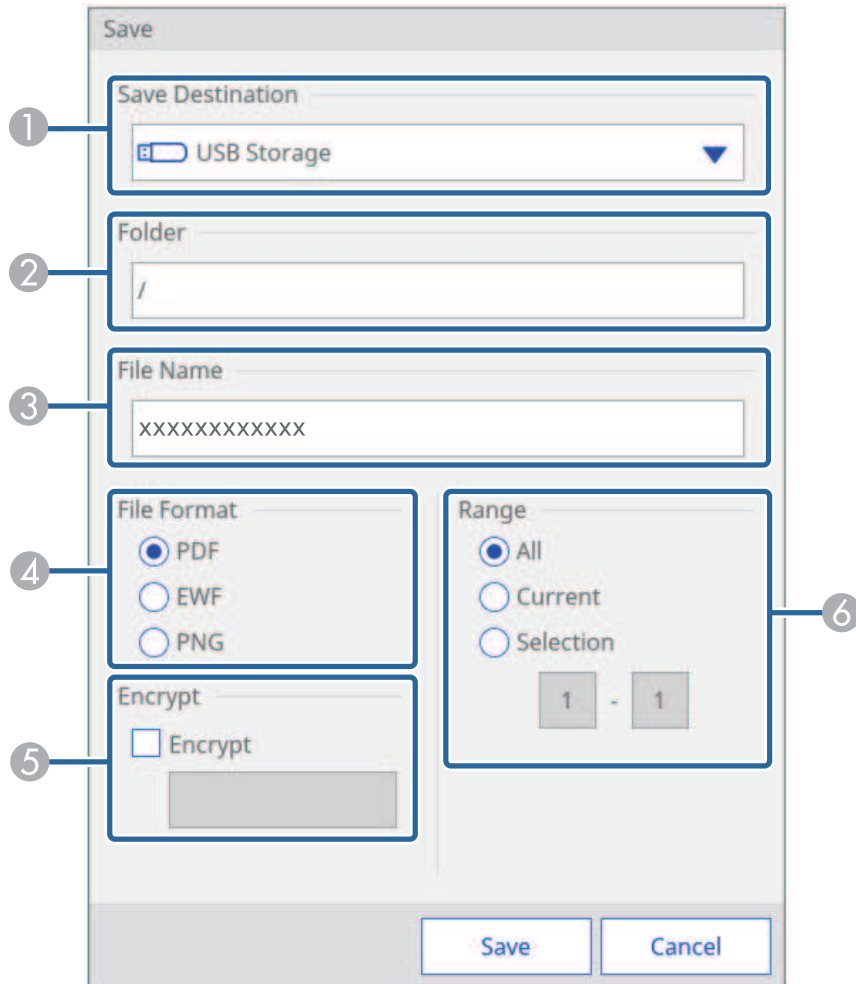

- 1 Select the destination where you want to save the file.
Select **USB Storage** or **Network Folder** to save to a connected USB storage device or network folder.
Select **PC via USB Cable** to temporarily save the file on the projector and make it available for copying from the computer. After the file is copied, it is erased.
If sharing the whiteboard, select **Browser Participants** to temporarily save the file on the projector and make it available for download through a Web browser. After the file is downloaded, it is erased.
- 2 For **USB Storage** or **Network Folder**, select the target folder using the displayed **Open** dialog box.
- 3 Enter a file name using the displayed on-screen keyboard.
- 4 Select the save format (PDF, PNG, or EWF). For **Browser Participants**, EWF is not available.
- 5 For PDFs or EWFs, select the check box and enter a password to encrypt the file.

Attention

- When you enter a password, it is displayed on the screen.
- When encrypting a file, make sure you do not forget the password.

- 6 Set the range of pages that you want to save. **Current** is selected when the save format is PNG.

3 Select **Save** (**Next** for **PC via USB Cable** or **Distribute** for **Browser Participants**).



- When **PC via USB Cable** is selected in step 2, the drawing content is temporarily saved on the projector and the instruction dialog box is displayed. Follow the on-screen instructions to save the data on your computer.
- When **Browser Participants** is selected in step 2, the drawing content is temporarily saved on the projector and following dialog boxes are displayed in Web browsers and the projector.
 - Web browsers: A dialog box is displayed to save the drawing content. You can save the file as a PDF or in PNG format.
 - Projector: A dialog box is displayed where you can check the download status. Make sure all participants finish downloading, and then close the dialog box.

Available File Format in Whiteboard Mode

You can save in the following file formats:

- PNG (Resolution: 1920 × 1200)
- PDF (set a password if necessary)
- EWF (only available for projectors that support the EWF format; set a password if necessary)

When saving the file as editable, select the EWF format. The EWF format file can only be used with the projector.



To import the EWF files saved on this projector into other projectors, you may need to update the projectors' firmware on which you want to import the EWF files.

Printing Drawing Contents in Whiteboard Mode

You can print your pages directly from the projector to a supported printer (USB or networked).

You need to make settings for network printers in advance.

☛ **Extended > Whiteboard Settings > Print**

1 Select the  icon on the bottom toolbar. The Print screen is displayed.

2 Select the following print settings on the Print screen. (Select **Advanced** to open the detailed menu.)

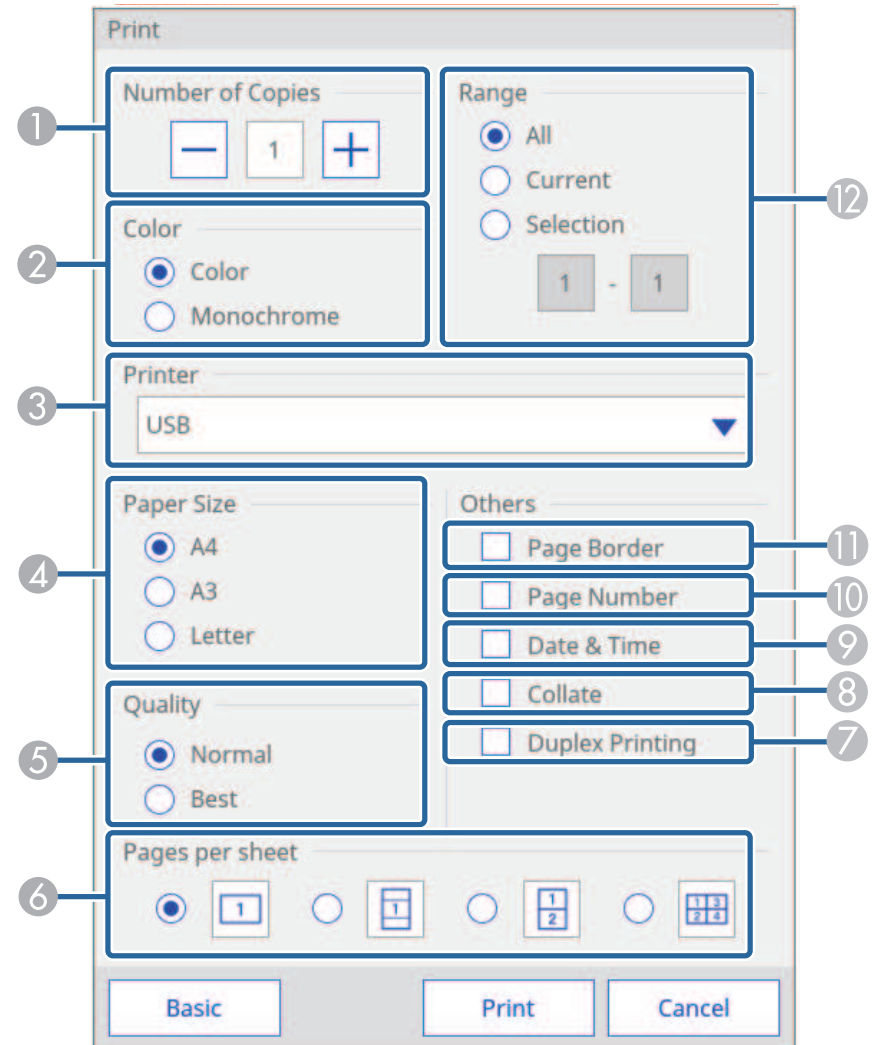

- ① Specifies the number of copies. You can specify up to 20 sheets.
- ② Specifies the print color.
- ③ Displays a list of connected printer names. Select the printer you want to use.
- ④ Set the print paper size.
- ⑤ Set the print quality.
- ⑥ Set the number of pages per sheet.
- ⑦ If your printer supports double-sided printing, select whether to print on both sides.
- ⑧ Set whether to collate pages when printing.
- ⑨ Set whether to print a date and time on each page.
- ⑩ Set whether to print a page number on each page.
- ⑪ Set whether to add a border to each page.
- ⑫ Set the range of pages that you want to print.

3 Select Print.

Available Printer Control Commands in Whiteboard Mode

The following printer* control commands are supported.

Control commands	Connection method
ESC/P-R	USB or over a network
ESC/Page, ESC/Page-Color	Over a network
PCL6	

* Not all printers are supported. For more details on supported models, contact Epson for help.

Sending Emails in Whiteboard Mode

You can attach an image of the screen projected in whiteboard mode and send it by email.

You can specify up to 50 addresses.



- To send emails, you need to make mail server settings in advance.
 ● **Extended > Whiteboard Settings > Mail**
- The address set for the sender in the projector's **Whiteboard Settings** menu is used as the sender's address. If the sender's address has not been set, the address set for the recipient as displayed as the sender.
- You cannot edit the text in the email.

- 1** Select the  icon on the bottom toolbar.
The Mail screen is displayed.

2 Select the following email settings on the Mail screen.

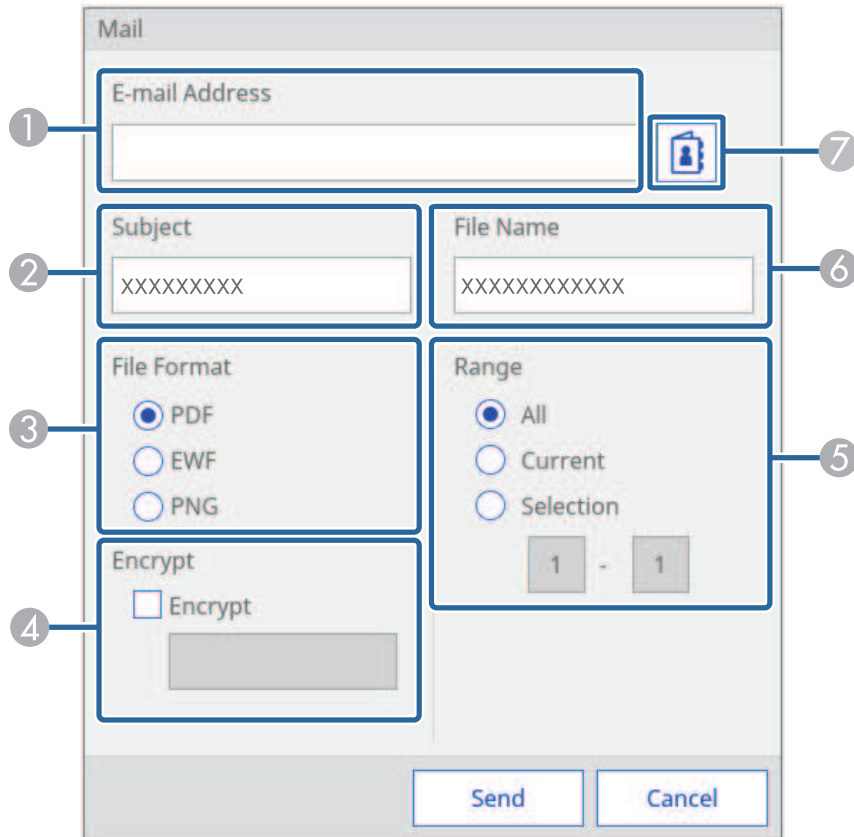

1 Enter the email address for the recipient using the displayed on-screen keyboard. The email address you set is stored until you create a new meeting or turn off the projector.



When you set **Disallow Address Input** to **On** in the projector's **Whiteboard Settings** menu, you cannot enter the email address directly. Set **Disallow Address Input** to **Off** first.

☛ **Extended > Whiteboard Settings > Mail > Disallow Address Input**

- 2** Enter the subject for the email.
- 3** Select the format for the attached file (PDF, PNG, or EWF).
- 4** For PDFs or EWFs, select the check box and enter a password to encrypt the file.

Attention

- When you enter a password, it is displayed on the screen.
- When encrypting a file, make sure you do not forget the password.

- 5** Set the range of pages that you want to send.
- 6** Enter the file name for the attachment.
- 7** Specify the email address for the recipient using the displayed E-mail Address dialog box. You can specify up to 50 addresses.

You can set the address book using the Web Control screen or the directory service in the projector's **Whiteboard Settings** menu.

☛ **Extended > Whiteboard Settings > Directory Settings**

3 Select **Send**.



- If there is a lot of content on the projected screen, it may take a while to send the email.
- You may not be able to send the email depending on the destination mail server settings. Contact your network administrator about the mail server settings in advance.

Creating an Address Book

When sending e-mails from whiteboard mode, you can choose e-mail addresses from an address book. You can create the address book by loading a text file of up to 999 addresses through the Web Control screen.



Addresses are displayed in the order they appear in the text file.

- 1** Create the text file containing the list of addresses you want to add to the address book. The file must have the following characteristics:
 - Tab-delimited
 - Each line must contain a pair of strings separated by a tab: <name> <tab> <email_address>
 - Each line can contain up to 256 characters.
 - Filename with a .txt extension
 - Character code must be Unicode

An example of a text file:

Joe Smith	xxxxxx@xxxx.com
Mary Jones-Smith	xxxxxx@xxxx.com
John Q. Public	xxxx@xxxxxx.com

- 2** Make sure the projector is turned on.
- 3** Start your Web browser on a computer connected to the network.
- 4** Type the projector's IP address into the browser's address box and press the computer's **Enter** key.
- 5** Select the  icon to access the Web Control screen.



- You may need to log in before you see the Web Control screen. If a login screen is displayed, enter your user name and password. (The user name is **EPSONWEB** and the default password is **admin**.)
- You can change the password in **Web Control Password** from the projector's **Network** menu.
 - ☛ **Network > Network Configuration > Basic > Web Control Password**
- You need to select the **Config** icon to access the Web Control screen using your mobile device.

- 6** Select **Whiteboard Settings > Mail > Address Book Settings > Address Book File** and select the **Choose File** button.
- 7** Select the address book file and select **Set**.
The address book file is uploaded to the projector.
- 8** To delete the address book, select **Whiteboard Settings > Mail > Address Book Settings > Delete Address Book** and select **Set**.

Available Directory Service in Whiteboard Mode

The following directory service servers are supported.

Server type	Directory service server
Operating system	Windows Server 2008 R2 Service Pack 1 Windows Server 2012
Port	Variable (default is 389)
Authentication	Anonymous (no authentication) Digest-MD5
Encryption	SASL layer encryption (SSL/TLS is not supported)

Notes for search

- Up to 100 matched addresses are listed.
- You can specify up to 200 search conditions.
- Filtering is not available.
- You can search addresses using alphanumeric characters.

Whiteboard Sharing with Other Devices

You can share the whiteboard screen with other devices that are connected to the same network. This allows you to view and draw on the whiteboard screen at the same time from other projectors or tablet devices.

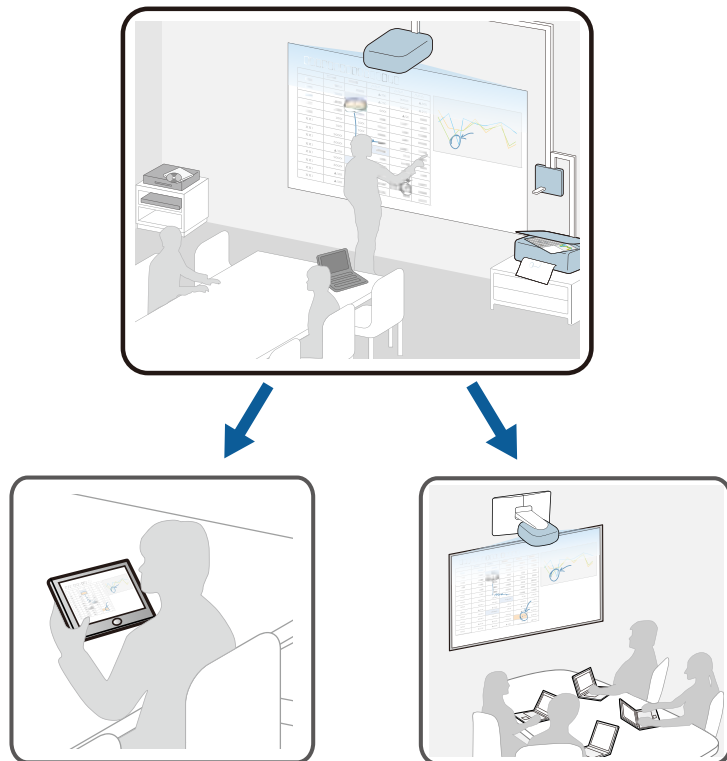

You can share the whiteboard screen with projectors that support the whiteboard sharing feature. You may need to update the projectors' firmware.

When sharing a whiteboard, you need to connect the projector to the network.

To connect to the network using a cable, connect a LAN cable to the projector.

To connect to the network wirelessly, install the supplied wireless LAN unit on the projector, and then configure the **Wireless LAN** settings from the **Network** menu.

☛ **Network > Network Configuration > Wireless LAN**

Make sure that the **Secure HTTP** setting is set to **On** in the projector's **Network** menu to share the whiteboard.

▶▶ Related Links

- "Sharing Whiteboard Screen with Other Devices" [p.105](#)
- "Connection to the Shared Whiteboard" [p.108](#)
- "Connecting to a Shared Whiteboard from a Projector" [p.108](#)
- "Available Features when Connecting to a Whiteboard Screen" [p.109](#)
- "Connecting to a Shared Whiteboard from a Computer or Other Device via a Web Browser" [p.111](#)
- "Supported Web Browsers for Sharing a Whiteboard" [p.112](#)
- "Toolbar for Whiteboard Screen Connecting via a Web Browser" [p.112](#)

Sharing Whiteboard Screen with Other Devices

You can share your whiteboard with up to 15 other devices on the same network, including other projectors that support whiteboard sharing, computers, mobile devices, and other devices. The content is shared to other devices where it can be viewed and saved. You can also draw on the projector's whiteboard screen from the other devices.

When sharing your whiteboard screen, you need to open the following network ports.

Port	Protocol	Usage	Communication
80	HTTP	Connect/Transfer images	two-way
443	HTTPS		two-way

 The communication bandwidth for sharing the whiteboard screen differs depending on the amount of drawing content. Also, depending on the total amount of drawing content, a broad bandwidth is temporarily required when the connections starts.

1 Select the  icon on the bottom toolbar.

 You can also select **Whiteboard Sharing** on the Home screen.

The Whiteboard Sharing screen is displayed.

2 Select **Start sharing with this whiteboard**.

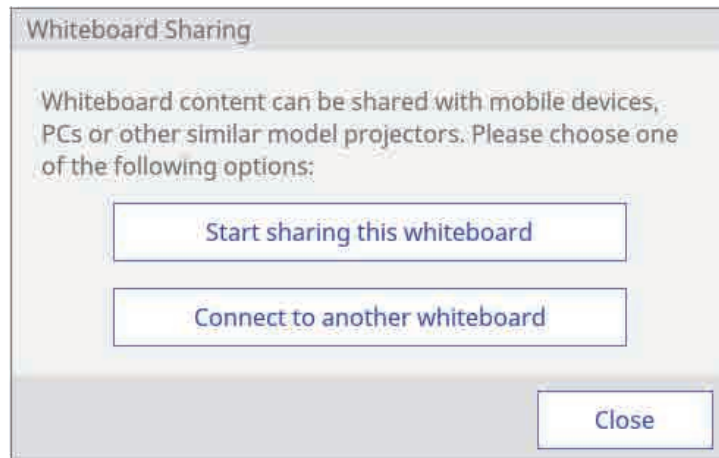

A PIN code is displayed for connecting to the projector.

3 Check the PIN code. If necessary, change it. You can set up to seven digits for the PIN code.

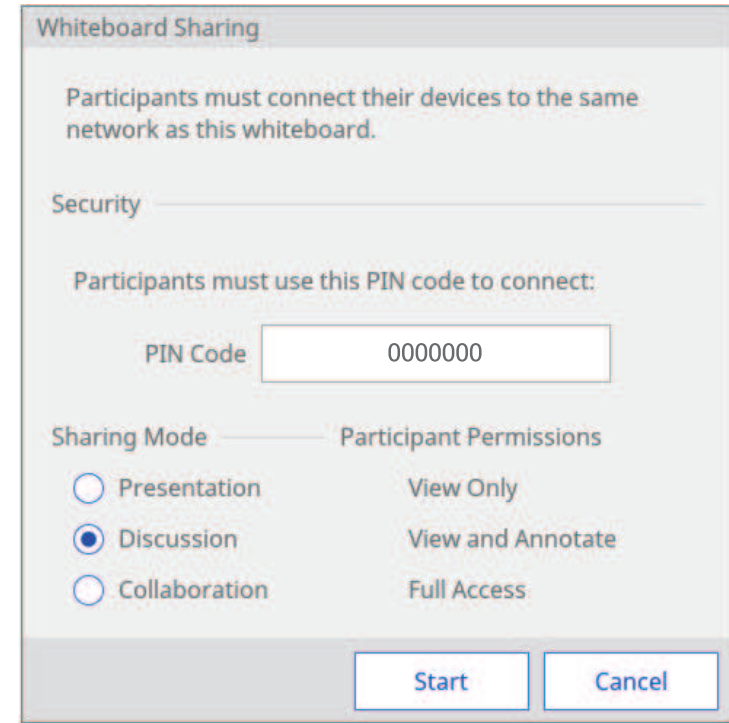

 Once you set the PIN code, you cannot change it until you end whiteboard sharing.

4 Select one of the following as the **Sharing Mode** setting to permit access to features by devices connecting to the whiteboard:

- **Presentation:** Connected devices can view and save the whiteboard screen.
- **Discussion:** Connected devices can draw on the shared screen.
- **Collaboration:** Connected devices can access all available features except creating a new meeting.

5 Select **Start**.

Whiteboard screen sharing with other devices is now available.

The bar indicating the shared status is displayed at the top middle of the screen. You can move the status bar right and left by tapping and dragging the right or left end of the bar.

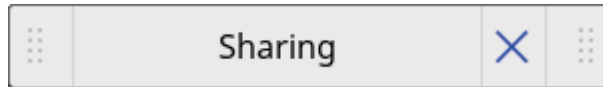

6 Check the connection information for the shared whiteboard and connect to the projector from other devices.

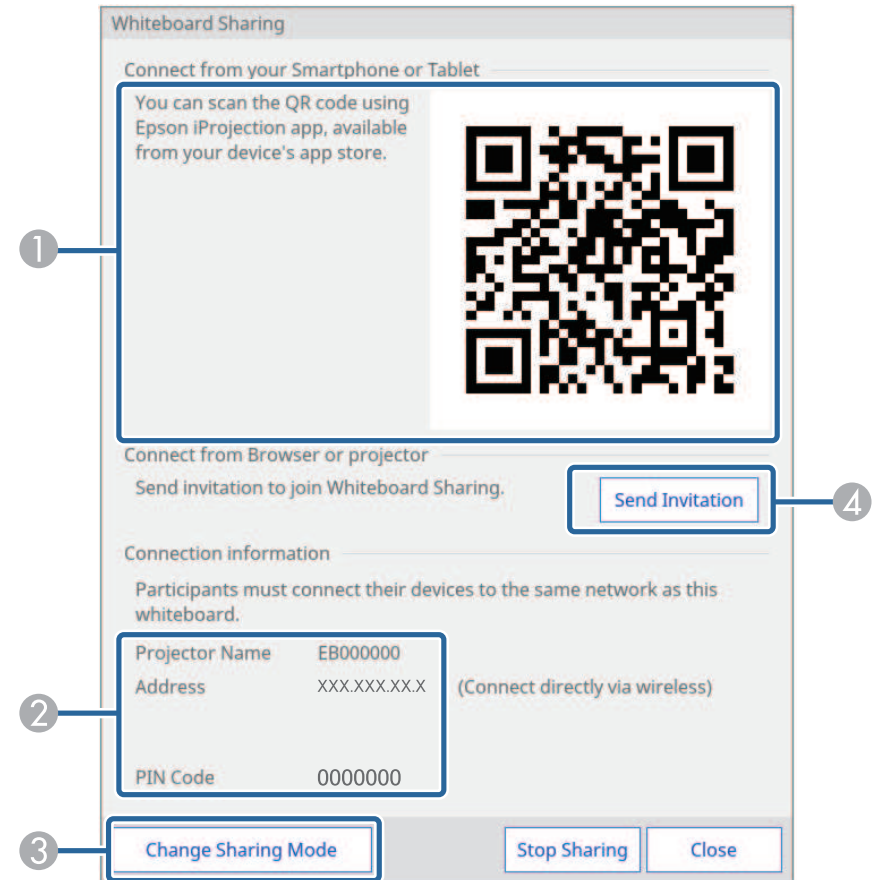

1 Displays a QR code to connect to the shared whiteboard from your mobile device using the Epson iProjection app.

② Displays the information to connect to the shared whiteboard from other projectors.

- **Projector Name/Address:** Displays the projector's address for connecting.
- **PIN Code:** Displays the PIN code you set in step 3.

Caution

- If the PIN code is not entered correctly in the external devices, you cannot connect to the projector.
- To avoid the risk of data being disclosed, restrict the PIN code to the users connecting to the projector.

③ Sets editing permissions for connected users if necessary.

④ Sends email invitations using the displayed dialog box.

7 Select **Close**.

The projector's whiteboard screen is displayed on the connected device.



• To finish sharing the whiteboard screen, select the  icon on the bottom toolbar, and then select **Stop Sharing** on the displayed screen. You can also close the shared whiteboard by selecting the

 icon on the status bar.

- When a message is displayed, select **OK** to finish and discard the content on the shared whiteboard screen.
- To save the shared whiteboard screen on other devices before you finish sharing the whiteboard, select **Distribute to Participants** and **Distribute**. Make sure the screen is saved, and then select **Done**.
- If there is a lot of drawing content and images pasted on the whiteboard screen, it may take a while to be reflected on other projectors and Web browsers.

Connection to the Shared Whiteboard

You can connect to a projector that is sharing its whiteboard on the same network. You can view, save, and draw on the shared whiteboard from your connected projector, computer, or device.

Caution

All drawing content on the projected screen is erased if you connect to another whiteboard screen.



- When connecting to a shared whiteboard, you need to know the connection information. Select the  icon on the bottom toolbar or tap the status bar on the projector that is sharing its whiteboard and check the information on the displayed Shared Whiteboard screen.
- Available features depend on the **Sharing Mode** setting of the projector you are connecting to. If the **Sharing Mode** setting is changed while connecting to the shared whiteboard, the available features for the connected devices are also changed.
- You can connect up to 15 devices to one projector.

Connecting to a Shared Whiteboard from a Projector

You can connect another projector on the same network to a projector that is sharing its whiteboard.



We recommend using an SSL connection to make the connection from other projectors. Set the **Secure HTTP** setting to **On** in the projector's **Network** menu.

 **Network > Network Configuration > Others > Secure HTTP**

1 Press the [Whiteboard] button on the control pad or the remote control.

The projector displays the whiteboard.

2 Select the  icon on the bottom toolbar.
The Shared Whiteboard screen is displayed.

3 Select **Connect to the shared whiteboard**.

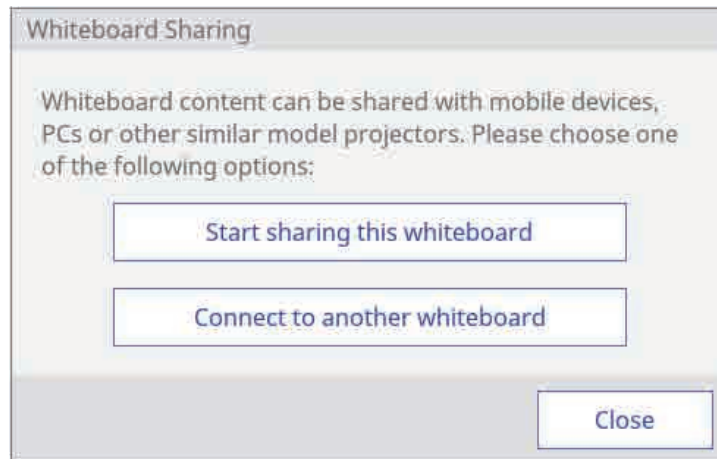

4 Check the displayed message, and then select **OK**.

5 Enter the address and PIN code.

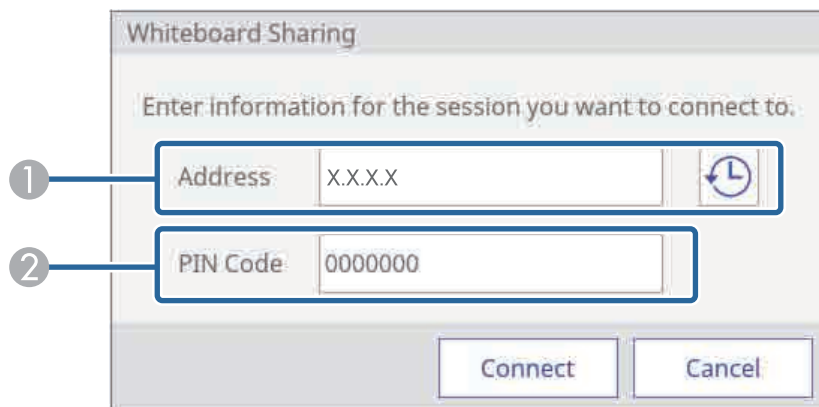

1 Enter the address for the projector you want to connect to.

Select the  icon to display the addresses for the last 10 projector connections.

Connection logs are saved even if the projector is turned off.

2 Enter the PIN code for the projector you want to connect to.



If you enter the wrong PIN code 10 times in 10 minutes, you cannot connect to the whiteboard for three minutes.



6 Select **Connect**.

Both projectors display the shared whiteboard screen.

The bar indicating the shared status is displayed at the top middle of the screen. You can move the status bar right and left by tapping and dragging the right or left end of the bar.

7 Select **Close**.













- To disconnect from the shared whiteboard, select the  icon on the bottom toolbar, and then select **Stop Sharing** on the displayed screen. You can also disconnect from the shared whiteboard by selecting the  icon on the status bar. When a message is displayed, select **OK**.
- If there is a lot of drawing content and images pasted on the whiteboard screen, it may take a while to be reflected on other projectors and Web browsers.











Available Features when Connecting to a Whiteboard Screen

Available features depend on the **Sharing Mode** setting of the projector you are connecting to.

Available features for all authorities

-  : Whiteboard Sharing (for disconnection)
-  : Print
-  : Save
-  : Send E-mails
-  : Screen Sharing
-  : Source Select
-  : Zoom
-  : A/V Mute
-  : Split Screen
-  : Help

Available features for Discussion and Collaboration

-  : Pointer
-  : Undo
-  : Redo
-  : Rectangle Select
-  : Free Select
-  : Shapes
-  : Read Image
-  : Pen
-  : Highlighter Pen
-  : Black Pen
-  : Red Pen
-  : Blue Pen



Available features for Collaboration

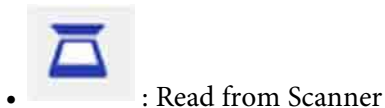
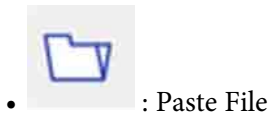

You cannot use the features not described here.

Connecting to a Shared Whiteboard from a Computer or Other Device via a Web Browser

You can connect to a shared whiteboard from a computer or device on the same network using a Web browser.

- 1** Connect your device to the same network as the projector you want to connect to.



The connection method differs depending on the device. See the documentation supplied with the device. Check the Wi-Fi settings when using a tablet device.

- 2** Start a Web browser on the device.

- 3** Enter the whiteboard IP address into a web browser in this format: for example, "192.168.1.100".



If available, you can also click the link in the invitation email sent from the projector that is sharing its whiteboard.

- 4** Select the icon.

You see a prompt to enter a PIN code.

- 5** Enter the PIN code for the projector you want to connect to, and then select **Connect**.

You see the shared whiteboard content and toolbar on your computer or device.



- To disconnect from the shared whiteboard, select the  icon on the bottom toolbar and then select **Disconnect**. You can also disconnect from the shared whiteboard by closing the Web browser.
- If there is a lot of drawing content and images pasted on the whiteboard screen, it may take a while to be reflected on other projectors and Web browsers.
- Shared whiteboard content is encrypted. Some Web browsers use SSL encryption. You can continue to connect to the Web browser even if a certificate error is displayed.

Supported Web Browsers for Sharing a Whiteboard

You can connect to a shared whiteboard using the web browsers described here.

Operating system	Web browser
Windows 7 or later	Internet Explorer 10/11
OS X 10.7 or later	Safari 6/7/8
iOS 7.0 or later	Standard browser
Android OS 4.0 or later	Standard browser
Chrome OS (Chromebook)	Chrome Browser





The available drawing range narrows depending on the screen size of the device.

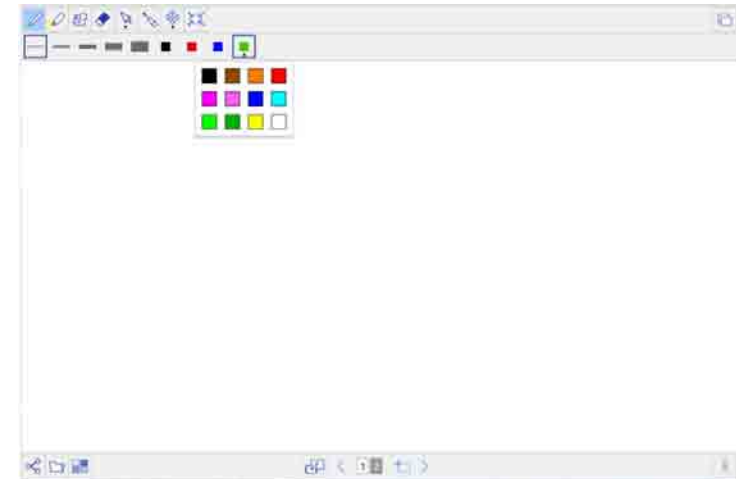

Toolbar for Whiteboard Screen Connecting via a Web Browser

When connected through a web browser, the whiteboard toolbars allow you to interact with the shared whiteboard. Available features depend on the **Sharing Mode** setting of the projector you are connecting to.













Available features for all authorities

	<p>Opens another window and displays the projected image of the projector you are connecting to.</p> <div data-bbox="1496 1142 2101 1289" style="border: 1px solid black; padding: 5px;">  <p>Shared projected image content is encrypted using SSL. You can continue to connect to the Web browser even if a certificate error is displayed.</p> </div>
	<p>Disconnects.</p>

	Adjusts the view of the display in the web browser window. The following operations are available: <ul style="list-style-type: none"> • Fit page • Fit width • Fit height • Enlarge • Reduce
	Displays the entire whiteboard.
	Saves the whiteboard screen as a PDF or PNG file depending on the settings of the projector you are connecting to; available only when Browser Participants or Distribute to the participants. is selected on the projector.









Available features for Discussion and Collaboration

	Selects a pen for drawing.
	Selects a translucent highlighter pen for drawing.
	Selects a shape to place on the screen.
	Selects the eraser tool so you can tap on content and select OK to delete it; you cannot delete partially drawn content.

	<p>Selects an object or image. When dragging, a frame that indicates the selection range is displayed. You can select objects and images within the frame.</p> <p>You can perform the following operations while an object or an image is selected:</p> <ul style="list-style-type: none"> • When dragging, you can move the objects and images within the frame. • When selecting the  icon again, you can perform the following operations: <ul style="list-style-type: none"> • Cut • Copy • Paste • Group • Ungrouped • Delete • When dragging an edge of the frame, you can enlarge or reduce the objects and images within the frame. • When dragging  at the top of the frame, you can rotate the objects and images within the frame.
	Displays the draggable pointer on the whiteboard screen and all connected devices.
	Selects the line thickness for the current pen or shape.
	Selects the color of the selected pen or shape. Select the  icon to select other colors.

	<p>Loads an image on the whiteboard. You can select files that meet the following specifications:</p> <ul style="list-style-type: none"> • Format: PNG, JPEG • Resolution: 2048 × 2048 maximum • Pixel Count: 2 million or less <p>Images larger than a page are reduced to fit.</p>
---	--

Available features for Collaboration

	<p>Selects a background template.</p>
	<p>Controls which whiteboard page is displayed on the shared whiteboard</p> <ul style="list-style-type: none"> •  : Synchronizes the page with the connected whiteboard. When you edit the page, the change is reflected on the shared whiteboard. •  : Displays a page that differs from the connected whiteboard. You can only modify pages that are displayed on the shared whiteboard.
	<p>Displays the page number of the edited pages.</p> <ul style="list-style-type: none"> • Select the  icon to move to the previous page. • Select the  icon to move to the next page.
	<p>Adds and opens a new page.</p>

 You cannot use features that are not described here.





Annotation mode lets you project from a computer, tablet, video device, or other source and add notes to your projected content using the interactive pens or your finger (EB-1450Ui). You can use both pens at the same time. You can also use both pens and your finger at the same time.

» Related Links

- "Starting Annotation Mode" [p.115](#)
- "Annotation Mode Toolbar" [p.116](#)
- "Annotation Mode Bottom Toolbar" [p.117](#)
- "Using Drawing Contents of Annotation Mode" [p.118](#)

Starting Annotation Mode

To draw on the projected screen using annotation mode, you need to display the annotation mode toolbar and bottom toolbar.

- 1** Project an image from a connected device.
- 2** Hold an interactive pen close to the projected screen or tap the projected screen using your finger (EB-1450Ui).
- 3** To write or draw, tap the  or  toolbar tab.

You see the toolbar on the projected image, for example:





- 1** Annotation mode drawing toolbar
- 2** Annotation mode bottom toolbar













When the toolbars are displayed, you can write on the projected screen using the interactive pen or your finger.







The drawing toolbar provides drawing tools such as a pen and other tools.

The bottom toolbar provides additional tools, such as tools for controlling the projector or saving the projected screen.



- You can move the toolbar by tapping and dragging the bar at the top or bottom of the toolbar.
- You can move the bottom toolbar right and left by tapping and dragging the right or left end of the bar.
- To switch the annotation mode to whiteboard mode, press the [Whiteboard] button on the control pad or the remote control, or tap and drag the  or  annotation mode tab.



	Redoes the last undo.
	Writes or draws free-form lines with custom pen. Select the  icon to change custom pen color and width.
	Writes or draws free-form lines with a transparent highlighter pen. Select the  icon to change highlighter pen color and width.
	Black pen (fine point on left, thick on right).
	Red pen (fine point on left, thick on right).
	Blue pen (fine point on left, thick on right).
	Eraser (thin width on left, thick on right).
	Clears all drawings.
	Hides or shows the toolbar while drawing.  : The toolbar is hidden while drawing.  : The toolbar is always displayed.







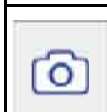



	Closes the toolbar.
	Displays which tool you are using with your pen  or finger  .  : Using pen tools. The color of the icon indicates the color of the pen.  : Using eraser tools.  : Using your pen or finger as a mouse.

Annotation Mode Bottom Toolbar

The annotation mode bottom toolbar allows you to save, print your pages, or control the various projector features. The annotation mode bottom toolbar is shown in the following illustration.



	Displays the Home screen.
	Takes a snapshot of the projected screen. After taking the snapshot, the image is pasted onto a new page in whiteboard mode.
	Prints the projected screen.

	Saves the projected screen in JPG format.
	Shares the current screen using EasyMP Multi PC Projection software.
	Changes the image source using the displayed list. To close the image source list, select the  icon at the top of the list.
	Enlarges or reduces the projected image.
	Turns the video and audio off. Tap the screen to turn the video and audio back on.
	Pauses video action.
	Increases or decreases the volume.
	Splits the screen to project two images at once. While performing the split screen projection, select this icon to make detailed settings to use the interactive features in the split screen projection.
	Shows or hides the bottom toolbar. The tab can be moved right and left.

 You cannot capture images or print and save content that is protected by HDCP.

Using Drawing Contents of Annotation Mode

You can share drawing content created in annotation mode by saving and printing the data.

» Related Links

- "Saving Drawing Contents in Annotation Mode" [p.118](#)
- "Printing Drawing Contents in Annotation Mode" [p.118](#)

Saving Drawing Contents in Annotation Mode

You can save drawing content you created on the projected screen to a USB storage device or a network folder. You can save in JPEG format. The file is saved in the location set in the **Save** menu under the projector's **Whiteboard Settings** menu. An error occurs if you cannot access the set location. The file name is set automatically.

 **Extended** > **Whiteboard Settings** > **Save**

Select the  icon on the bottom toolbar.

The file is saved automatically.

Printing Drawing Contents in Annotation Mode

You can print the drawing content you created using the printer settings in the **Print** menu under the projector's **Whiteboard Settings** menu. An error occurs if a printer is not connected.

 **Extended** > **Whiteboard Settings** > **Print**

- 1** Select the  icon on the bottom toolbar.
The Print screen is displayed.

- 2** Specify the number of copies on the Print screen (up to 20 sheets).
- 3** Select **Print**.

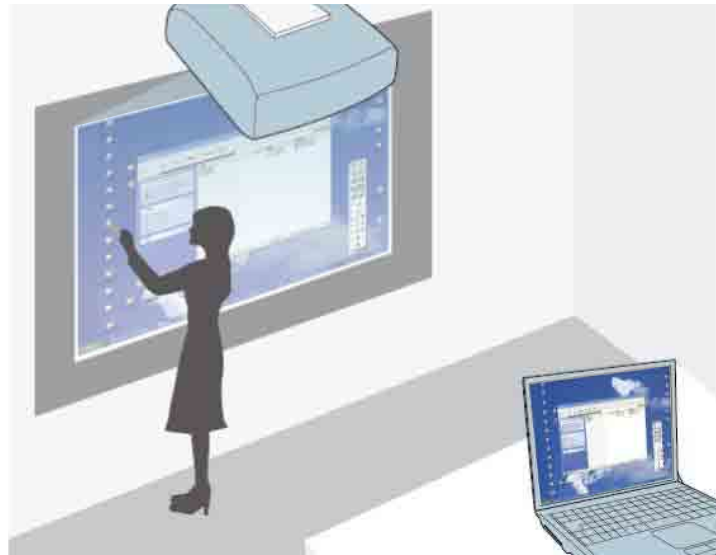

When the projector is connected to a computer with a USB cable, you can operate the computer from the projected screen using the interactive pens or your finger (EB-1450Ui), just as you would with a mouse. You can navigate, select, and interact with your computer programs from the projected screen.



- When you use multiple displays with Windows 7 or later and use computer interactive mode on the secondary display, make the following settings:
 - Set the **Pen Operation Mode** setting to **Windows/Mac Mode** in the **Easy Interactive Function** setting in the projector's **Extended** menu.
 - Go to **Control Panel > Hardware and Sound > Table PC Settings > Setup** to launch the setup program and configure the interactive features.

If you set up a third display, you cannot use interactive features with that display.

You cannot write or draw across multiple screens.

- To use computer interactive mode over a network, you need to install EasyMP Multi PC Projection version 2.10 or later (for Windows and OS X).

» Related Links

- "Computer Interactive Mode System Requirements" [p.120](#)
- "Using Computer Interactive Mode" [p.121](#)
- "Adjusting the Pen Operation Area" [p.123](#)
- "Installing Easy Interactive Driver on OS X" [p.124](#)

Computer Interactive Mode System Requirements

Your computer must use one of the following operating systems to use the computer interactive mode.

Windows	Windows Vista Service Pack 2
	<ul style="list-style-type: none"> • Ultimate (32-bit) • Enterprise (32-bit) • Business (32-bit) • Home Premium (32-bit) • Home Basic (32-bit)
	Windows 7 Service Pack 1
	<ul style="list-style-type: none"> • Ultimate (32- and 64-bit) • Enterprise (32- and 64-bit) • Professional (32- and 64-bit) • Home Premium (32- and 64-bit)
	Windows 8
<ul style="list-style-type: none"> • Windows 8 (32- and 64-bit) • Windows 8 Pro (32- and 64-bit) • Windows 8 Enterprise (32- and 64-bit) 	
Windows 8.1	
<ul style="list-style-type: none"> • Windows 8.1 (32- and 64-bit) • Windows 8.1 Pro (32- and 64-bit) • Windows 8.1 Enterprise (32- and 64-bit) 	
Windows 10	
<ul style="list-style-type: none"> • Windows 10 Home (32- and 64-bit) • Windows 10 Pro (32- and 64-bit) 	

Mac	<p>OS X</p> <ul style="list-style-type: none"> • OS X 10.7.x • OS X 10.8.x • OS X 10.9.x • OS X 10.10.x • OS X 10.11.x
Ubuntu	<p>Ubuntu</p> <ul style="list-style-type: none"> • 14.10 • 15.04 • 15.10 • 16.04 LTS

Using Computer Interactive Mode

You can control your computer programs from the projected screen using computer interactive mode.

1 If you are using OS X, install the Easy Interactive Driver on your computer the first time you use the interactive features.

2 Connect the projector to your computer using a USB cable.



- When using the control pad, you need to connect the projector, the control pad, and your computer using USB cables.
- When using computer interactive mode over a network, you do not need a USB cable.

3 Turn on the projector.

4 Project your computer screen.

5 Press the [Menu] button, select the **Extended** menu, and then press [Enter].

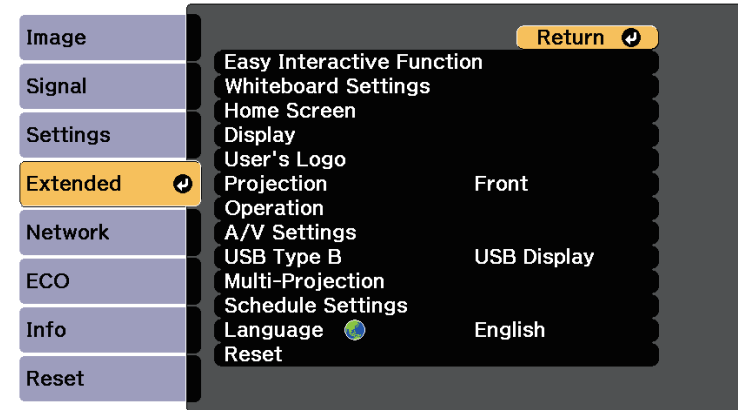

6 Select the **USB Type B** setting, and then press the [Enter] button.

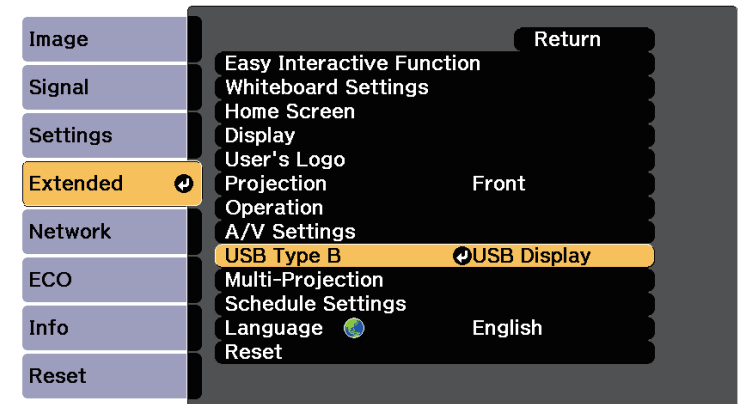

7 Select one of the following:

- To use computer interactive mode with a computer cable, an HDMI cable, or over a network, select **Easy Interactive Function**.

- To use computer interactive mode and USB Display at the same time, select **USB Display/Easy Interactive Function**.



 When projecting using USB Display, response time may be slower.

Using two interactive pens at the same time may cause interference in some applications. Move the unused interactive pen away from the projection screen.

Select the **Pen Operation Mode** setting in the **Easy Interactive Function** setting in the projector's **Extended** menu according to the operating system of the connected computer.



☛ **Extended > Easy Interactive Function > Pen Operation Mode**

Image	[Easy Interactive Function]	Return
Signal	[General]	
Settings	Auto Calibration	
	Manual Calibration	
	Touch Unit Setup	
Extended	Pen Mode	PC Free Annot...
	Hovering	Off
Network	Advanced	
ECO	[PC Interactive]	
	Pen Operation Mode	Windows/Mac...
Info	Enable Right Click	Off
	Advanced	
Reset		

 The  icon is displayed on the right the first time. Next time, it is displayed on the side from which you last opened the toolbar.

If the  icon is not displayed, set the **Pen Mode Icon** setting to **On** in the projector's **Extended** menu.

☛ **Extended > Display > Pen Mode Icon**

11 Select the  icon, and then select the  icon.



 You can also change to computer interactive mode by doing the following:

- Pressing the [Pen Mode] button on the remote control.
- Changing the **Pen Mode** setting on the projector's **Extended** menu to **PC Interactive**.

☛ **Extended > Easy Interactive Function > Pen Mode**

- 8** Press the [Menu] button to exit the menus.
- 9** Make sure you have calibrated the first time you use your projector.
- 10** Hold an interactive pen close to the projected screen, or touch the projected screen with your finger.

The  icon is displayed on the projected screen.

You can now operate the computer using the interactive pen or your finger. You can also operate the following:

- The Tablet PC input panel in Windows 7 or Windows Vista.
- Ink Tools for annotation in Microsoft Office applications.

- » **Related Links**
- "Windows Pen Input and Ink Tools" [p.132](#)
 - "Pen Calibration" [p.82](#)
 - "Easy Interactive Driver System Requirements" [p.288](#)
 - "Installing Easy Interactive Driver on OS X" [p.124](#)

- "Using the Interactive Features over a Network" p.131
- "Calibrating for Touch Operations with Your Finger" p.87

Adjusting the Pen Operation Area

The pen operation area is normally adjusted automatically if you connect a different computer or adjust the computer's resolution. If you notice that the pen position is incorrect when you operate your computer from the projected screen (computer interactive mode), you can adjust the pen area manually.

 Manual adjustment is not available when projecting from a LAN source.

- 1 Switch to computer interactive mode, if necessary.
- 2 Press the [Menu] button, select the **Extended** menu, and then press [Enter].

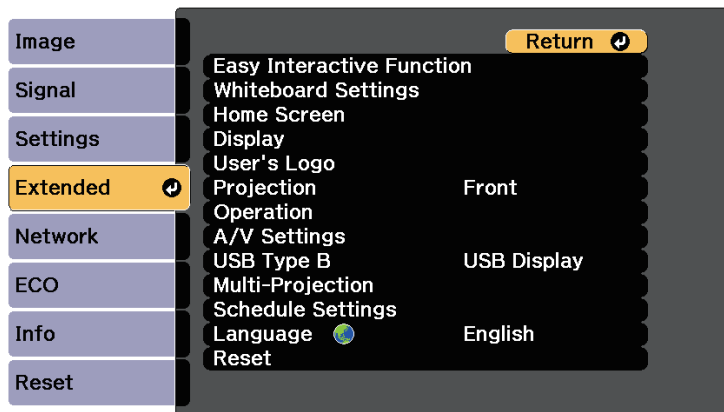

- 3 Select the **Easy Interactive Function** setting and press [Enter].

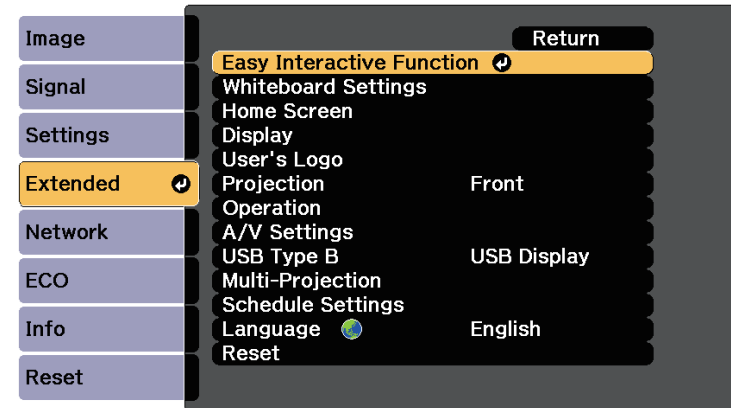

- 4 In the **PC Interactive** section, select **Advanced**, and then press [Enter].

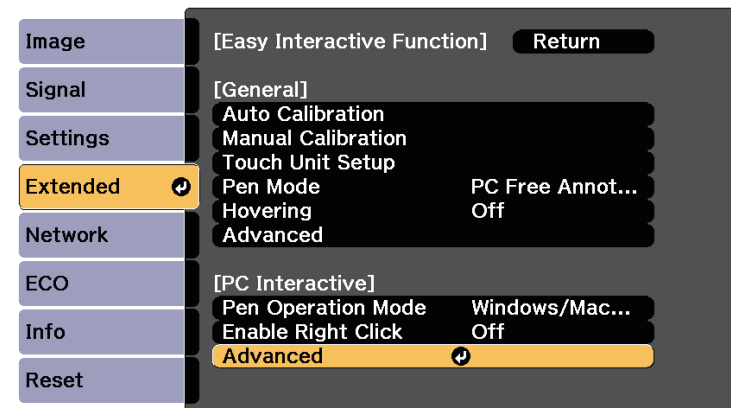

- 5** Select **Manual Adj. Pen Area** and press the [Enter] button.

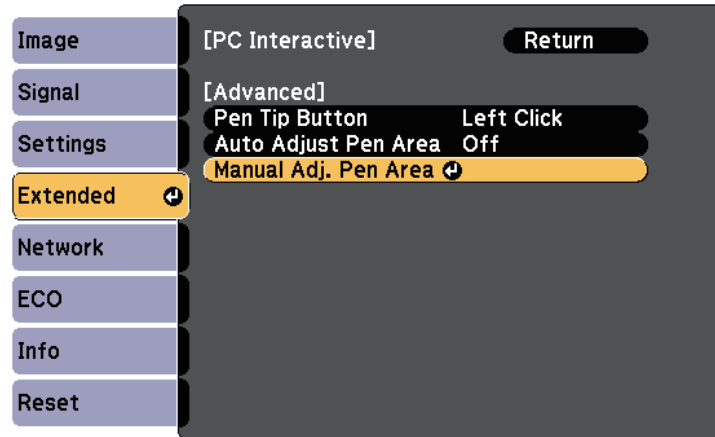

When **Auto Adjust Pen Area** is set to **On**, change to **Off**.

- 6** Select **Yes** and press the [Enter] button.

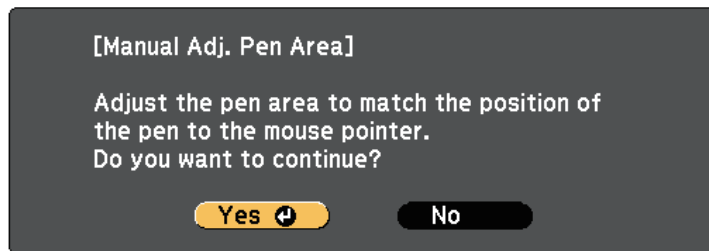

The mouse pointer moves toward the top left corner.

- 7** When the mouse pointer stops at the top left corner of the image, touch the tip of the pointer with the pen.

The mouse pointer moves toward the bottom right corner.

- 8** When the mouse pointer stops at the bottom right corner of the image, touch the tip of the pointer with the pen.

» Related Links

- "Using Computer Interactive Mode" [p.121](#)

Installing Easy Interactive Driver on OS X

Install Easy Interactive Driver on your computer to use computer interactive mode.



You may have already installed Easy Interactive Tools using the **Easy Install** option, which also installs Easy Interactive Driver. See the *Easy Interactive Tools Operation Guide* in the Document CD-ROM for details.

- 1** Turn on your computer.
- 2** Insert the EPSON Projector Software for Easy Interactive Function CD into the computer.
You see the EPSON window.
- 3** Double-click the **Install Navi** icon in the EPSON window.
- 4** Select **Custom Install**.
- 5** Follow the on-screen instructions to install the software.
- 6** Restart your computer.



You can easily switch the interactive mode.

- To switch between computer interactive mode and annotation mode, select one of the following icons:
 - To change from annotation mode to computer interactive mode:





- To change from computer interactive mode to annotation mode:

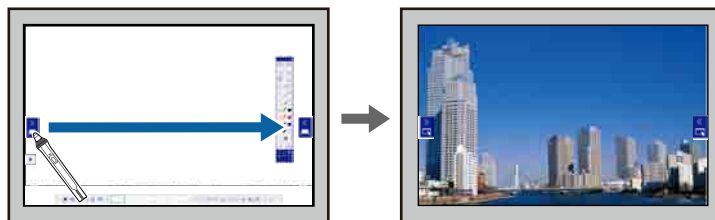

- To switch between annotation mode and whiteboard mode, select one of the following tabs:
 - To change from whiteboard mode to annotation mode, tap and drag the  or  annotation mode tab to the edge of the screen.



- To change from annotation mode to whiteboard mode, tap and drag the  or  whiteboard mode tab to the edge of the screen.

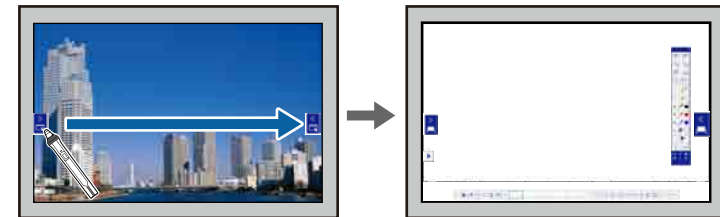

- You can also change the interactive mode by doing the following:
 - Pressing the [Pen Mode] button on the remote control.
 - Switching to **PC Free Annotation** or **PC Interactive** in the **Pen Mode** setting on the projector's **Extended** menu.
 - ☛ **Extended > Easy Interactive Function > Pen Mode**
 - You can switch to computer interactive mode when the image source is Computer, HDMI, USB Display or LAN.
 - You cannot switch to computer interactive mode when the **USB Type B** setting in the projector's **Extended** menu is set to **Wireless Mouse/USB Display**.
 - After changing to computer interactive mode, content drawn using annotation mode is retained.

If you have connected devices to the projector via a network, you can select to project an image from those devices. You can select the image source from computers that are running EasyMP Multi PC Projection, and smartphones or tablets that are running Epson iProjection.



You can select any connected network device for projection, even if the user connected using the EasyMP Multi PC Projection software with the moderator feature enabled. See the *EasyMP Multi PC Projection Operation Guide* for details about the moderator feature.

- 1 Select the  icon on the bottom toolbar, and then select **Participant List** from the image source list.

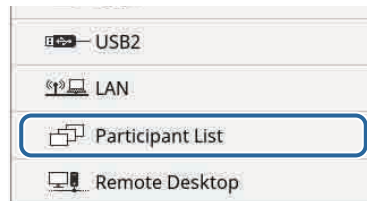

The user selection screen is displayed.

- 2 Select the user name for the device you want to project from.



- 1 Displays the user names for network devices connected to the projector.
The  icon is shown next to the user name of the currently projected device (Only when displaying pages with icons).
- 2 Closes the user selection screen and returns to the previous screen.
- 3 Click to move to the previous page or the next page when displaying a thumbnail.
- 4 Switches the display for the user selection screen between thumbnails or icons.
- 5 Refreshes the user selection screen.
When an additional user connects to the projector via a network, select this button to update the user list.



- On the user selection screen, you can use two pens or one finger at a time.
- While the user selection screen is displayed, you cannot do the following:
 - Select a different image source
 - Use other interactive features
 - Control the projector from the bottom toolbar
 - Connect to multiple projectors
 - Hear sound from the projector (it is turned off temporarily)
 - Project an image using EasyMP Multi PC Projection or Epson iProjection

You see the selected user's screen image.

When you change the user, repeat these steps.



- You cannot access the Participant List screen when connecting to multiple projectors by using EasyMP Multi PC Projection and projecting the same image (mirroring).
- If pen operations or touch operations do not work on the user selection screen, you can return to the previous screen by pressing the [Esc] button on the remote control or the control panel.

The remote desktop connection allows you to control a remote computer from the projected screen using the interactive pens or your finger (EB-1450Ui). You can also add notes to the projected content.

You can use the remote desktop connection through wired LAN and wireless LAN. Connection speed varies depending on the communication band of the network. We recommend using wired LAN for stable communication.



Make sure your computer is allowed to be controlled remotely. See your computer manual for details.

- 1 Select the  icon on the bottom toolbar, and then select **Remote Desktop** from the image source list.

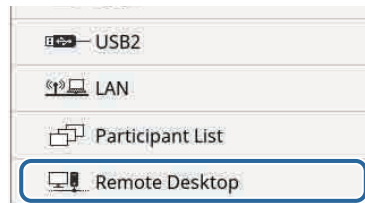

You can also select **Remote Desktop Connection** on the Home screen.

- 2 Select the following connection settings on the Remote Desktop Connection screen.

The screenshot shows the 'Remote Desktop' connection dialog box. It has four main input fields: 'Address', 'User name', 'Password', and 'Quality'. The 'Quality' field has two radio buttons: 'Priority to Quality' and 'Priority to Speed', with 'Priority to Speed' selected. At the bottom, there are three buttons: 'Connect', 'Defaults', and 'Cancel'. Numbered callouts 1 through 4 point to the Address, User name, Password, and Quality fields respectively.

- 1 Enter the remote computer's IP address or FQDN (Fully Qualified Domain Name) for the remote desktop connection. You can enter up to 64 alphanumeric characters. If you specify an FQDN, you must configure a DNS server. You can enter a port number by adding it after the IP address or the FQDN and separating them with a colon (IP address or FQDN:port number).
- 2 Enter a user name for the remote computer. You can enter up to 32 alphanumeric characters. You can enter a domain name by adding it before the user name and separating them with a backslash (domain\user name).
- 3 Enter a password for the remote computer. You can enter up to 32 alphanumeric characters.
- 4 Select the remote desktop connection speed/quality.
The projection resolution of the remote computer screen varies depending on the **Quality** settings:
 - Speed: WXGA
 - Quality: WUXGA



- You can use an external USB keyboard connected to the USB-A port on the control pad to enter numbers and characters. English keyboard (101 keyboard) is supported. Using the keyboard instead of the displayed keyboard allows you to enter a user name or password securely.
- While the Remote Desktop Connection screen is displayed, you cannot do the following:
 - Select a different image source
 - Use other interactive features
 - Control the projector from the bottom toolbar
 - Connect to multiple projectors
 - Hear sound from the projector (it is turned off temporarily)
- You can also set the default **Address**, **User name**, and **Password** using **Remote Desktop Setup** in the projector's **Network** menu.

3 Select **Connect**.

You see the remote computer's screen image.



- The remote computer's screen is displayed from the LAN source. To return to the remote computer's screen after switching to other sources, press the [LAN] button on the remote control.
- You can also use an external USB keyboard to enter numbers and characters during the remote desktop connection. You can change the keyboard layout in Windows. See Windows Help for details.

4 To switch to annotation mode, select the icon, and then select the



icon.



To close the remote desktop connection, select the  icon, **Remote Desktop Connection**, and then **Disconnect**.

» Related Links

- "Remote Desktop Connection System Requirements" [p.129](#)
- "Remote Desktop Connection Restrictions" [p.130](#)

Remote Desktop Connection System Requirements

Your computer must use one of the following operating systems to use the remote desktop connection.

Windows	Windows 7
	<ul style="list-style-type: none"> • Ultimate (32- and 64-bit) • Enterprise (32- and 64-bit) • Professional (32- and 64-bit)
	Windows 8
	<ul style="list-style-type: none"> • Windows 8 Pro (32- and 64-bit) • Windows 8 Enterprise (32- and 64-bit)
	Windows 8.1
	<ul style="list-style-type: none"> • Windows 8.1 Pro (32- and 64-bit) • Windows 8.1 Enterprise (32- and 64-bit)
Windows 10	
<ul style="list-style-type: none"> • Windows 10 Pro (32- and 64-bit) 	
Windows Server 2008 R2	
Windows Server 2012	

Remote Desktop Connection Restrictions

Functional restrictions

The following functions of the remote desktop connection are not supported.

- RD Gateway
- RemoteFX
- USB redirection
- Audio transfer

Operating restrictions

- You can only use one pen or one finger at a time.
- Touch operations are available when your computer supports it and your operating system is Windows 10, Windows 8.1, or Windows 8.
- Server authentication is not performed. Therefore, the server certificate is not verified.

You can use your projector in computer interactive mode over a network.

If you want to annotate when using computer interactive mode over a network, you need to use Easy Interactive Tools (or another annotation program). Easy Interactive Tools allows you to use various drawing tools, treat the drawing area as a page, and save your drawings as a file for a later use. You can install Easy Interactive Tools from the EPSON Projector Software for Easy Interactive Function CD. You can also download the software from the Epson website.

Use EasyMP Multi PC Projection version 2.10 or later (for Windows and OS X) to setup your projector on a computer network and use computer interactive mode over the network.

Select **Use Interactive Pen** on the **General settings** tab and **Transfer layered window** on the **Adjust performance** tab.

See the *EasyMP Multi PC Projection Operation Guide* for instructions.



- Number of pens or fingers (EB-1450Ui) you can use at the same time is as follows:
 - Windows: two pens and six fingers
 - OS X: one pen or one finger
- The response may be slower over the network.
- You cannot change the **Pen Operation Mode** setting from the projector's **Extended** menu.
- You can connect up to four projectors at one time using EasyMP Multi PC Projection. When connected to multiple projectors, computer interactive mode functions for any projector. Operations performed on one projector are reflected in other projectors.

» **Related Links**

- "Precautions when Connecting to a Projector on a Different Subnet" [p.131](#)

Precautions when Connecting to a Projector on a Different Subnet

Follow these precautions when you connect to a projector on a different subnet using EasyMP Multi PC Projection and use interactive features:

- Search for the projector on the network by specifying the projector's IP address. You cannot search for it by specifying the projector name.
- Make sure that you get an echo reply back from the network projector when sending an echo request by the ping command. When the Internet Control Message Protocol (ICMP) option is disabled on the router, you can connect to the projector at remote locations even if you cannot get the echo reply back.
- Make sure the following ports are opened.

Port	Protocol	Usage	Communication
3620	TCP/UDP	For connection and control	two-way
3621	TCP	For transferring images	two-way
3629	TCP	For controlling projector	two-way

- Make sure that the MAC address filtering and application filtering options are configured properly on the router.
- When bandwidth management is applied for communications between locations, and EasyMP Multi PC Projection goes over the controlled bandwidth, you may not be able to connect to the projector at remote locations.



Epson does not guarantee the connection to the projector on a different subnet using EasyMP Multi PC Projection even if you meet the above requirements. When considering the implementation, be sure to test the connection in your network environment.

If you are using Windows 10, Windows 8.1, Windows 8, Windows 7, or Windows Vista, you can use the pen input and Ink tools to add handwritten input and annotations to your work.

You can also use the pen input and Ink features over a network when you set the interactive features to be available on your network.

» **Related Links**

- "Enabling Windows Pen Input and Ink Features" [p.132](#)
- "Using Windows Pen Input and Ink Features" [p.133](#)

Enabling Windows Pen Input and Ink Features

If you want to use the pen input and Ink features in Windows 10, Windows 8.1, Windows 8, Windows 7, or Windows Vista, you need to adjust the pen settings in the projector's **Extended** menu.

- 1 Press the [Menu] button, select the **Extended** menu, and press the [Enter] button.

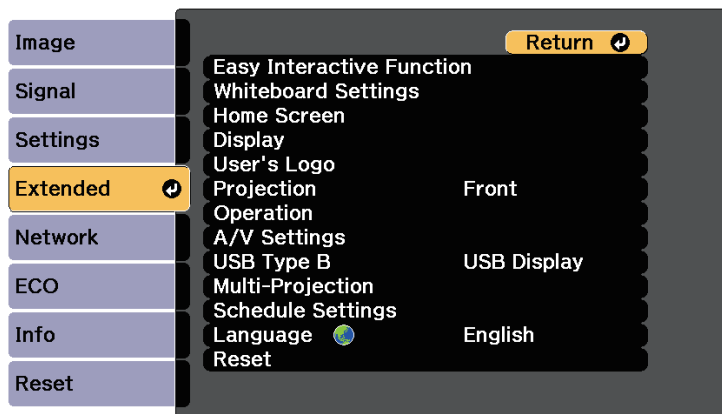

- 2 Select the **Easy Interactive Function** setting and press the [Enter] button.

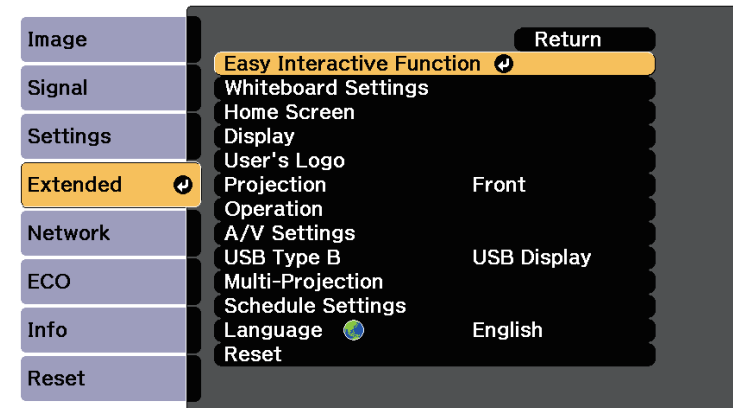

- 3 Select the **Pen Operation Mode** setting and press the [Enter] button.

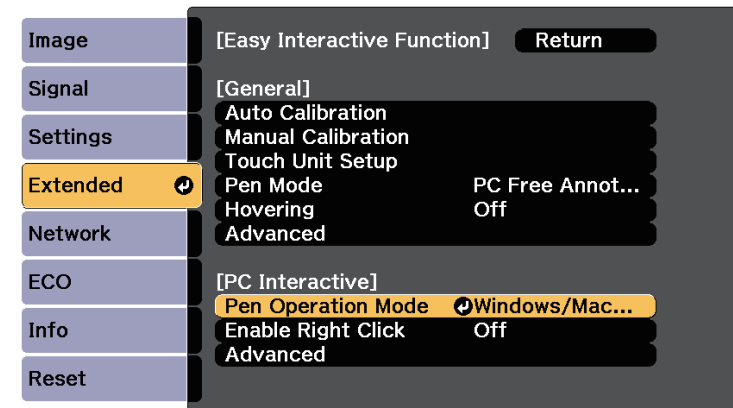

- 4 Select **Windows/Mac Mode** and press [Enter].

Using Windows Pen Input and Ink Features

If you are using Windows 10, Windows 8.1, Windows 8, Windows 7, or Windows Vista, you can add handwritten input and convert it to text.

If you have Microsoft Office 2007 or later, you can also use the Ink function to add handwritten notes to a Word document, Excel spreadsheet, or PowerPoint presentation.



Option names for the annotation functions may vary depending on your version of Microsoft Office.

- To open the Touch Keyboard in Windows 10, right-click or tap and hold on the Taskbar, then select **Show touch keyboard button**. Select the keyboard icon on the screen.
- To open the Touch Keyboard in Windows 8, right-click or tap and hold on the Taskbar, then select **Toolbars > Touch Keyboard**. Select the keyboard icon on the screen, then select the pen icon.
- To open the Tablet PC input panel in Windows 7 or Windows Vista, select  **> All Programs > Accessories > Tablet PC > Tablet PC Input Panel**.

You can write in the box using the pen or your finger (EB-1450Ui), then select from a variety of options to edit and convert the text.

- To add Ink annotations in Microsoft Office applications, select the **Review** menu, then select **Start Inking**.



In Microsoft Word or Excel, select the **Insert** tab and then click on **Start Inking**.

- To annotate your PowerPoint slides in Slideshow mode, press the button on the side of the pen or press the projection surface with your finger for about 3 seconds, then select **Pointer Options > Pen** from the pop-up menu.

For more information about these features, see your Windows Help.

You can simultaneously project images from two sources on the right and left of the screen, and use the interactive features.

When using annotation mode on both screens, you can write and draw across the screens.



- You can only use computer interactive mode on one of the screens.
- You can display the area where you can write and draw with a frame. When projecting two images simultaneously, press the [Menu] button and set the **Display Drawing Area** setting to **On**.
- The response time may be slower.





» Related Links

- "Switching Split Screen Projection" [p.134](#)
- "Selecting Split Screen Settings for the Interactive Feature" [p.135](#)
- "Projecting Two Images Simultaneously" [p.140](#)

Switching Split Screen Projection

You can split the screen to project two images simultaneously using the bottom toolbar or remote control. Follow the steps below to switch to the split screen projection using the bottom toolbar.



In whiteboard mode, you can also split the screen by tapping and dragging the  or  annotation mode tab. In annotation mode, you can also split the screen by tapping and dragging the  or  whiteboard mode tab.

1

Select the  icon on the bottom toolbar.



- 2 Select the input sources for the left and right screen.

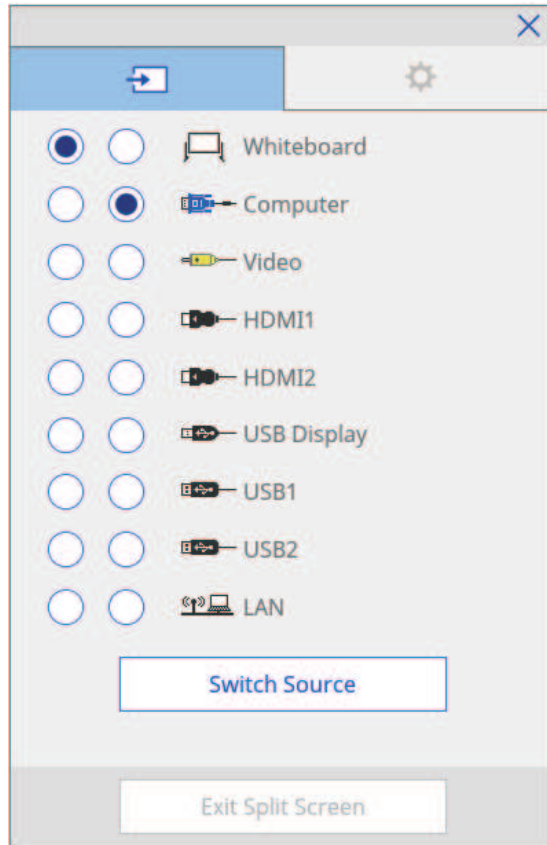



You can only select input sources that can be combined.

- 3 Select **Switch Source**.

Selecting Split Screen Settings for the Interactive Feature



Follow the steps below to select the split screen projection settings using the bottom toolbar.

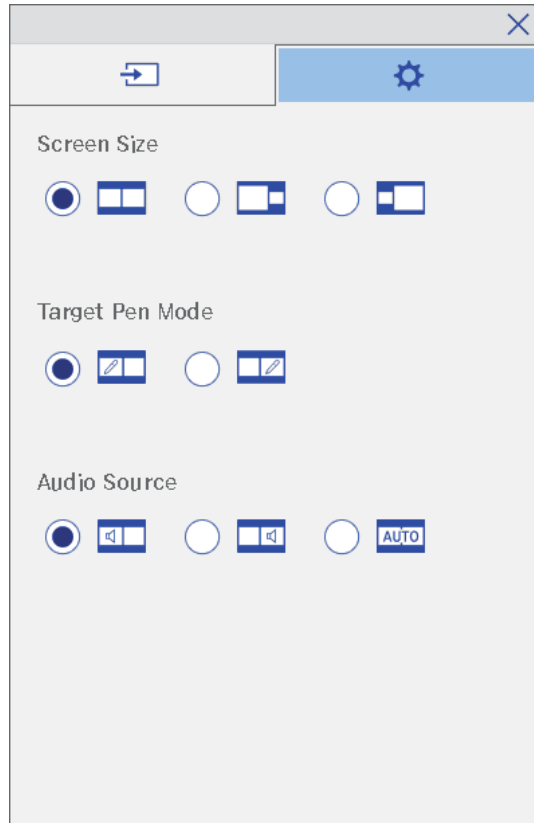

- 1 Select the  icon on the bottom toolbar.
The split screen setup screen is displayed.
- 2 Select the  tab.

3 Select the following split screen settings.



4 Select the  icon on the split screen setup screen to exit the screen.

 You can also tap and drag the  tab to enlarge one image while reducing the other image.

- **Screen Size:** enlarges one image while reducing the other image. Depending on the video input signals, the images may not appear at the same size even if you select  icon (**Equal**).
- **Target Pen Mode:** allows you to use the pen or your finger as a mouse on either screen.
- **Audio Source:** selects the audio. Select  icon (**Auto**) to hear audio from the larger screen or the left screen.

You can use your projector's interactive features while projecting with two projectors installed side by side. Install Easy Interactive Driver Ver. 4.0 from the Epson Projector Software for Easy Interactive Function CD-ROM.

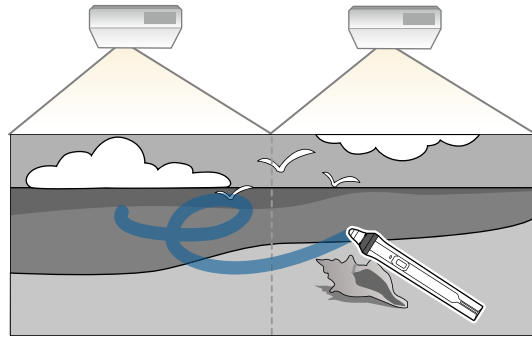

See the *Installation Guide* for detailed instructions on installing multiple projectors and making settings for the Interactive features.



You may not be able to write and draw across the border of the images.

» Related Links

- "Using the Interactive Features Temporarily on Only One of the Projectors" [p.137](#)
- "Using Multiple Projectors" [p.159](#)
- "Connecting Multiple Projectors of the Same Model" [p.40](#)

Using the Interactive Features Temporarily on Only One of the Projectors

When you are using the interactive features on a screen projected by two projectors, you can temporarily use the interactive features on only one of the projectors by selecting the following settings. This setting is only available on the Home screen.

- 1 Press the [Home] button on the remote control or the  icon on the bottom toolbar.

The Home screen appears.

- 2 Press the  icon.

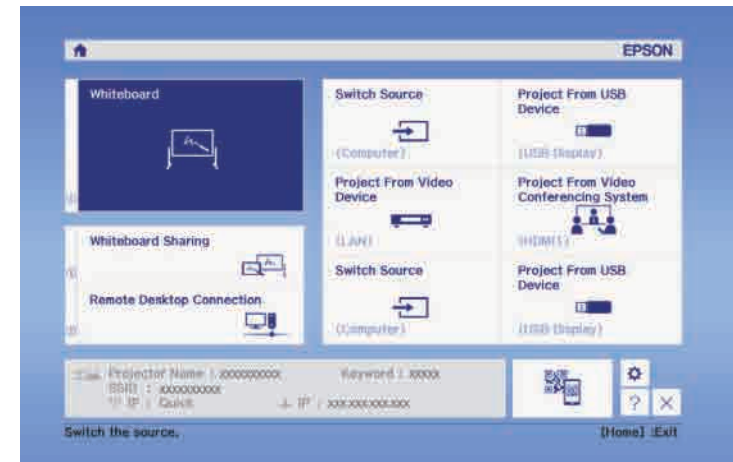

- 3** Select **On** for **Use this single projector**.

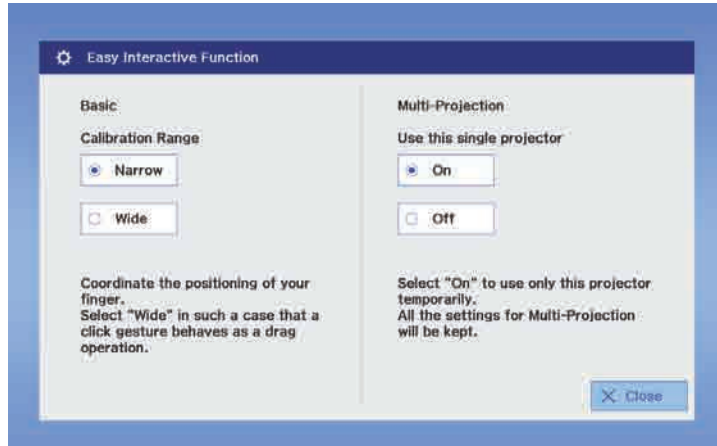

- 4** Press **Close** to return to the previous screen.
You can now temporarily use the interactive features using only one of the projectors.



When the projector turns off, the **Use this single projector** setting returns to **Off**.

Adjusting Projector Features

Follow the instructions in these sections to use your projector's adjustment features.

► Related Links

- "Projecting Two Images Simultaneously" [p.140](#)
- "Projecting a PC Free Presentation" [p.143](#)
- "Shutting Off the Image and Sound Temporarily" [p.150](#)
- "Stopping Video Action Temporarily" [p.151](#)
- "Zooming Images" [p.152](#)
- "Using the Remote Control as a Wireless Mouse" [p.153](#)
- "Using the Remote Control as a Pointer" [p.155](#)
- "Saving a User's Logo Image" [p.156](#)
- "Saving a User Pattern" [p.158](#)
- "Using Multiple Projectors" [p.159](#)
- "Projector Security Features" [p.167](#)

You can use the split screen feature to simultaneously project two images from different image sources. You can control the split screen feature using the remote control or the projector menus.

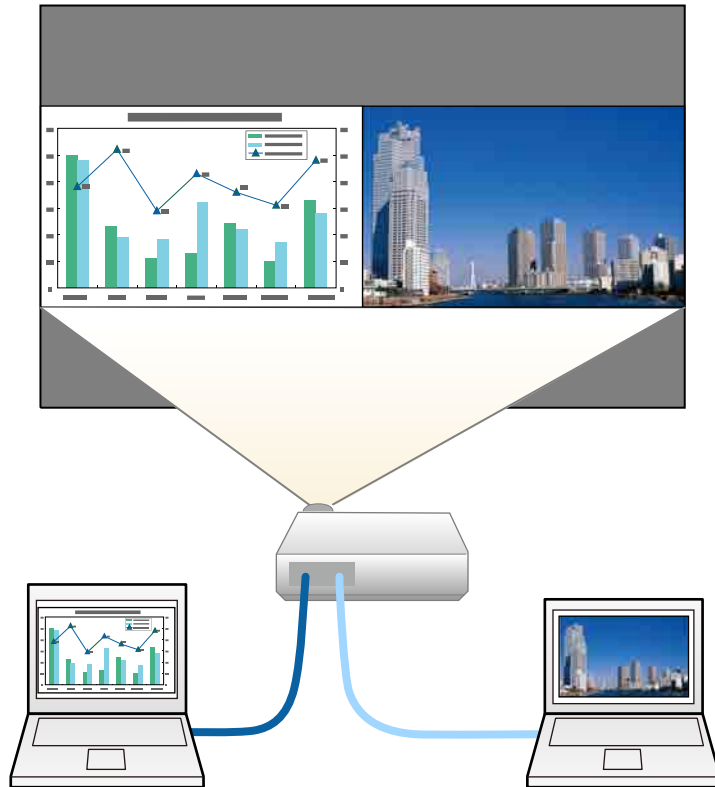

- While using the split screen feature, other projector features may not be available and some settings may be automatically applied to both images.

1 Press the [Split] button on the remote control.

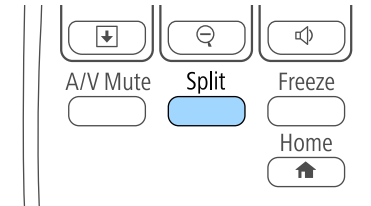

The currently selected input source moves to the left of the screen.



You can perform the same operations from **Split Screen** in the projector's **Settings** menu.

2 Press the [Menu] button.

You see this screen:

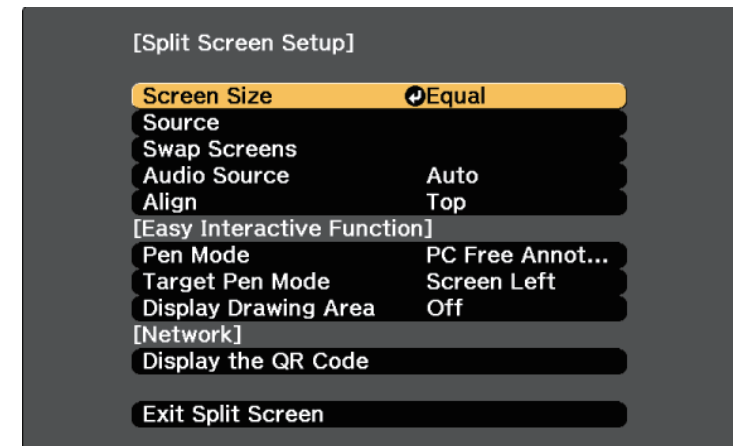

- 3** To select an input source for the other image, select the **Source** setting, press [Enter], select the input source, select **Execute**, and press [Enter].

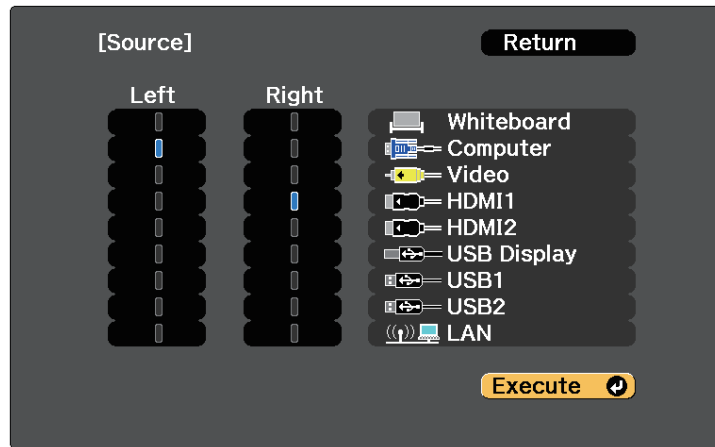

- You can only select input sources that can be combined.
- While using the split screen feature, the **Source** screen appears when you change the input source from the remote control.

- 4** To switch images, select **Swap Screens** and press [Enter].
The projected images on the left and right are swapped.



- 5** To enlarge one image while reducing the other image, select **Screen Size**, press [Enter], select a size, and press [Enter]. To exit the menu, press [Menu].



Depending on the video input signals, the images may not appear at the same size even if you select **Equal**.

- 6** To select the audio, select **Audio Source**, press [Enter], select an audio option, and press [Enter]. To exit the menu, press [Menu].



Select **Auto** to hear audio from the largest screen or the left screen.

- 7** To align the projected images to the top of the screen, select **Align**, press [Enter], select **Top**, and press [Enter] again. To exit the menu, press [Menu].

- 8** To exit the split screen feature, press [Split] or [Esc].

» Related Links

- "Unsupported Input Source Combinations for Split Screen Projection" [p.141](#)
- "Split Screen Projection Restrictions" [p.142](#)
- "Interactive Features when Projecting Two Images Simultaneously" [p.134](#)

Unsupported Input Source Combinations for Split Screen Projection

These input source combinations cannot be projected on a split screen.

- Computer and Video
- USB Display and USB1/USB2/LAN
- USB1/USB2 and LAN
- USB1 and USB2

Split Screen Projection Restrictions

Operating restrictions

The following operations cannot be performed during split screen projection.

- Setting the projector's menu
- E-Zoom
- Switching the aspect mode (the aspect mode is set to **Normal**)
- Operations using the [User] button on the remote control
- Auto Iris
- Light Optimizer
- Freeze (only when one of the screens is set to **Whiteboard**)

Image restrictions

- If you make adjustments such as **Brightness**, **Contrast**, **Color Saturation**, **Tint**, and **Sharpness** in the projector's **Image** menu, you can apply them only to the image on the left. Default adjustments are applied to the image on the right. Adjustments that affect the entire projected image such as **Color Mode** and **Color Temp.** are applied for both left and right images.
- Even if you make adjustments for **Noise Reduction** and **Deinterlacing** in the projector's **Image** menu, **Noise Reduction** is set to 0 and **Deinterlacing** is set to **Off** for the image on the right.
 - ☛ **Image > Image Enhancement > Noise Reduction**
 - ☛ **Image > Advanced > Deinterlacing**
- Even if you set **Display Background** to **Logo** in the projector's **Extended** menu, the blue screen appears when no image signal is being input.

» Related Links

- "Image Aspect Ratio" [p.70](#)
- "Color Mode" [p.72](#)
- "Input Signal Settings - Signal Menu" [p.208](#)
- "Projector Feature Settings - Settings Menu" [p.210](#)
- "Projector Setup Settings - Extended Menu" [p.213](#)
- "Zooming Images" [p.152](#)
- "Setting Auto Iris" [p.72](#)

You can use your projector's PC Free feature whenever you connect a USB device that contains compatible presentation files. This lets you quickly and easily display a presentation and control it using the projector's remote control.

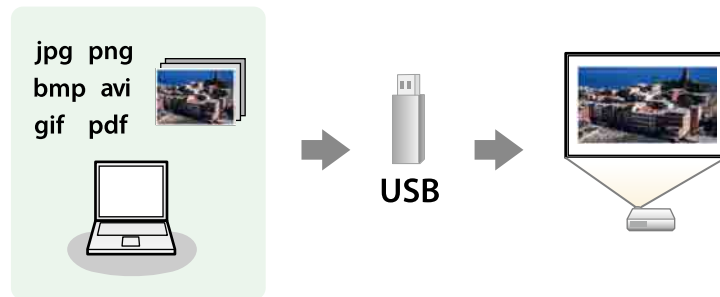

► **Related Links**

- "Supported PC Free File Types" [p.143](#)
- "Precautions on PC Free Projection" [p.143](#)
- "Starting a PC Free Slide Show" [p.144](#)
- "Starting a PC Free PDF File Presentation" [p.145](#)
- "Starting a PC Free Movie Presentation" [p.147](#)
- "PC Free Display Options" [p.148](#)

Supported PC Free File Types

You can project these types of files using the projector's PC Free feature.



- For best results, place your files on media that is formatted in FAT16/32.
- If you have trouble projecting from media formatted for non-Windows file systems, try formatting the media for Windows instead.

File contents	File type (extension)	Details
Image	.jpg	Make sure the file is not: <ul style="list-style-type: none"> • CMYK format • Progressive format • Highly compressed • Above 8192 × 8192 resolution
	.bmp	Make sure the file is not: <ul style="list-style-type: none"> • Above 1280 × 800 resolution
	.gif	Make sure the file is not: <ul style="list-style-type: none"> • Above 1280 × 800 resolution • Animated
	.png	Make sure the file is not: <ul style="list-style-type: none"> • Above 1920 × 1200 resolution
PDF	.pdf	Make sure the file is not: <ul style="list-style-type: none"> • Saved in PDF version 1.7 or later format • Encrypted
Movie	.avi (Motion JPEG)	Supports only AVI 1.0. Make sure the file is not: <ul style="list-style-type: none"> • Saved with an audio codec other than PCM or ADPCM • Above 1280 × 720 resolution • Larger than 2 GB

Precautions on PC Free Projection

Note the following precautions when using PC Free features.

- Do not disconnect the USB storage device while it is being accessed; otherwise, PC Free may not operate correctly.
- You may not be able to use the security features on certain USB storage devices with PC Free features.

- When connecting a USB device that includes an AC adapter, connect the AC adapter to an electrical outlet when you use the device with your projector.
- Some commercially available USB card readers may not be compatible with the projector.
- The projector can recognize up to 5 cards inserted into the connected card reader at one time.
- You cannot correct keystone distortion while projecting in PC Free, so correct the image shape before you begin your presentation.
- You can use the following functions while projecting in PC Free.
 - Freeze
 - A/V Mute
 - E-Zoom
 - Pointer

▶ Related Links

- "Stopping Video Action Temporarily" [p.151](#)
- "Shutting Off the Image and Sound Temporarily" [p.150](#)
- "Zooming Images" [p.152](#)
- "Using the Remote Control as a Pointer" [p.155](#)

Starting a PC Free Slide Show

After connecting a USB device to the projector, you can switch to the USB input source and start your slide show.



- You can also connect a USB device to the control pad.
- You can change the PC Free operation options or add special effects by highlighting **Option** at the bottom of the screen and pressing [Enter].
- You can operate your slide show using the interactive pen or your finger (EB-1450Ui) instead of the remote control.

- 1** Press the [Source Search] button on the remote control, control panel, or control pad. Select the **USB1** source.
The PC Free file list screen is displayed.



- If the Select Drive screen is displayed, press the arrow buttons to select the drive and press [Enter].
- To display images on the other USB drive, highlight **Select Drive** at the top of the file list screen and press [Enter].

- 2** Do one of the following to locate your files:
 - If you need to display files inside a subfolder on your device, press the arrow buttons to highlight the folder and press [Enter].
 - To move back up a folder level on your device, highlight **Back to Top** and press [Enter].
 - To view additional files in a folder, highlight **Next Page** or **Previous Page** and press [Enter], or press the [Page] up or down buttons on the remote control.

- 3** Do one of the following:
- To display an individual image, press the arrow buttons to highlight the image and press [Enter]. (Press the [Esc] button to return to the file list screen.)
 - To display a slide show of all the images in a folder, press the arrow buttons to highlight the **Slideshow** option at the bottom of the screen and press [Enter].

 • You can change the image switching time by highlighting **Option** at the bottom of the screen and pressing [Enter].

• If any file names are longer than the display area or include unsupported symbols, the file names may be shortened or changed only on the screen display.

- 4** While projecting, use the following commands to control the display:
- To rotate a displayed image, press the up or down arrow button.
- You can also rotate the image by flicking it using the interactive pen or your finger (EB-1450Ui).

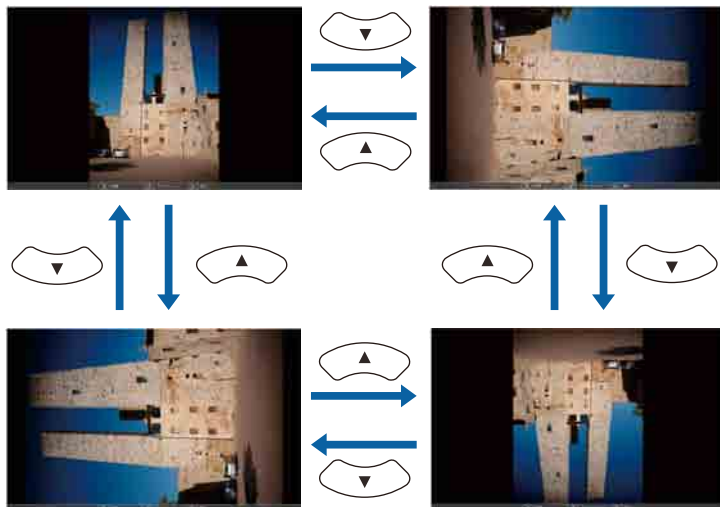

- To move to the next or previous image, press the left or right arrow button.
- You can also move forward or backward by flicking the image using the interactive pen or your finger (EB-1450Ui).

- 5** To stop the display, follow the on-screen instructions or press the [Esc] button.
- You return to the file list screen.

- 6** Turn off the USB device, if necessary, and then disconnect the device from the projector.

» **Related Links**

- "PC Free Display Options" [p.148](#)
- "Connecting to a USB Device" [p.35](#)

Starting a PC Free PDF File Presentation

After connecting a USB device to the projector, you can switch to the USB input source and start your PDF file presentation.

 • You can also connect a USB device to the control pad.

• You cannot do the following while presenting a PDF file from a USB device:

- Release a password
- Display e-signatures, JPEG2000 images, transparent effects, 3D artwork, or comments
- Play multimedia content
- Display encrypted PDF content
- Display a PDF file without a .pdf file extension

- 1** Press the [Source Search] button on the remote control, control panel, or control pad. Select the **USB1** source.

The PC Free file list screen is displayed.



-  • If the Select Drive screen is displayed, press the arrow buttons to select the drive and press [Enter].
- To display images on the other USB drive, highlight **Select Drive** at the top of the file list screen and press [Enter].

- 2** Do one of the following to locate your files:
 - If you need to display files inside a subfolder on your device, press the arrow buttons to highlight the folder and press [Enter].
 - To move back up a folder level on your device, highlight **Back to Top** and press [Enter].
 - To view additional files in a folder, highlight **Next Page** or **Previous Page** and press [Enter], or press the [Page] up or down buttons on the remote control.
- 3** Press the arrow buttons to highlight the file and press [Enter]. (Press the [Esc] button to return to the file list screen.)

The first page in the PDF file is displayed at full screen size.



-  If any file names are longer than the display area or include unsupported symbols, the file names may be shortened or changed only on the screen display.

- 4** While projecting a PDF file, use the following commands to control the display:
 - To move to the next or previous page, press the up or down arrow button.
You can also move forward or backward by flicking the page using the interactive pen or your finger (EB-1450Ui).
 - To display a menu of pages to select from, press the [Esc] button, press the left or right arrow button to select a page and press [Enter]. (If you press [Esc] while the select page menu is displayed, the menu closes.)

You can also display the menu of pages by tapping and holding it using the interactive pen or your finger (EB-1450Ui).

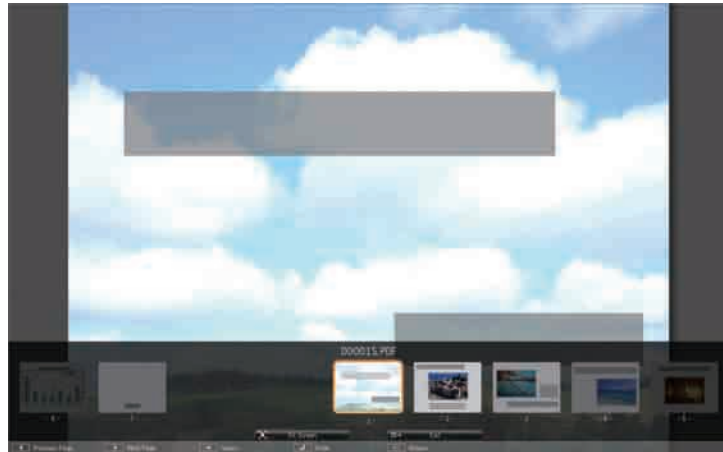

- To enlarge the view of a page to fit the screen, press [Enter]. Portrait pages are expanded horizontally to fit the width of the screen, and landscape pages are expanded vertically to fit the height of the screen. To scroll the page while a page is displayed at expanded size, press the arrow buttons. Press [Enter] again to return to standard size display.

You can also enlarge the view of the page by tapping it using the interactive pen or your finger (EB-1450Ui).

- To rotate a displayed page, press the left or right arrow button.
You can also rotate the page by flicking it using the interactive pen or your finger (EB-1450Ui).

5 To stop the display, press the [Esc] button, highlight **Exit**, and press [Enter].

6 Turn off the USB device, if necessary, and then disconnect the device from the projector.

Starting a PC Free Movie Presentation

After connecting a USB device to the projector, you can switch to the USB input source and start your movie.



- You can also connect a USB device to the control pad.
- You can change the PC Free operation options by highlighting **Option** at the bottom of the screen and pressing [Enter].

1 Press the [Source Search] button on the remote control, control panel, or control pad. Select the **USB1** source.

The PC Free file list screen is displayed.



- If the Select Drive screen is displayed, press the arrow buttons to select the drive and press [Enter].
- To display movie files on the other USB drive, highlight **Select Drive** at the top of the file list screen and press [Enter].

- 2** Do one of the following to locate your files:
- If you need to display files inside a subfolder on your device, press the arrow buttons to highlight the folder and press [Enter].
 - To move back up a folder level on your device, highlight **Back to Top** and press [Enter].
 - To view additional files in a folder, highlight **Next Page** or **Previous Page**, and press [Enter], or press the [Page] up or down buttons on the remote control.

- 3** To play back a movie, press the arrow buttons to highlight the file and press [Enter].



- If any file names are longer than the display area or include unsupported symbols, the file names may be shortened or changed only on the screen display.
- If you want to play back all the movies in a folder in sequence, select the **Slideshow** option at the bottom of the screen.

- 4** To stop movie playback, press the [Esc] button, highlight **Exit**, and press [Enter].

You return to the file list screen.

- 5** Turn off the USB device, if necessary, and then disconnect the device from the projector.

» **Related Links**

- "PC Free Display Options" [p.148](#)
- "Connecting to a USB Device" [p.35](#)

PC Free Display Options

You can select these display options when using PC Free. To access this screen, highlight **Option** at the bottom of the PC Free file list screen and press [Enter].



Setting	Options	Description
Display Order	Name Order	Displays files in name order
	Date Order	Displays files in date order
Sort Order	In Ascending	Sorts files in first-to-last order
	In Descending	Sorts files in last-to-first order
Continuous Play	On	Displays a slide show continuously
	Off	Displays a slide show once
Screen Switching Time	No	Does not display the next file automatically
	1 Second to 60 Seconds	Displays files for the selected time and switches to the next file automatically; high resolution images may switch at a slightly slower rate

Setting	Options	Description
Effect	No	No effect
	Wipe	Transitions between images using a wipe effect
	Dissolve	Transitions between images using a dissolve effect
	Random	Transitions between images using a random variety of effects

You can temporarily turn off the projected image and sound if you want to redirect your audience's attention during a presentation. Any sound or video action continues to run, however, so you cannot resume projection at the point that you stopped it.

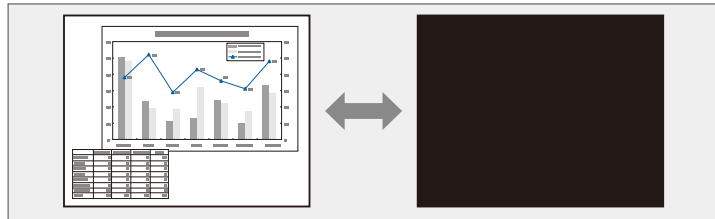

If you want to display an image such as a company logo or picture when the [A/V Mute] button is pressed, you can select the screen displayed in the **A/V Mute** setting in the projector's **Extended** menu.

☛ **Extended > Display > A/V Mute**

- 1** Press the [A/V Mute] button on the remote control to temporarily stop projection and mute any sound.

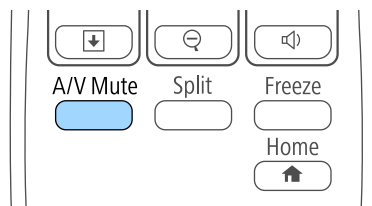

- 2** To turn the image and sound back on, press [A/V Mute] again.



- The projector's power automatically turns off 30 minutes after A/V Mute is enabled. You can disable this feature in the projector's **ECO** menu.
☛ **ECO > A/V Mute Timer**
- The lamp is still operating during A/V Mute, so the lamp hours continue to accumulate.

» Related Links

- "Projector Setup Settings - Extended Menu" [p.213](#)
- "Projector Setup Settings - ECO Menu" [p.233](#)

You can temporarily stop the action in a video or computer presentation and keep the current image on the screen. Any sound or video action continues to run, however, so you cannot resume projection at the point that you stopped it.

- 1** Press the [Freeze] button on the remote control to stop the video action.

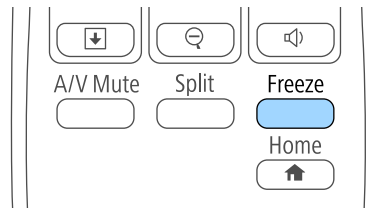

- 2** To restart the video action in progress, press [Freeze] again.

You can draw attention to parts of a presentation by zooming into a portion of the image and enlarging it on the screen.

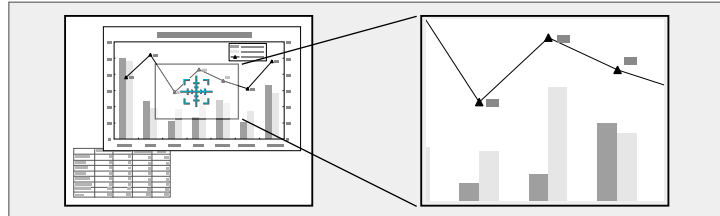

The enlarged image is projected and the enlargement ratio is displayed on the screen.

1 Press the [E-Zoom] + button on the remote control.

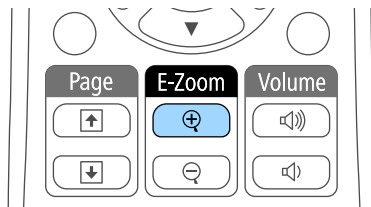

You see a crosshair on the screen indicating the center of the zoom area.

- 2** Use the following buttons on the remote control to adjust the zoomed image:
- Use the arrow buttons to position the crosshair in the image area you want to zoom into. To move the crosshair diagonally, press any pair of adjacent arrow buttons at the same time.
 - Press the [E-Zoom] + button repeatedly to zoom into the image area. Press and hold the [E-Zoom] + button to zoom in more quickly. The selected area can be enlarged to between one to four times in 25 incremental steps.
 - To pan around the zoomed image area, use the arrow buttons.
 - To zoom out of the image, press the [E-Zoom] – button.
 - To return to the original image size, press [Esc].

You can use the projector's remote control as a wireless mouse so you can control projection at a distance from the computer.



You can use the wireless mouse features with Windows Vista and later, or OS X 10.7.x and later.

- 1** Connect the projector to a computer using the projector's USB-B, Computer, or HDMI port.



The wireless mouse function does not work when projecting images from a device connected to the HDMI1/MHL port using an MHL cable.

- 2** If you connected your computer to the port other than the USB-B port, also connect a USB cable to the projector's USB-B port and to a USB port on your computer (for wireless mouse support).



You can connect your computer's USB cable to the control pad instead of directly to the projector.

- 3** Start your presentation.

- 4** Use the following buttons on the remote control to control your presentation:

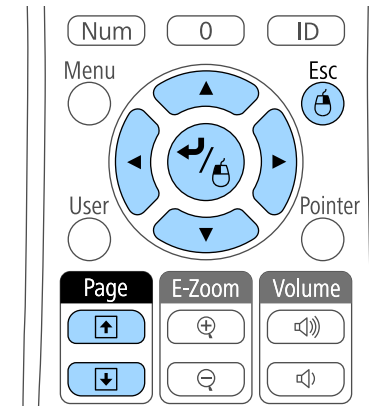

- To move through slides or pages, press the [Page] up or down buttons.
- To move the cursor on the screen, use the arrow buttons. To move the cursor diagonally, press any pair of adjacent arrow buttons at the same time.
- To left-click, press the [Enter] button once (press it twice to double-click). To right-click, press the [Esc] button.
- To drag-and-drop, hold the [Enter] button as you move the cursor with the arrow buttons, then release [Enter] at the destination.



- If the mouse button settings are set to reverse on the computer, the operation of the remote control buttons is also reversed.
- The Wireless Mouse function does not work under the following conditions:
 - When the projector's menu or a Help screen is displayed.
 - When **USB Type B** is set to **Easy Interactive Function** or **USB Display/Easy Interactive Function** from the projector's **Extended** menu.
 - When operating functions other than the Wireless Mouse function (such as adjusting the volume).
However, when using the E-Zoom or Pointer function, the page up or down function is available.

» Related Links

- "Zooming Images" [p.152](#)
- "Using the Remote Control as a Pointer" [p.155](#)

You can use the projector's remote control as a pointer to help you focus your audience on important information on the screen. The default pointer shape is an arrow. You can change the shape in the **Pointer Shape** setting in the projector's **Settings** menu.

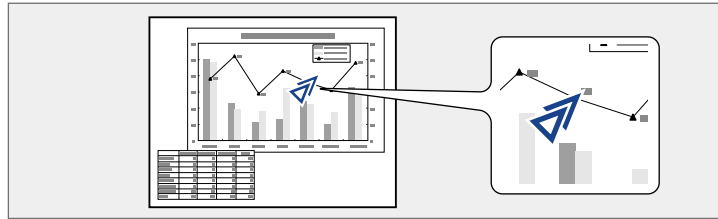

» Related Links

- "Projector Feature Settings - Settings Menu" [p.210](#)

- 1** Press the [Pointer] button on the remote control.

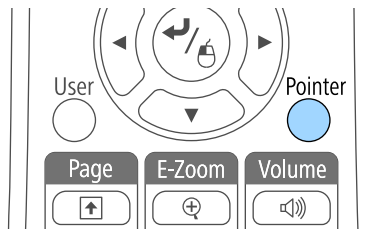

- 2** Use the arrow buttons to move the pointer on the screen. To move the pointer diagonally, press any pair of adjacent arrow buttons at the same time.

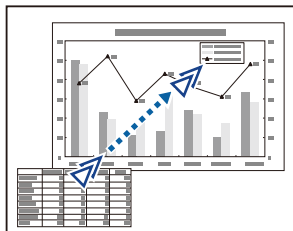

- 3** Press [Esc] to remove the pointer from the screen.

You can save an image on the projector and display it whenever the projector turns on. You can also display the image when the projector is not receiving an input signal or when you temporarily stop projection (using A/V Mute). This image is called the user's logo screen.

You can select a photo, graphic, or company logo as the user's logo, which is useful in identifying the projector's owner to help deter theft. You can prevent changes to the user's logo by setting up password protection.



- Once you save a user's logo, you cannot return to the factory default logo.
- If the **User's Logo Protection** setting is set to **On** in the **Password Protection** setting menu, set to **Off** before saving the user's logo.
- When you copy the menu settings from one projector to another using the batch setup feature, user's logo is also copied. Do not register the information that you do not want to share between multiple projectors as a user's logo.

- 1 Display the image you want to project as the user's logo.
- 2 Press the [Menu] button on the control panel or remote control.
- 3 Select the **Extended** menu and press [Enter].

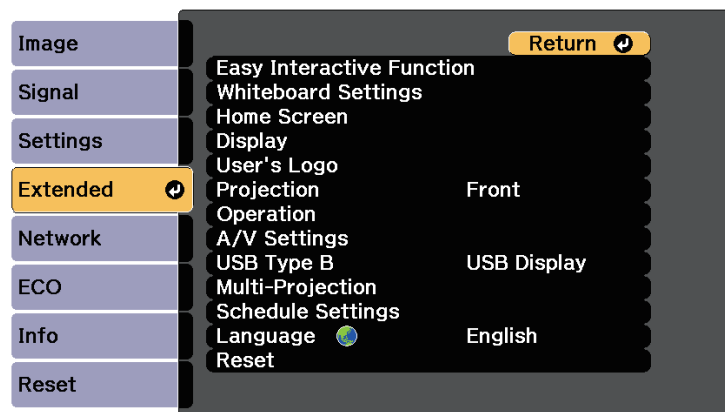

- 4 Select **User's Logo** and press [Enter].

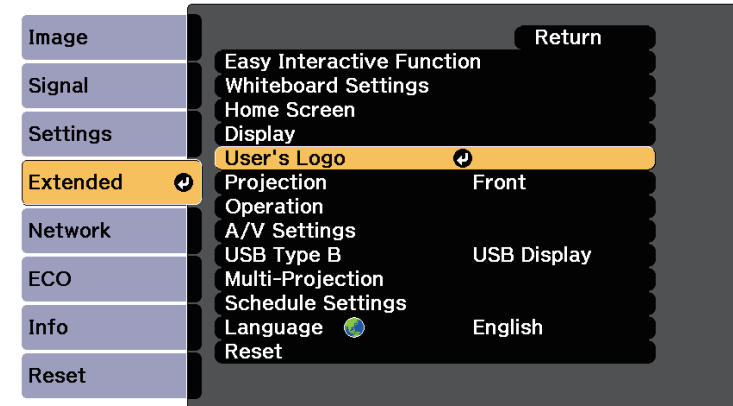

You see a prompt asking if you want to use the displayed image as a user's logo.



Adjustments such as Keystone, E-Zoom, or Aspect are temporarily canceled when you select **User's Logo**.

- 5 Select **Yes** and press [Enter].
You see a selection box overlaying your image.



Depending on the current image signal, the screen size may change to match the resolution of the image signal.

- 6** Use the arrow buttons to surround the image area you want to use as the user's logo and press [Enter].

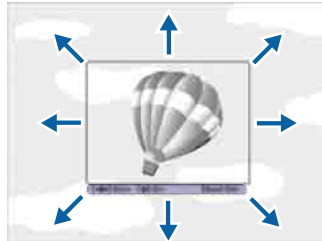

You see a prompt asking if you want to select this image area.



You cannot change the image area size (400 × 300 pixels).

- 7** Select **Yes** and press [Enter]. (If you want to change the selected area, select **No**, press [Enter], and repeat the last step.)

You see the User's Logo zoom factor menu.

- 8** Select a zoom percentage and press [Enter].

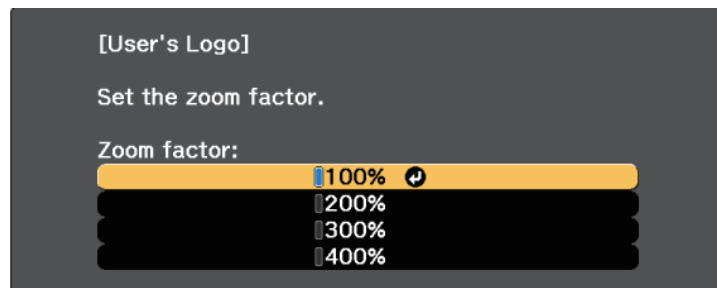

You see a prompt asking if you want to save the image as the user's logo.

- 9** Select **Yes** and press [Enter].
The user's logo is overwritten and a completion message appears.

- 10** Press [Esc] to exit the message screen.

- 11** Select the **Extended** menu and press [Enter].

- 12** Select **Display** and press [Enter].

- 13** Select when you want to display the User's Logo screen:
- To display it whenever there is no input signal, select **Display Background** and set it to **Logo**.
 - To display it whenever you turn the projector on, select **Startup Screen** and set it to **On**.
 - To display it whenever you press the [A/V Mute] button, select **A/V Mute** and set it to **Logo**.

To prevent anyone from changing the User's Logo settings without first entering a password, set the **User's Logo Protection** setting to **On** in the **Password Protection** setting menu and set the password.

» Related Links

- "Shutting Off the Image and Sound Temporarily" [p.150](#)
- "Selecting Password Security Types" [p.168](#)

There are four types of patterns pre-registered in the projector, such as ruled lines and grid patterns. You can project these patterns to aid in presentations using the **Pattern Display** settings in the **Settings** menu.

You can also save the image that is currently being projected as a User Pattern.

 Once you save a User Pattern, the pattern cannot be returned to the factory default.

1 Project the image you want to save as the User Pattern, and then press the [Menu] button on the control panel or remote control.

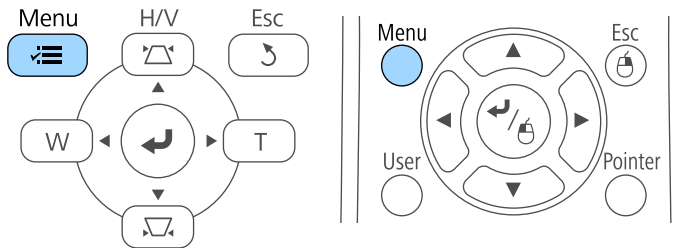

2 Select the **Settings** menu and press [Enter].

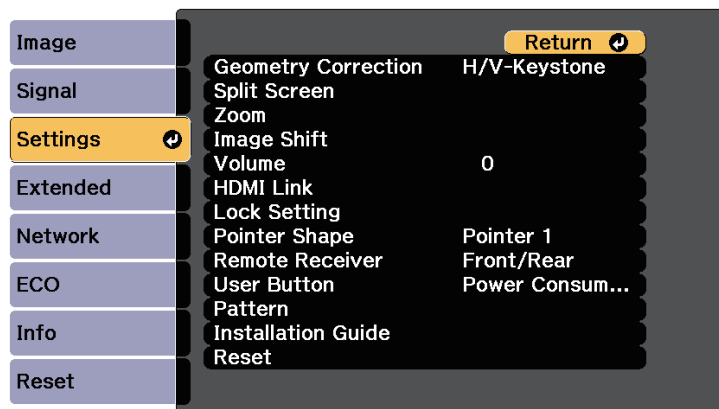

3 Select **Pattern** and press [Enter].

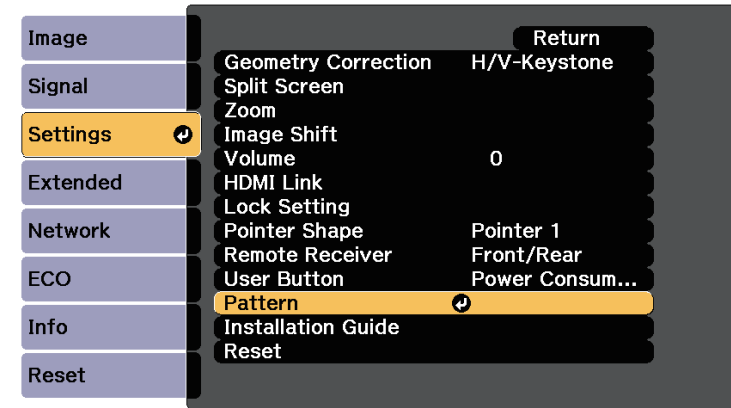

4 Select **User Pattern** and press [Enter].

You see a prompt asking if you want to use the displayed image as a User Pattern.

 Adjustments such as Keystone, E-Zoom, Aspect, Adjust Zoom, or Image Shift are temporarily cancelled when you select **User Pattern**.

5 Select **Yes** and press [Enter].

You see a prompt asking if you want to save the image as the User Pattern.

6 Select **Yes** and press [Enter].

You see a completion message.

You can combine the projected images from two or more projectors to create one large image.

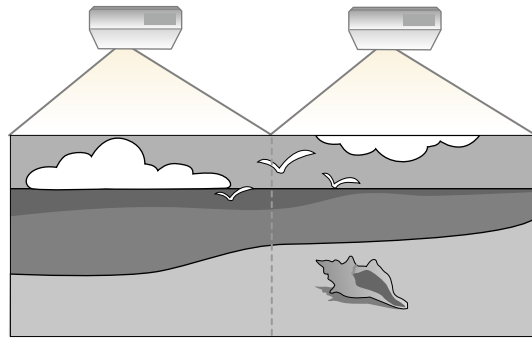

- Before starting projection, make sure you set **Multi-Projection** to **On** for all of the projectors.
 - ☛ **Extended** > **Multi-Projection** > **Multi-Projection**
- Before starting projection, make sure you select the same color mode for all of the projectors.
 - ☛ **Extended** > **Multi-Projection** > **Color Mode**

» Related Links

- "Projector Identification System for Multiple Projector Control" [p.159](#)
- "Adjusting Color Uniformity" [p.161](#)
- "Adjusting the Lamp's Brightness" [p.163](#)
- "Matching the Image Colors" [p.164](#)
- "Adjusting RGBCMY" [p.165](#)

Projector Identification System for Multiple Projector Control

When lining up multiple projectors to project images, you can correct the brightness and color tone of each projector's image so that the images match closely.

You can set a unique projector ID for each projector to operate them individually using a remote control, and then correct the brightness and color for each projector.



- In some cases the brightness and color tone may not match completely even after correction.
- If brightness and color tone differences become more noticeable over time, repeat the adjustments.

» Related Links

- "Setting the Projector ID" [p.159](#)
- "Selecting the Projector You want to Operate" [p.160](#)

Setting the Projector ID

To control multiple projectors from a remote control, give each projector a unique ID.

- 1** Press the [Menu] button on the control panel or remote control.
- 2** Select the **Extended** menu and press [Enter].
- 3** Select **Multi-Projection** and press [Enter].
- 4** Select **Projector ID** and press [Enter].

- Use the arrow buttons to select the identification number you want to use for the projector. Then press [Enter].

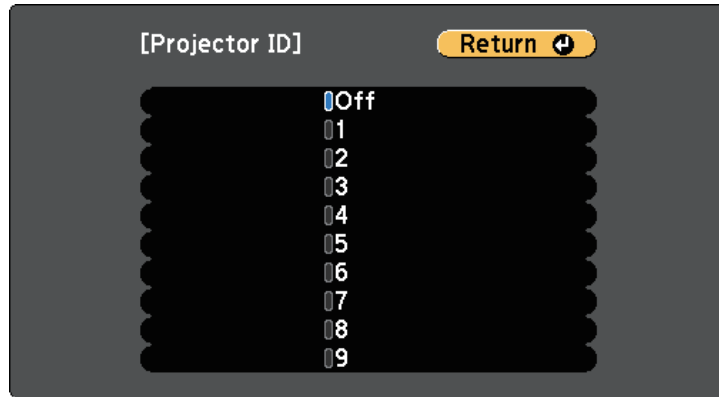

- Press [Menu] or [Esc] to exit the menus.

Repeat these steps for all the other projectors you want to operate from one remote control.

Selecting the Projector You want to Operate

After setting the projector's ID, select the ID for the projector you want to operate using the remote control.

- Aim the remote control at the target projector and press the [ID] button.

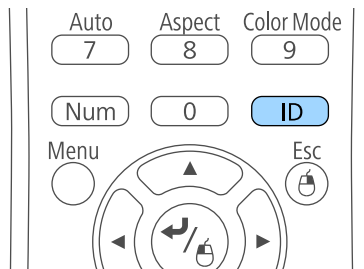

The current Projector ID is displayed on the projected screen. It disappears after about 3 seconds.

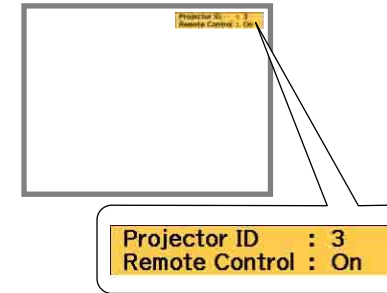

- While holding the [ID] button, press the number button that matches the ID of the projector you want to operate.

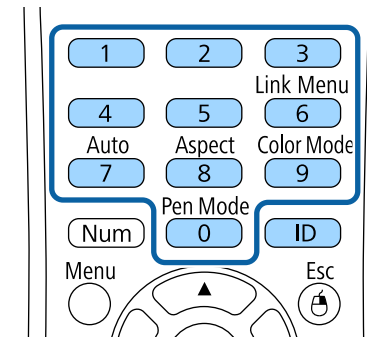

The projector you want to operate is selected.

- Press the [ID] button to check if the ID-setting process worked. You see a message displayed by the projector.

- If the remote control is listed as **On**, you can operate the projector from the remote control.

- If the remote control is listed as **Off**, you cannot operate the projector from the remote control. Repeat the steps above to enable the remote control.



- When you select 0 on the remote control, you can operate all projectors regardless the Projector ID setting.
- You must select the projector ID from the remote control each time you turn on the projector you have set it to control. When you turn on the projector, 0 is selected as the remote control's projector ID.
- When you set the **Projector ID** setting to **Off**, you can operate the projector using the remote control whichever ID you select on the remote control.

Adjusting Color Uniformity

If the color tone on the projected screen is uneven in each projector, adjust the color tone balance using each projector's **Extended** menu.



- The color tone may not be uniform even after performing color uniformity.
- When the Color Mode is set to **Dynamic**, this function is disabled.
 🖱️ **Image > Color Mode**

- 1 Press the [Menu] button, select the **Extended** menu, and press [Enter].

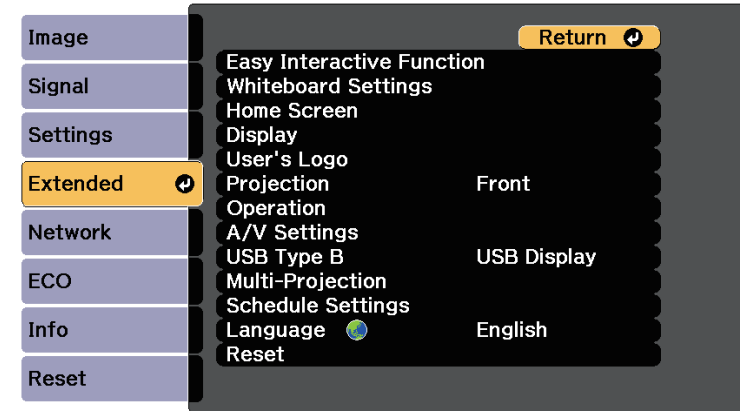

- 2 Select **Multi-Projection** and press [Enter].

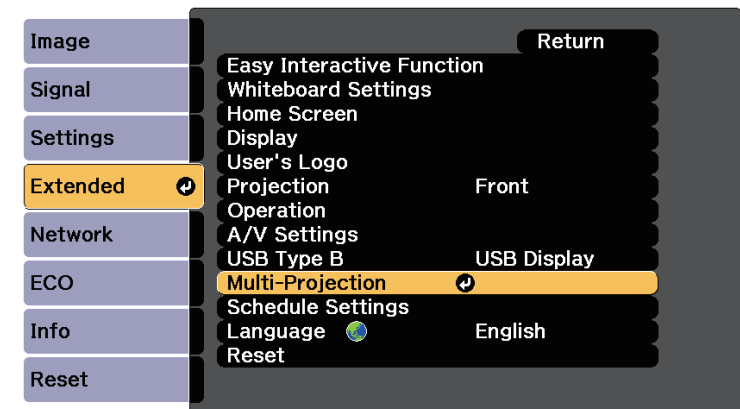

3 Select **Color Uniformity** and press [Enter].

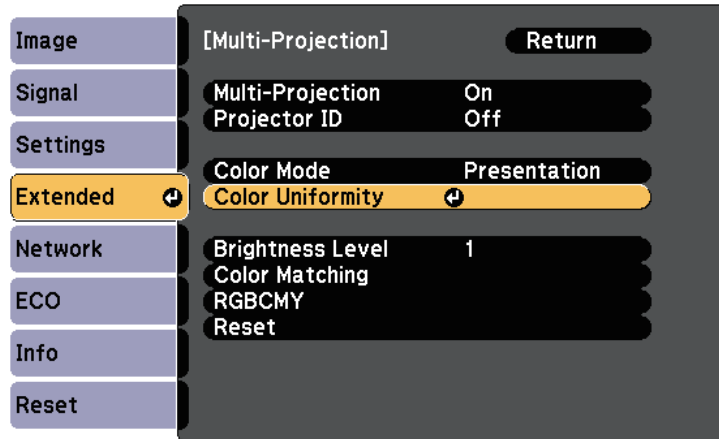

4 Select **Color Uniformity** and press [Enter].

5 Select **On** and press [Enter]. Then press [Esc].

6 Select **Adjustment Level** and press [Enter].



7 Select the level and press [Esc].



8 Select **Start Adjustments** and press [Enter].

9 Select the area you want to adjust, and press [Enter].

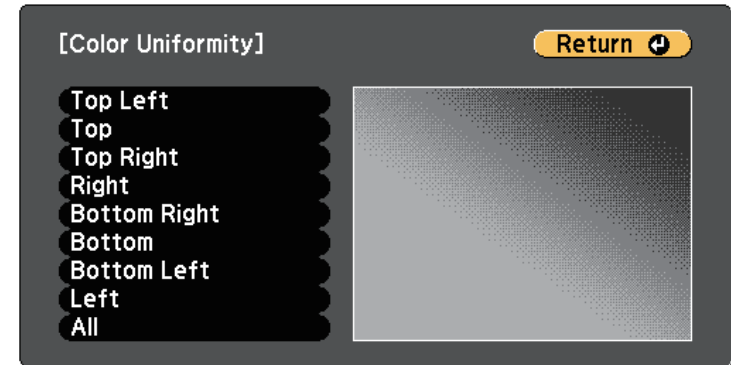

Adjust the circumference first. Finally select **All**, and then adjust the whole screen.

10 Select the color (**Red**, **Green**, or **Blue**) you want to adjust, and use the left arrow button to weaken the color tone and the right arrow button to strengthen the color tone.

 The adjustment screen changes each time you press [Enter].

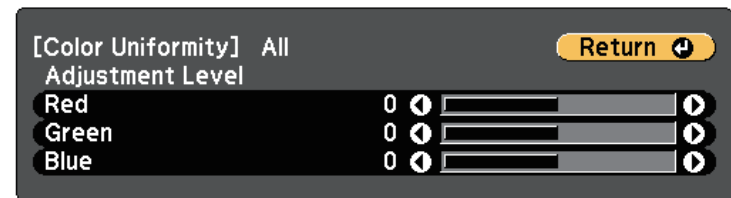

11 Press [Esc] to return to the area selection screen.

12 Repeat these steps to adjust each area.

13 Press [Esc] to return to the previous screen.

Adjusting the Lamp's Brightness

When projecting with multiple projectors, you must adjust the brightness setting for each projector.

Turn on all the projectors and select the **Brightness Level** setting in each projector's **Extended** menu so that all the projectors are as bright as the darkest lamp on the combined screen.



- Even after adjusting the brightness levels, the brightness of each lamp may not match exactly.
- This function is only available when **Power Consumption** is set to **Normal**.
 ⏪ **ECO > Power Consumption**

1 Press the [Menu] button, select the **Extended** menu, and press [Enter].

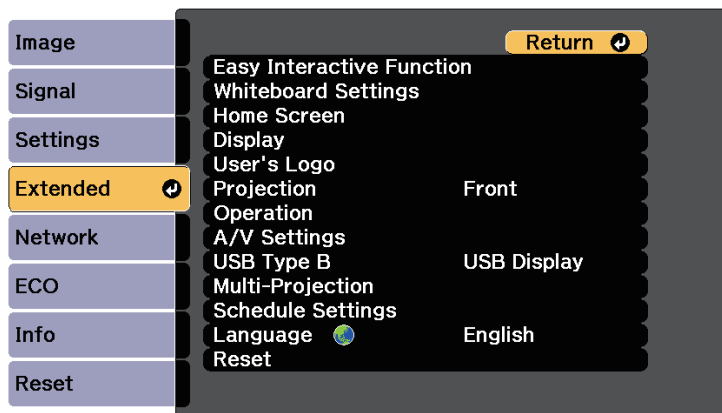

2 Select **Multi-Projection** and press [Enter].

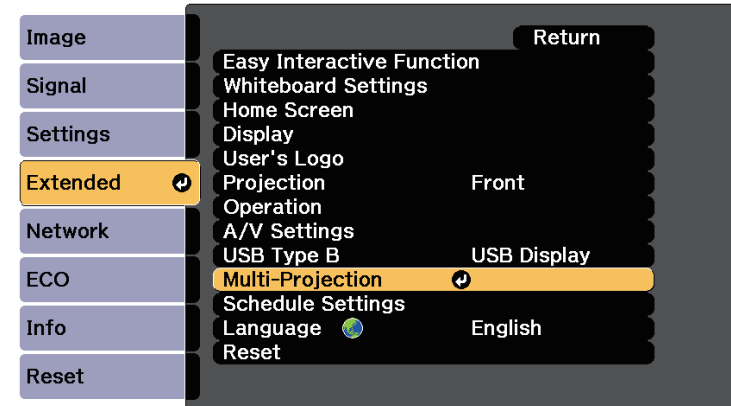

3 Select **Brightness Level** and press [Enter].

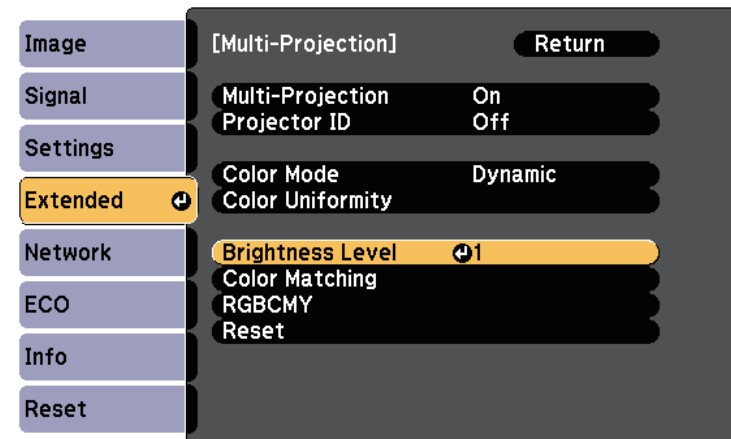

4 Select the brightness level, and press [Enter].

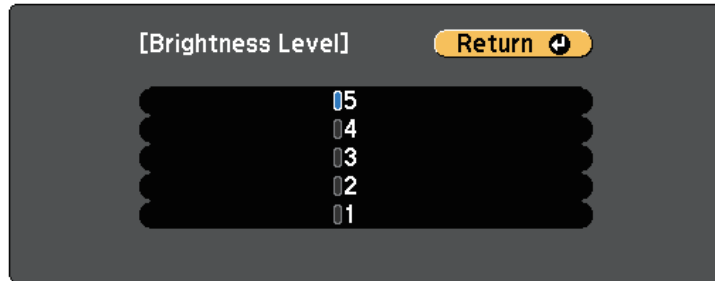

5 Press [Esc] to return to the previous screen.

Matching the Image Colors

You can match the display quality of multiple projectors that will project next to each other.

Turn on all the projectors and select the **Color Matching** setting in each projector's **Extended** menu so that all the projectors' display quality match on the combined screen.

1 Press the [Menu] button, select the **Extended** menu, and press [Enter].

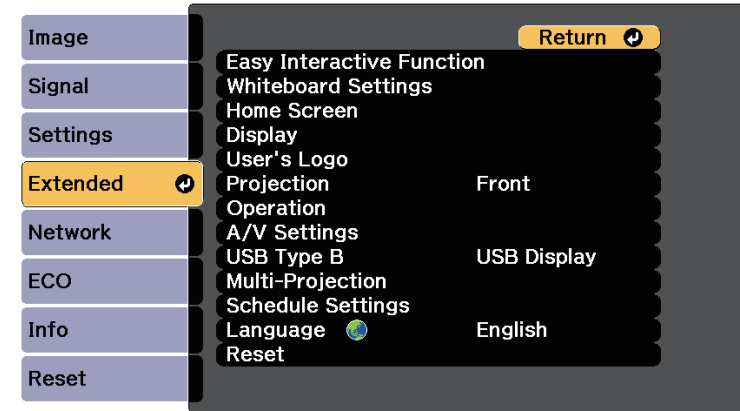

2 Select **Multi-Projection** and press [Enter].

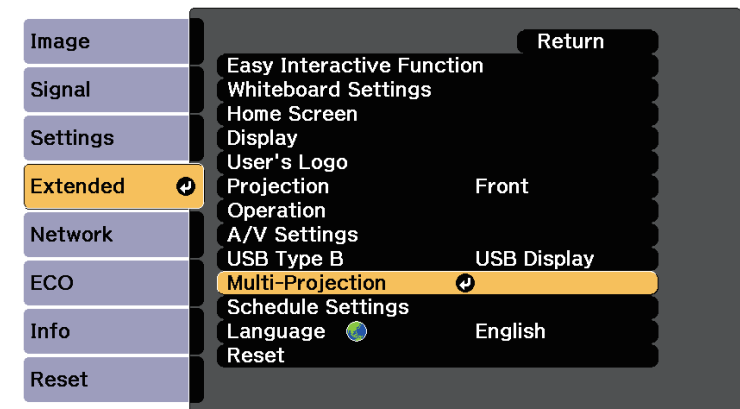

3 Select **Color Matching** and press [Enter].

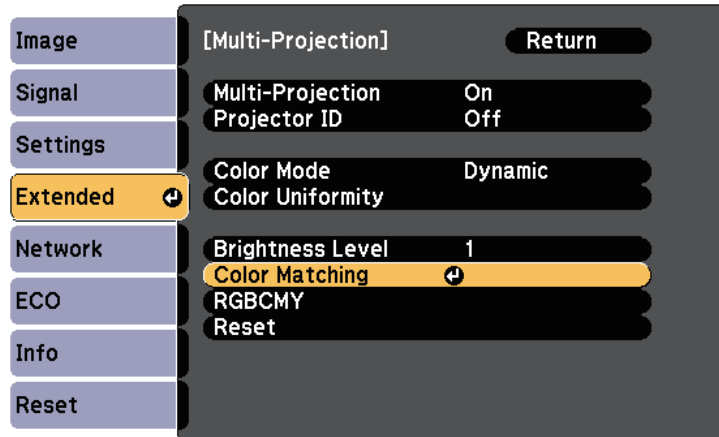

4 Select **Adjustment Level**.

There are six adjustment levels from white through gray, and up to black. You can adjust each level individually.

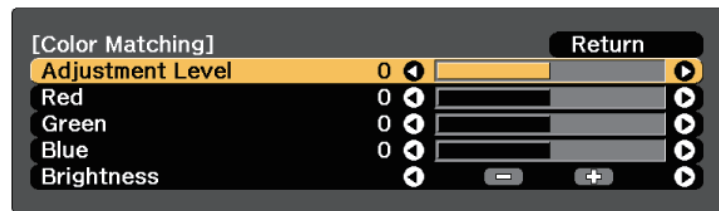

5 Select **Red**, **Green**, or **Blue**, and adjust the color tone.

6 Select **Brightness**, and adjust the value.

7 Return to step 4 and adjust another level.

8 Press the [Esc] button to return to the previous screen.

Adjusting RGBCMY

You can adjust the **Hue**, **Saturation**, and **Brightness** settings for R (red), G (green), B (blue), C (cyan), M (magenta), and Y (yellow) color components.

Turn on all the projectors and select the **RGBCMY** setting in each projector's **Extended** menu so that the color tone on the combined screen becomes entirely even.

1 Press the [Menu] button, select the **Extended** menu, and press [Enter].

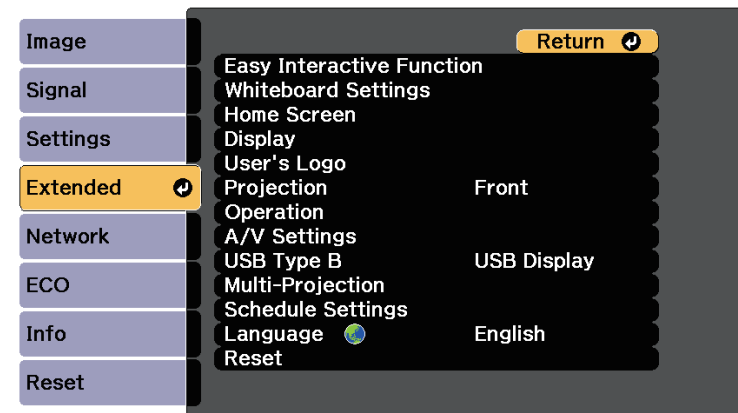

2 Select **Multi-Projection** and press [Enter].

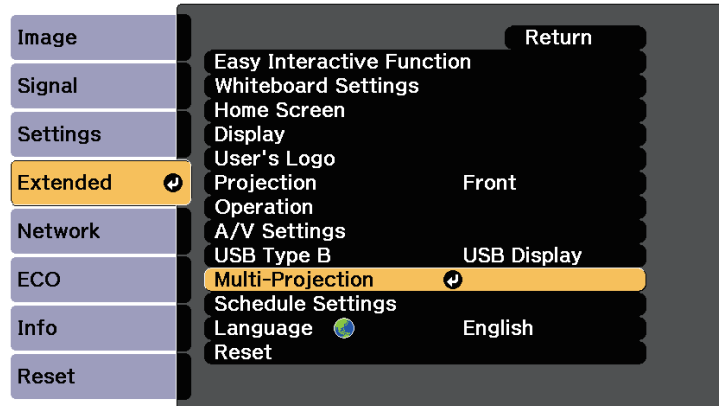

- To adjust the overall vividness of the color, adjust the **Saturation** setting.
- To adjust the overall color brightness of the color, adjust the **Brightness** setting.

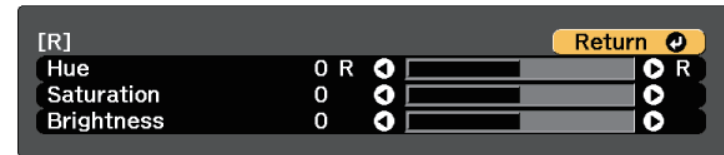

6 Press [Menu] or [Esc] to exit the menus.

3 Select **RGBCMY** and press [Enter].

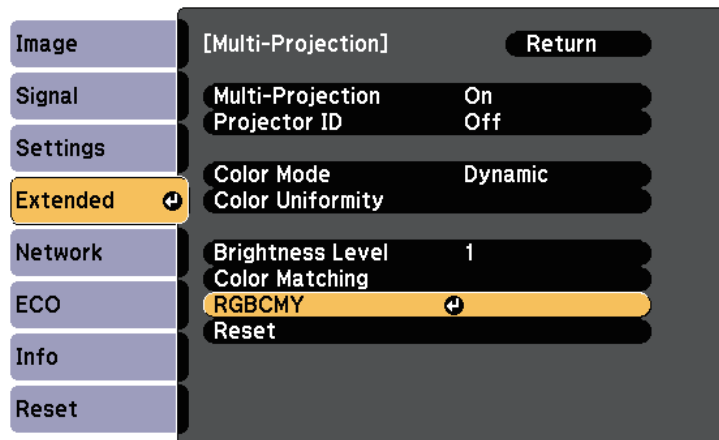

4 Select the color to adjust, and press [Enter].

5 Do the following as necessary for each setting:

- To adjust the overall hue of the color, bluish - greenish - reddish, adjust the **Hue** setting.

You can secure your projector to deter theft or prevent unintended use by setting up the following security features:

- **Password security** to prevent people who do not know the password from using the projector, and prevent changes to the startup screen and other settings.
This acts as an anti-theft function as the projector cannot be used even if it is stolen, and you can limit who can use the projector.
- **Button lock security** to block operation of the projector using the buttons on the control panel.
This is useful at events or shows when you want to deactivate all buttons during projection or at schools when you want to limit button operation.
- **Security cabling** to physically secure the projector in place.

► Related Links

- "Password Security Types" [p.167](#)
- "Locking the Projector's Buttons" [p.169](#)
- "Installing a Security Cable" [p.171](#)

Password Security Types

You can set up the following types of password security using one shared password:

- **Power On Protection** password prevents anyone from using the projector without first entering a password. When plugging the power cord and turning on the projector at first time, you must enter the correct password. This also applies to Direct Power On and Auto Power On.
- **User's Logo Protection** password prevents anyone from changing the custom screen displayed when the projector turns on, when no signal is being input, or when you use the A/V Mute feature. The custom screen discourages theft by identifying the projector's owner.
- **Network Protection** password prevents anyone from changing the projector's **Network** settings.
- **Schedule Protection** password prevents anyone from changing the projector's schedule settings.

- **Whiteboard Protection** password prevents anyone from changing the projector's **Whiteboard Settings**.

► Related Links

- "Setting a Password" [p.167](#)
- "Selecting Password Security Types" [p.168](#)
- "Entering a Password to Use the Projector" [p.169](#)

Setting a Password

To use password security, you must set a password.



The default password is set to "0000". Change this to your own password.

1

Hold down the [Freeze] button on the remote control for about 5 seconds.

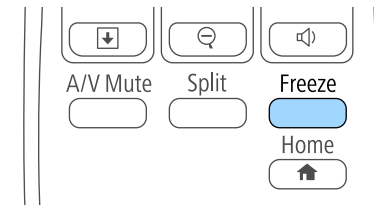

You see the Password Protection setting menu.



If Password Protection is already activated, you must enter the correct password to display the Password Protection setting menu.

- 2 Select **Password** and press [Enter].

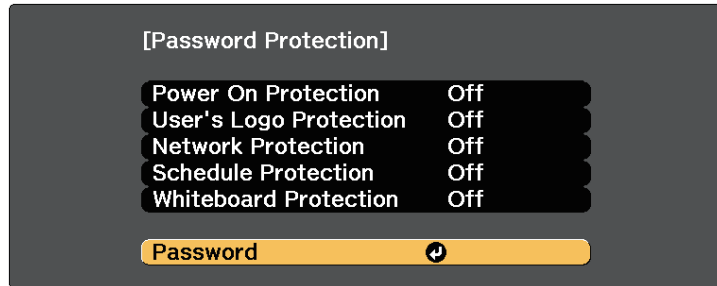

You see the prompt "Change the password?".

- 3 Select **Yes** and press [Enter].

 If you select **No**, the Password Protection setting menu is displayed again.

- 4 Hold down the [Num] button on the remote control and use the numeric buttons to set a four-digit password.

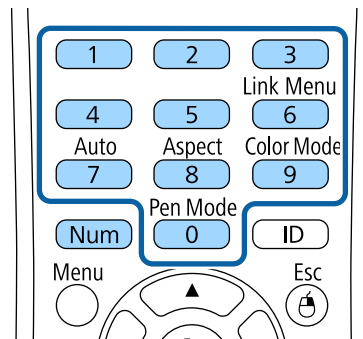

The password displays as **** as it is entered. A confirmation prompt is displayed when you enter the fourth digit.

- 5 Enter the password again.
You see the message "Password accepted". If you enter the password incorrectly, a message is displayed prompting you to re-enter the password.
- 6 Press [Esc] to return to the menu.
- 7 Make a note of the password and keep it in a safe place.

Selecting Password Security Types

After setting a password, you see this menu, allowing you to select the password security types you want to use.

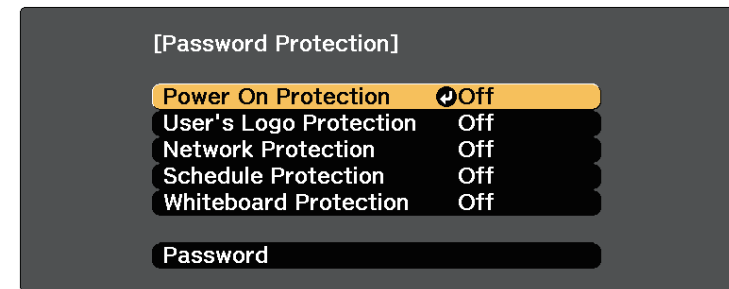

If you do not see this menu, hold down the [Freeze] button on the remote control for 5 seconds until the menu appears.

- To prevent unauthorized use of the projector, select **On** as the **Power On Protection** setting.
- To prevent changes to the User's Logo screen or related display settings, select **On** as the **User's Logo Protection** setting.
- To prevent changes to network settings, select **On** as the **Network Protection** setting.
- To prevent changes to the projector's schedule settings, select **On** as the **Schedule Protection** setting.

- To prevent changes to the projector's **Whiteboard Settings**, select **On** as the **Whiteboard Protection** setting.

You can attach the password protect sticker to the projector as an additional theft deterrent.

 Be sure to keep the remote control in a safe place; if you lose it, you will not be able to enter the password.

Entering a Password to Use the Projector

When the password screen is displayed, enter the correct password.

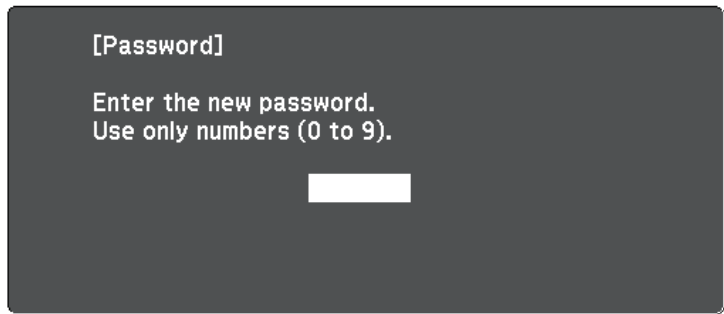

- 1** Hold down the [Num] button on the remote control while you enter the password using the numeric buttons.

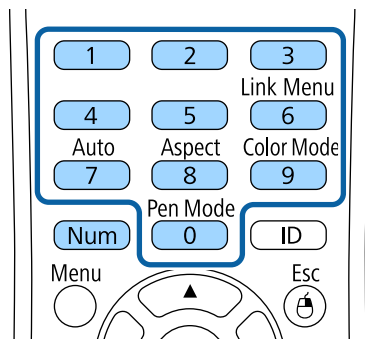

The password screen closes.

- 2** If the password is incorrect, you see a message and a prompt to try again. Enter the correct password to proceed.

Attention

- If an incorrect password is entered three times in succession, the message "The projector's operation will be locked." is displayed for approximately 5 minutes, and the projector switches to standby mode. If this happens, disconnect the power plug from the electrical outlet, reinsert it, and turn the projector back on. The projector displays the password entry screen again so that you can enter the correct password.
- If you have forgotten the password, make a note of the "**Request Code:** xxxxx" number that appears on the screen and contact Epson for help.
- If you continue to repeat the above operation and input the wrong password 30 times in succession, the message "The projector's operation will be locked. Contact Epson as described in your documentation." is displayed and the projector does not accept any more password entries. Contact Epson for help.

Locking the Projector's Buttons

You can lock the buttons on the control panel to prevent anyone from using the projector. The projector can still be operated using the remote control.

- 1** Press the [Menu] button on the control panel or remote control.

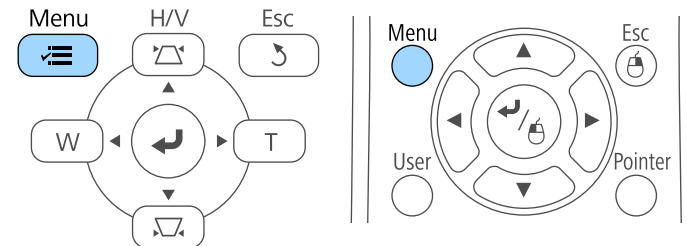

2 Select the **Settings** menu and press [Enter].

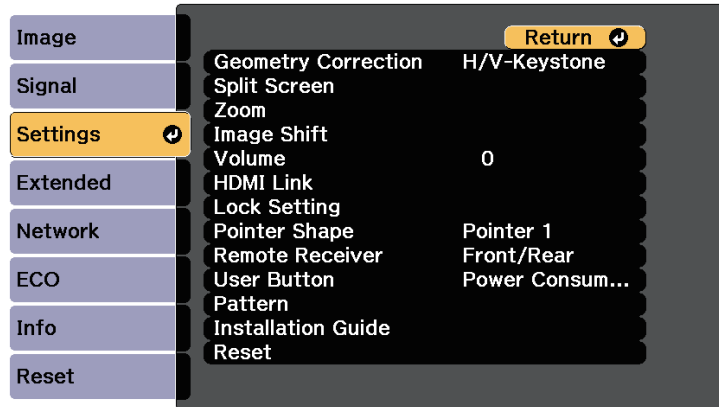

3 Select **Lock Setting** and press [Enter].

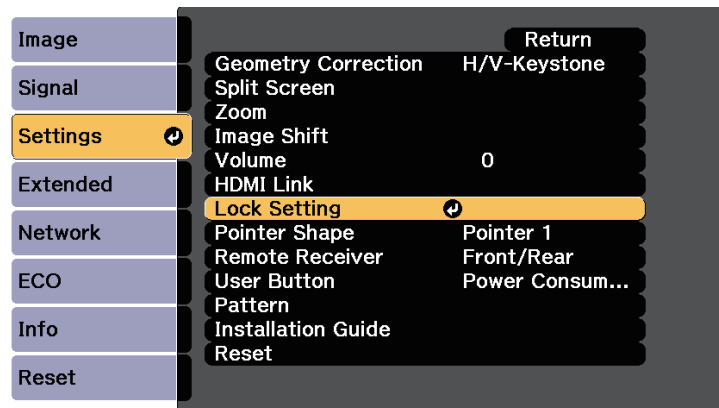

4 Select **Control Panel Lock** and press [Enter].

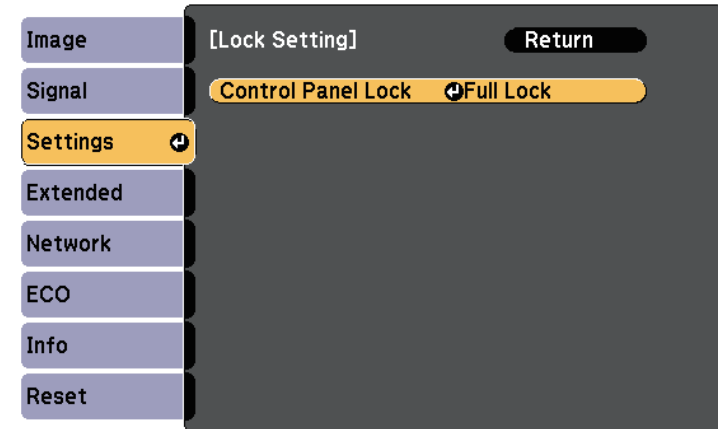

5 Select one of these lock types and press [Enter]:

- To lock all of the projector's buttons, select **Full Lock**.
 - To lock all buttons except the power button, select **Partial Lock**.
- You see a confirmation prompt.

6 Select **Yes** and press [Enter].
The **Control Panel Lock** setting takes effect.

» Related Links

- "Unlocking the Projector's Buttons" [p.170](#)

Unlocking the Projector's Buttons

If the projector's buttons have been locked, do one of the following to unlock them.

- Hold down the [Enter] button on the control panel for 7 seconds. A message is displayed and the lock is released.
- Select **Off** as the **Control Panel Lock** setting in the projector's **Settings** menu.

☛ Settings > Lock Setting > Control Panel Lock

▶ Related Links

- "Projector Feature Settings - Settings Menu" p.210

Installing a Security Cable

You can install the security cable on the projector to deter theft.

- Use the security slot on the projector to attach a Kensington Microsaver Security system.



For more details on the Microsaver Security System, see <http://www.kensington.com/>.

- Use the security cable attachment point on the projector to attach a wire cable and secure it to a room fixture or heavy furniture.

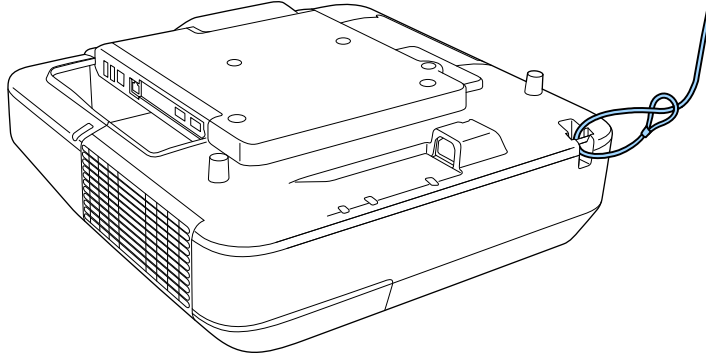

You can use a commercially available theft-prevention wire lock. See the documentation supplied with the wire lock for locking instructions.

Using the Projector on a Network

Follow the instructions in these sections to set up your projector for use on a network.

► **Related Links**

- "Wired Network Projection" [p.173](#)
- "Wireless Network Projection" [p.176](#)
- "Secure HTTP" [p.184](#)

You can send images to your projector through a wired network. To do this, connect the projector to your network, and then set up your projector and computer for network projection.

After connecting and setting up the projector as described here, install EasyMP Multi PC Projection from the Epson Projector Software CD-ROM (if available) or Web site.

EasyMP Multi PC Projection software sets up your computer for network projection. It also allows you to hold interactive meetings by projecting user's computer screens over a network. See the *EasyMP Multi PC Projection Operation Guide* for instructions.

► Related Links

- "Connecting to a Wired Network" [p.173](#)
- "Selecting Wired Network Settings" [p.173](#)

Connecting to a Wired Network

To connect the projector to a wired local area network (LAN), use a 100Base-TX or 10Base-T network cable. To ensure proper data transmission, use a Category 5 shielded cable or better.

- 1** Connect one end of the network cable to your network hub, switch, or router.

- 2** Connect the other end of the cable to the projector's LAN port.

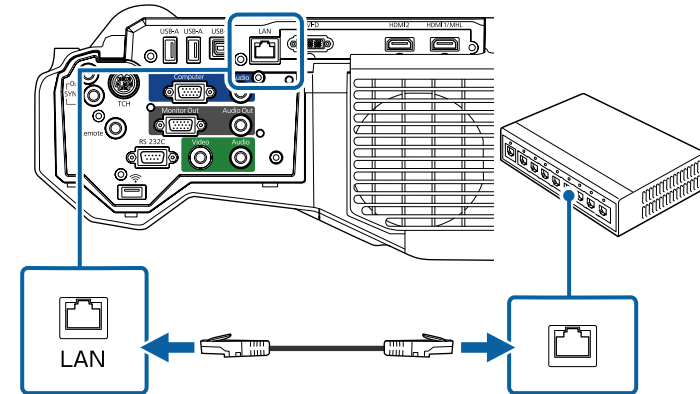

Selecting Wired Network Settings

Before you can project from computers on your network, you need to select network settings on the projector.



Make sure you already connected the projector to your wired network using the LAN port.

- 1** Press the [Menu] button on the control panel or remote control.

2 Select the **Network** menu and press [Enter].

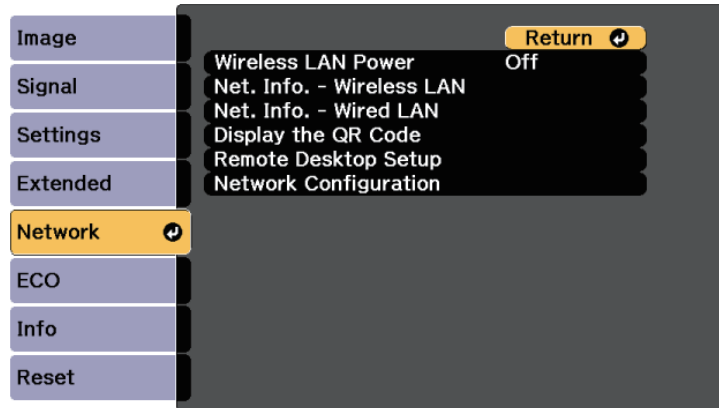

3 Select **Network Configuration** and press [Enter].

4 Select the **Basic** menu and press [Enter].

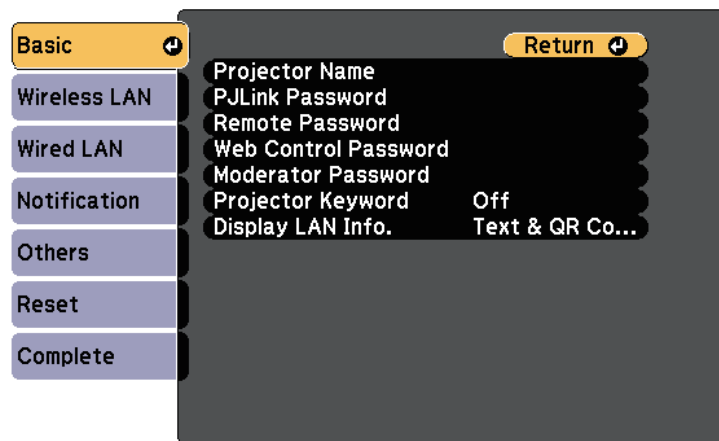

5 Select the basic options as necessary.

- **Projector Name** lets you enter a name up to 16 alphanumeric characters long to identify the projector over the network.
- **PJLink Password** lets you enter a password up to 32 alphanumeric characters long for using the PJLink protocol for projector control.
- **Remote Password** lets you enter a password up to 8 alphanumeric characters long for accessing the projector using the Web Remote. (User name is **EPSONREMOTE**; default password is **guest**.)
- **Web Control Password** lets you enter a password up to 8 alphanumeric characters long for accessing the projector over the Web. (User name is **EPSONWEB**; default password is **admin**.)
- **Moderator Password** lets you enter a four-digit number password for accessing the projector as a moderator using EasyMP Multi PC Projection or Epson iProjection. (No password is set by default.)
- **Projector Keyword** lets you turn on a security password to prevent access to the projector by anyone not in the room with it. You must enter a displayed, randomized keyword from a computer using EasyMP Multi PC Projection or Epson iProjection to access the projector and share the current screen.
- **Display LAN Info.** lets you set the display format for the projector's network information.



Use the displayed keyboard to enter the name, passwords and keyword. Press the arrow buttons on the remote control to highlight characters and press [Enter] to select them.

- 6** Select the **Wired LAN** menu and press [Enter].

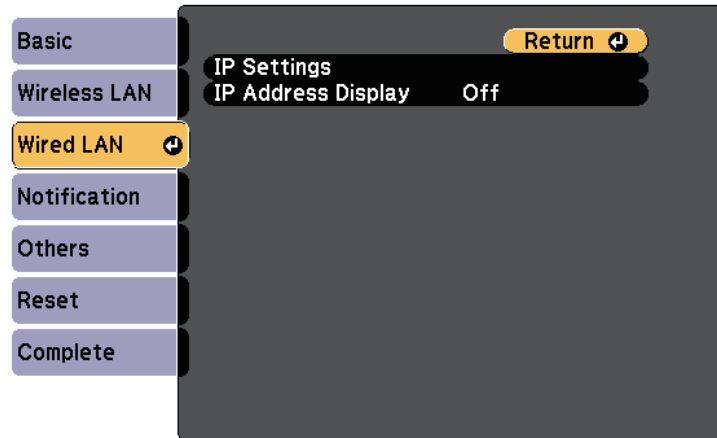

- 7** Select **IP Settings** and press [Enter].

- 8** Select your **IP Settings** as necessary.

- If your network assigns addresses automatically, set the **DHCP** setting to **On**.
- If you must set addresses manually, set the **DHCP** setting to **Off** and enter the projector's **IP Address**, **Subnet Mask**, and **Gateway Address** as necessary.



To highlight the numbers you want from the displayed keyboard, press the arrow buttons on the remote control. To select a highlighted number, press [Enter].

- 9** To prevent the IP address from being displayed on the LAN standby screen and Home screen, set the **IP Address Display** setting to **Off**.

- 10** When you finish selecting settings, select **Complete** and follow the on-screen instructions to save your settings and exit the menus.

- 11** Press the [LAN] button on the remote control.

The wired network settings complete when you see the correct IP address on the LAN standby screen.

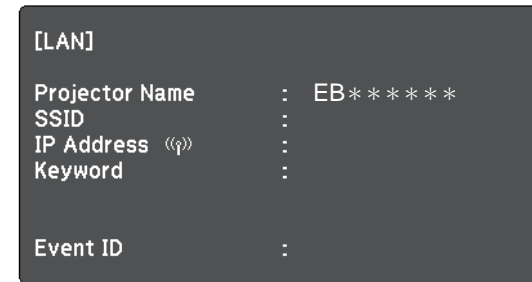

You can send images to your projector through a wireless network.

To do this, you must install the Epson 802.11b/g/n wireless LAN module, and then set up your projector and computer for wireless projection using the projector's **Network** menus.

After installing the wireless LAN module and setting up the projector, install the network software from the Epson Projector Software CD-ROM (if available) or download the software, as necessary. Use the following software and documentation to set up and control wireless projection:

- EasyMP Multi PC Projection software allows you to hold interactive meetings by projecting the computer screens of users over a network. See the *EasyMP Multi PC Projection Operation Guide* for instructions.
- Epson iProjection app allows you to project from iOS or Android devices. You can download Epson iProjection from App Store or Google play. Any fees incurred when communicating with App Store or Google play are the responsibility of the customer.

» Related Links

- "Installing the Wireless LAN Module" [p.176](#)
- "Selecting Wireless Network Settings Manually" [p.177](#)
- "Selecting Wireless Network Settings in Windows" [p.179](#)
- "Selecting Wireless Network Settings in OS X" [p.179](#)
- "Setting Up Wireless Network Security" [p.179](#)
- "Using a QR Code to Connect a Mobile Device" [p.182](#)
- "Using a USB Key to Connect a Windows Computer" [p.182](#)

Installing the Wireless LAN Module

To use the projector over a wireless network, install the Epson 802.11b/g/n wireless LAN module. Do not install any other type of wireless LAN module.

Attention

Never remove the module while its indicator is blue or flashing, or while you are projecting wirelessly. This could damage the module or lose data.

- 1 Remove both of the cable cover screws to open the cable cover.

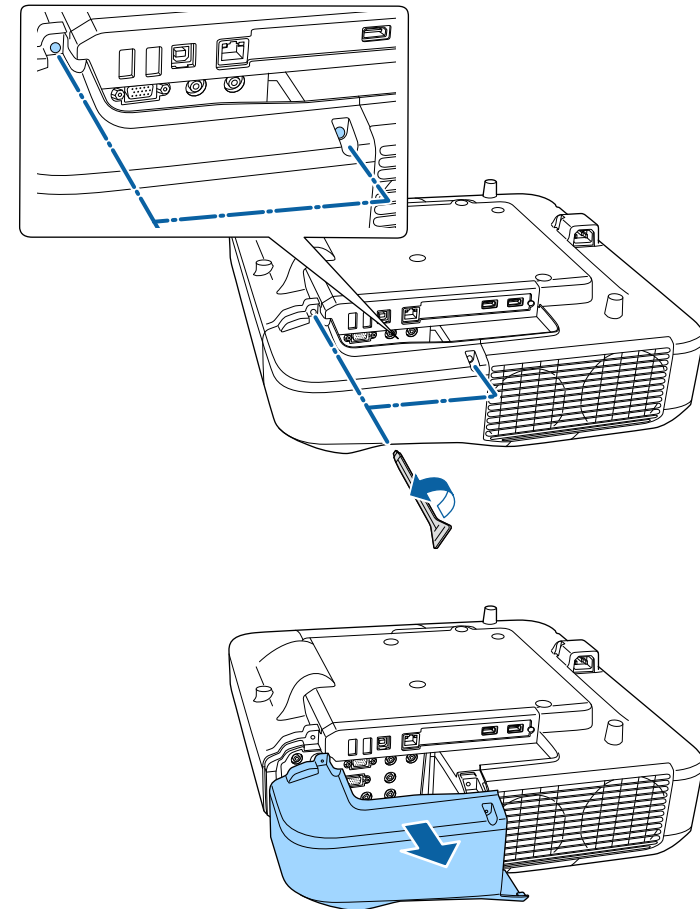

- 2 Connect the Wireless LAN module to the wireless LAN module slot.

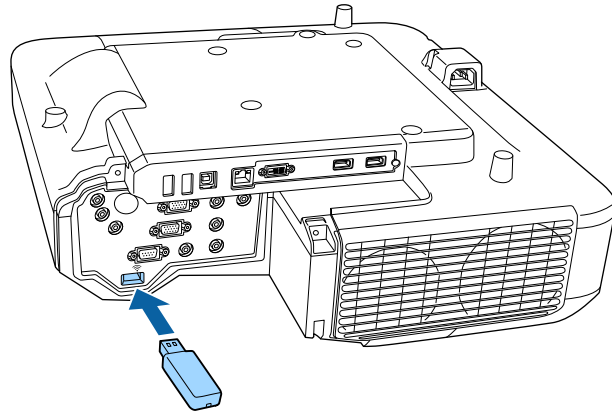

- 3 Select **On** as the **Wireless LAN Power** setting.

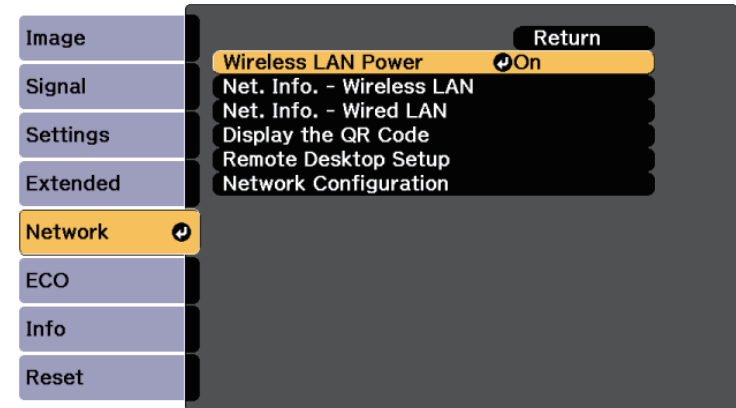

Selecting Wireless Network Settings Manually

Before you can project from your wireless network, you need to select network settings for the projector.

- 1 Press the [Menu] button on the control panel or remote control.
- 2 Select the **Network** menu and press [Enter].

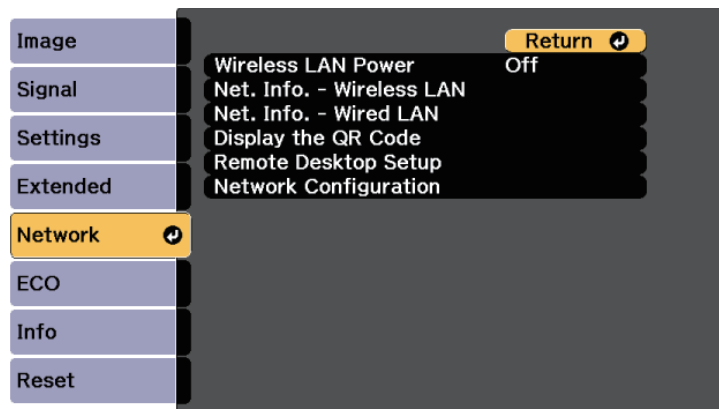

- 4 Select **Network Configuration** and press [Enter].
- 5 Select the **Basic** menu and press [Enter].

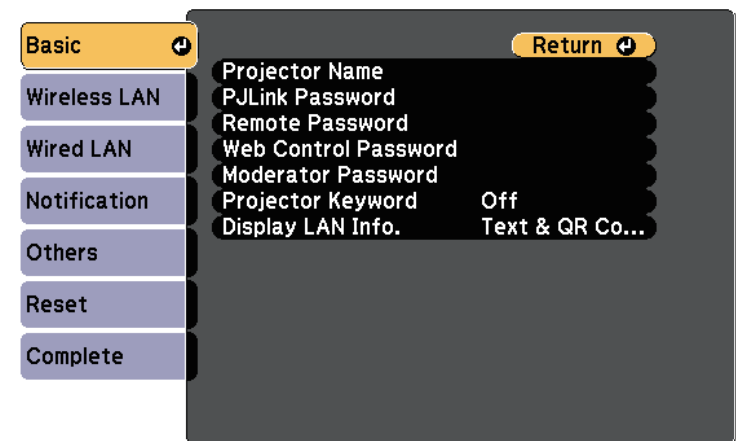

6 Select the basic options as necessary.

- **Projector Name** lets you enter a name up to 16 alphanumeric characters long to identify the projector over the network.
- **PJLink Password** lets you enter a password up to 32 alphanumeric characters long for using the PJLink protocol for projector control.
- **Remote Password** lets you enter a password up to 8 alphanumeric characters long for accessing the projector using the Web Remote. (User name is **EPSONREMOTE**; default password is **guest**.)
- **Web Control Password** lets you enter a password up to 8 alphanumeric characters long for accessing the projector over the Web. (User name is **EPSONWEB**; default password is **admin**.)
- **Moderator Password** lets you enter a four-digit number password for accessing the projector as a moderator using EasyMP Multi PC Projection or Epson iProjection. (No password is set by default.)
- **Projector Keyword** lets you turn on a security password to prevent access to the projector by anyone not in the room with it. You must enter a displayed, randomized keyword from a computer using EasyMP Multi PC Projection or Epson iProjection to access the projector and share the current screen.
- **Display LAN Info.** lets you set the display format for the projector's network information.

 Use the displayed keyboard to enter the name and password. Press the arrow buttons on the remote control to highlight characters and press [Enter] to select them.

7 Select the **Wireless LAN** menu and press [Enter].

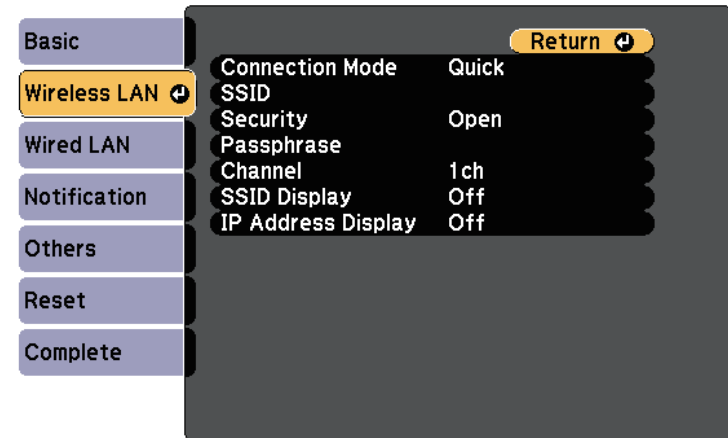

8 Select the **Connection Mode** setting.

- **Quick** lets you connect to multiple smartphones, tablets, or computers directly using wireless communication.
- **Advanced** lets you connect to smartphones, tablets, or computers over a wireless network access point.

9 If you selected the **Advanced** connection mode, select **Search Access Point** to select the access point you want to connect to.

 If you need to assign the SSID manually, select **SSID** to enter the SSID.

10 For the **Advanced** connection mode, assign the IP settings for your network as necessary.

- If your network assigns addresses automatically, select **IP Settings** to set the **DHCP** setting to **On**.
- If you must set addresses manually, select **IP Settings** to set the **DHCP** setting to **Off**, and then enter the projector's **IP Address**, **Subnet Mask**, and **Gateway Address** as necessary.

- 11** To prevent the SSID or IP address from being displayed on the LAN standby screen and Home screen, set the **SSID Display** setting or the **IP Address Display** setting to **Off**.
- 12** When you have finished selecting settings, select **Complete** and then follow the on-screen instructions to save your settings and exit the menus.
- 13** Press the [LAN] button on the remote control.
The wireless network settings are complete when you see the correct IP address on the LAN standby screen.

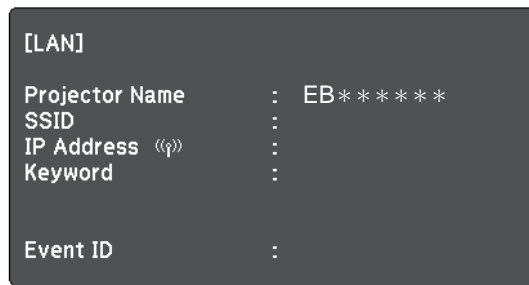

When you have finished making wireless settings for your projector, you need to select the wireless network on your computer. Then start the network software to send images to your projector through a wireless network.

Selecting Wireless Network Settings in Windows

Before connecting to the projector, select the correct wireless network on your computer.

- 1** To access your wireless utility software, double-click the network icon on the Windows taskbar.

- 2** When connecting in Advanced connection mode, select the network name (SSID) of the network the projector is connecting to.
- 3** Click **Connect**.

Selecting Wireless Network Settings in OS X

Before connecting to the projector, select the correct wireless network in OS X.

- 1** Click the AirPort icon on the menu bar at the top of the screen.
- 2** When connecting in Advanced connection mode, make sure AirPort is turned on and select the network name (SSID) of the network the projector is connecting to.

Setting Up Wireless Network Security

You can set up security for your projector to use on a wireless network. Set up one of the following security options to match the settings used on your network:

- WPA2-PSK security
- WPA2-EAP security *
- WPA/WPA2-PSK security *
- WPA/WPA2-EAP security *

* Only available for the Advanced connection mode.



Contact your network administrator for guidance on entering the correct information.

- 1** If you want to set up the WPA2-EAP or WPA/WPA2-EAP security, make sure your digital certificate file is compatible with projector registration and placed directly on the USB storage device.
- 2** Press the [Menu] button on the control panel or remote control.
- 3** Select the **Network** menu and press [Enter].
- 4** Select **Network Configuration** and press [Enter].
- 5** Select the **Wireless LAN** menu and press [Enter].

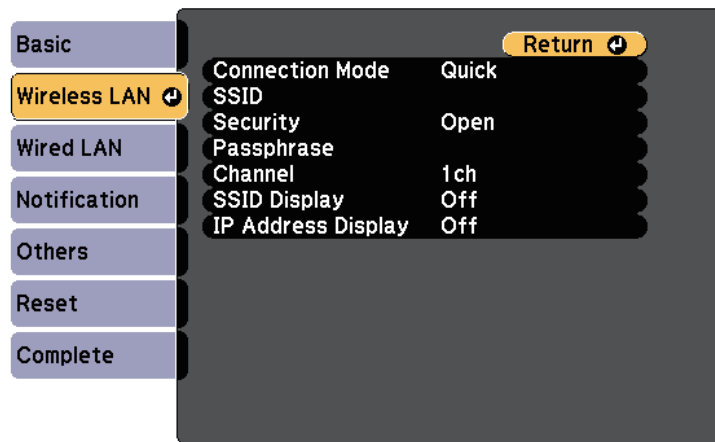

- 6** Select the **Security** setting and press [Enter].

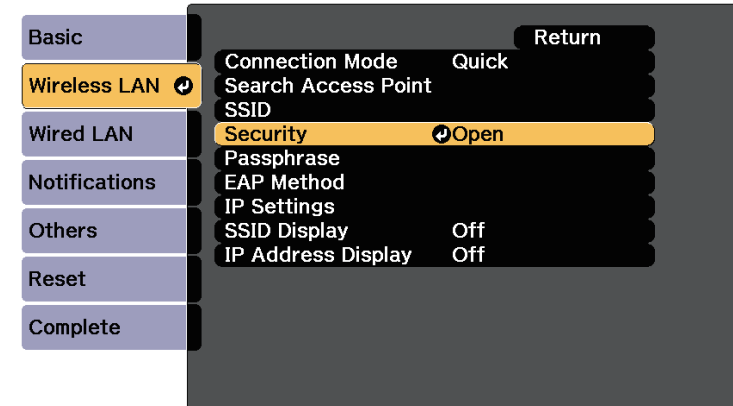

- 7** Select the security settings to match your network settings.
- 8** Do one of the following according to the security you selected.
 - **WPA2-PSK, WPA/WPA2-PSK:** Select **Complete** and follow the on-screen instructions to save your settings and exit the menus.
 - **WPA2-EAP, WPA/WPA2-EAP:** Select **EAP Method** and press [Enter].
- 9** Select the protocol for authentication as the **EAP Type** setting.
- 10** To import your certificate, select the certificate type and press [Enter].
 - **Client Certificate** for the **PEAP-TLS** or **EAP-TLS** type
 - **CA certificate** for the **PEAP, PEAP-TLS, EAP-TLS, or EAP-FAST** type



You can also register the digital certificates from your Web browser. However, be sure to register just once or the certificate may not install correctly.

- 11** Select **Register** and press [Enter].
- 12** Follow the on-screen instructions to connect a USB storage device to the projector's USB-A port.
- 13** Press [Enter] to display the certificate list.
- 14** Select the certificate to import using the displayed list.
A message is displayed prompting you to enter the password for the certificate.
- 15** Enter a password and press [Enter].
The certificate is imported and a completion message appears.
- 16** Select your EAP settings as necessary.
 - **User name** lets you enter a user name using up to 63 alphanumeric characters. To enter more than 32 characters, use your Web browser. When importing a client certificate, the name the certificate was issued to is automatically set.
 - **Password** lets you enter a password using up to 63 alphanumeric characters for authentication when using the **PEAP**, **EAP-FAST**, or **LEAP** type. To enter more than 32 characters, use your Web browser.
 - **Verify Server Certificate** lets you select whether or not to verify the server certificate when a CA certificate has been set.

- **RADIUS Server Name** lets you enter the server name to be verified.

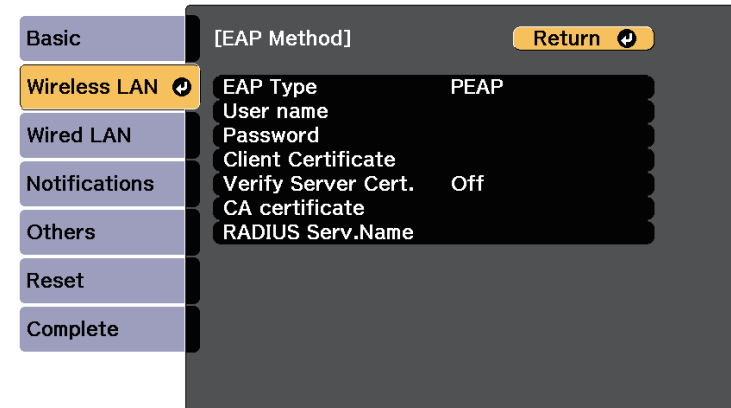

- 17** When you have finished making settings, select **Complete** and follow the on-screen instructions to save your settings and exit the menus.

» Related Links

- "Supported Client and CA Certificates" [p.181](#)
- "Network Menu - Wireless LAN Menu" [p.227](#)

Supported Client and CA Certificates

You can register these types of digital certificates.

Client Certificate (PEAP-TLS/EAP-TLS)

Specification	Description
Format	PKCS#12
Extension	PFX, P12
Encryption	RSA
Hashes	MD5/SHA-1/SHA-256/SHA-384/SHA-512
Key length	512/1024/2048/4096 bit

Specification	Description
Password *	Up to 32 alphanumeric characters; required

CA Certificate (PEAP/PEAP-TLS/EAP-TLS/EAP-FAST)

Specification	Description
Format	X509v3
Extension	DER/CER/PEM
Encryption	RSA
Hashes	MD5/SHA-1/SHA-256/SHA-384/SHA-512
Key length	512/1024/2048/4096 bit
Encoding	BASE64/Binary

* You can set a password using up to 63 alphanumeric characters. However, you need to use your Web browser to enter more than 32 characters.

Using a QR Code to Connect a Mobile Device

After selecting the wireless network settings for your projector, you can display a QR code on the screen and use it to connect a mobile device using the Epson iProjection app.



- Make sure you have installed the latest version of Epson iProjection on your device (V1.3.0 or later supports this feature).
- You can download Epson iProjection for free from App Store or Google play. Any fees incurred when communicating with App Store or Google play are the responsibility of the customer.
- When using Epson iProjection in Quick connection mode, we recommend making security settings.

- 1 Press the [LAN] button on the remote control.
The QR code is displayed on the projected surface.



- If you do not see the QR code, set the **Display LAN Info.** setting to **Text & QR Code** in the projector's **Network** menu.
Network > Network Configuration > Basic > Display LAN Info.
- To hide the QR code, press the [Esc] button.
- When the QR code is hidden, press the [Enter] button to display the code.
- You can also display the QR code by selecting the icon on the Home screen.

- 2 Start Epson iProjection on your mobile device.
- 3 Read the projected QR code using Epson iProjection to connect it to the projector.



To correctly read the QR code, make sure you face the screen squarely and closely enough so that the projected code fits into the guide of the mobile device's QR code reader. If you are too far from the screen, the code may not be read.

When a connection is established, select **Contents** menu from , and then select the file you want to project.

Using a USB Key to Connect a Windows Computer

You can set up your USB flash drive as a USB key to quickly connect the projector to a wireless LAN supported Windows computer. After creating the USB key, you can quickly project images from the network projector.

- 1 Set up the USB key using EasyMP Multi PC Projection.



See the *EasyMP Multi PC Projection Operation Guide* for instructions.

2 Make sure the wireless LAN module is installed into your projector.

3 Turn on the projector.

4 Press the [LAN] button on the remote control.

The LAN standby screen is displayed. Verify that an SSID and IP address are displayed.

5 Connect the USB key to the projector's USB-A port.

You see a projected message that the network information update is complete.

6 Remove the USB key.

7 Connect the USB key to a USB port on your computer.



In Windows Vista, if the AutoPlay window is displayed, select **MPPLaunch.exe**, then select **Allow**.

8 Follow the on-screen instructions to install the necessary application.



- If the Windows Firewall message is displayed, click **Yes** to disable the firewall.
- You need administrator authority to install the software.
- If it is not installed automatically, double-click **MPPLaunch.exe** in the USB key.

After a few minutes, your computer image is displayed by the projector.

9 When you have finished projecting wirelessly, select the **Safely Remove Hardware** option in the Windows taskbar, and then remove the USB key from your computer.



You may need to restart your computer to reactivate your wireless LAN connection.

You can use the HTTPS protocol to increase security between the projector and a Web browser communicating with it. To do this, you create a server certificate, install it on the projector, and turn on the **Secure HTTP** setting in the projector menus to verify the reliability of the Web browser.

☛ **Network > Network Configuration > Others > Secure HTTP**

Even if you do not install a server certificate, the projector automatically creates a self-signed certificate and allows communication. However, because the self-signed certificate cannot verify reliability from a Web browser, you see a warning about the server's reliability when you access the projector from a Web browser. This warning does not prevent communication.

» **Related Links**

- "Importing a Web Server Certificate Using the Menus" [p.184](#)

Importing a Web Server Certificate Using the Menus

You can create your Web server certificate, and import it using the projector menus and a USB flash drive.



You can also register the digital certificates from your Web browser. However, be sure to register just once or the certificate may not install correctly.

- 1** Make sure your digital certificate file is compatible with projector registration and directly placed on the USB storage device.
- 2** Press the [Menu] button on the control panel or remote control.
- 3** Select the **Network** menu and press [Enter].
- 4** Select **Network Configuration** and press [Enter].

- 5** Select the **Others** menu and press [Enter].

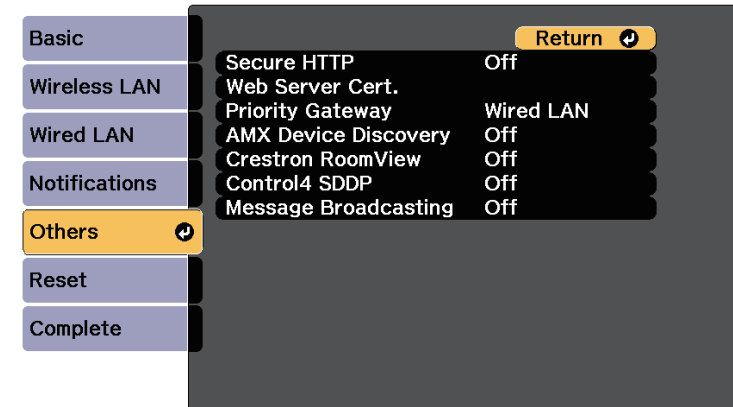

- 6** Select **On** as the **Secure HTTP** setting.
- 7** Select **Web Server Cert.** and press [Enter].
- 8** Select **Register** and press [Enter].
- 9** Follow the on-screen instructions to connect a USB storage device to the projector's USB-A port.
- 10** Press [Enter] to display the certificate list.
- 11** Select the certificate to import using the displayed list.
A message is displayed prompting you to enter the password for the certificate.
- 12** Enter a password and press [Enter].
The certificate is imported and a completion message appears.

» **Related Links**

- "Supported Web Server Certificates" [p.185](#)

Supported Web Server Certificates

You can register these types of digital certificates.

Web Server Certificate (Secure HTTP)

Specification	Description
Format	PKCS#12
Extension	PFX, P12
Encryption	RSA
Hashes	MD5/SHA-1/SHA-256/SHA-384/SHA-512
Key length	512/1024/2048/4096 bit
Common name	Network host name
Organization	Optional
Password *	Up to 32 alphanumeric characters; required

* You can set a password using up to 63 alphanumeric characters. However, you need to use your Web browser to enter more than 32 characters.

Monitoring and Controlling the Projector

Follow the instructions in these sections to monitor and control the projector over a network.

► Related Links

- "EasyMP Monitor" [p.187](#)
- "Controlling a Networked Projector Using a Web Browser" [p.188](#)
- "Setting Up Projector Network E-Mail Alerts" [p.191](#)
- "Setting Up Monitoring Using SNMP" [p.192](#)
- "Using ESC/VP21 Commands" [p.193](#)
- "PJLink Support" [p.195](#)
- "Crestron RoomView Support" [p.196](#)
- "Setting Projector Event Schedules" [p.200](#)

EasyMP Monitor software (Windows only) lets you monitor and control your projector through the network. See the *EasyMP Monitor Operation Guide* for instructions.

You can download EasyMP Monitor from the following Web site.

<http://www.epson.com/>

Once you have connected your projector to your network, you can select projector settings and control projection using a compatible Web browser. This lets you access the projector remotely.



- Make sure the computer and projector are connected to the network. When projecting images using a wireless LAN, connect in **Advanced** connection mode.
- The Web setup and control features support Internet Explorer 9.0 or later (Windows), and Safari (OS X) on networks that do not use a proxy server for connection. You cannot select all of the projector menu settings or control all projector functions using a Web browser.
- If you set **Standby Mode to Communication On** in the projector's **ECO** menu, you can use a Web browser to select settings and control projection even if the projector is in standby mode (when the power is off).

- 1** Make sure the projector is turned on.
- 2** Make sure your computer or device is connected to the same network as the projector.
- 3** Start your Web browser on the computer or device.
- 4** Go to the Epson Web Control screen by entering the projector's IP address into the browser's address box.
- 5** Select the  icon to access the Web Control screen.



- You may need to log in before you see the Web Control screen. If a login screen is displayed, enter your user name and password. (The user name is **EPSONWEB** and the default password is **admin**.)
- You can change the password in **Web Control Password** in the projector's **Network** menu.
☛ **Network > Network Configuration > Basic > Web Control Password**

- 6** To select projector menu settings, select the name of the menu and follow the on-screen instructions to select settings.



- You cannot select the following settings using a Web browser.
 - Image Shift
 - HDMI Link
 - Pointer Shape
 - User Button
 - Test Pattern
 - Easy Interactive Function
 - User's Logo
 - USB Type B
 - Language
 - Event ID
 - Reset Lamp Hours
 - Printer Settings
- You can select the following settings only using a Web browser.
 - Monitor Password (up to 16 alphanumeric characters)
 - HTTP port (port number used for Web Control except for 80 [default], 843, 3620, 3621, 3625, 3629, 4352, 4649, 5357, 10000, 10001, 41794)

- 7** To control projection remotely, select the  icon.



- If you see a log in window, enter your user name and password. (The user name is **EPSONREMOTE** and the default password is **guest**.)
- You can change the password in **Remote Password** in the projector's **Network** menu.
☛ **Network > Network Configuration > Basic > Remote Password**

- 8** Select the icon corresponding to the projector function you want to control.

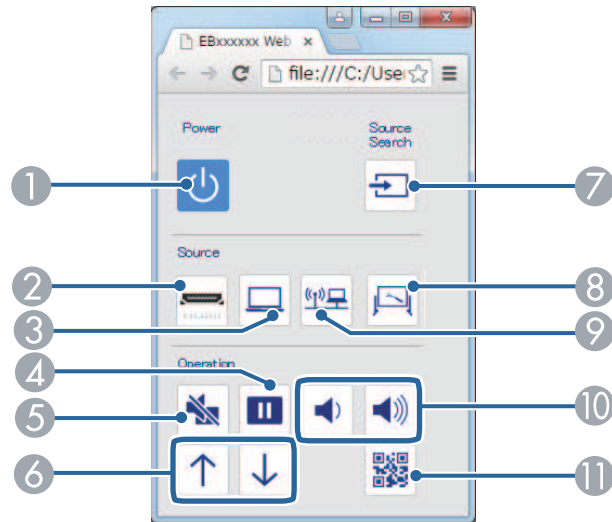

- 1 Power button control
- 2 Selects HDMI port source
- 3 Selects Computer port source
- 4 Freeze button control
- 5 A/V Mute button control
- 6 Page up and down button controls
- 7 Searches for sources
- 8 Selects the Whiteboard source
- 9 Selects the network source
- 10 Volume button controls
- 11 Displays the QR code

- "Network Menu - Basic Menu" [p.226](#)
- "Projector Setup Settings - ECO Menu" [p.233](#)

Registering Digital Certificates from a Web Browser

You can register the digital certificates on the projector to provide security for your presentation files.



You can also register the digital certificates in the projector's **Network** menu. However, be sure to register just once or the certificate may not install correctly.

☛ **Network > Network Configuration > Wireless LAN > EAP Method > Client Certificate**

☛ **Network > Network Configuration > Wireless LAN > EAP Method > CA certificate**

☛ **Network > Network Configuration > Others > Web Server Certificate**

- 1** Make sure your digital certificate file is compatible with projector registration.
- 2** Make sure the projector is turned on.
- 3** Start your Web browser on a computer or device connected to the network.
- 4** Go to the Epson Web Control screen by entering the projector's IP address into the browser's address box.
- 5** Select the  icon to access the Web Control screen.

» Related Links

- "Registering Digital Certificates from a Web Browser" [p.189](#)



- You may need to log in before you see the Web Control screen. If a login screen is displayed, enter your user name and password. (The user name is **EPSONWEB** and the default password is **admin**.)
- You can change the password in **Web Control Password** from the projector's **Network** menu.
 - ☛ **Network > Network Configuration > Basic > Web Control Password**
- You need to select the **Config** icon to access the Web Control screen using your mobile device.

- 9 When you finish registering the certificate, click **Apply** to finalize your changes and complete the registration.

- 6 Under **Network**, select **Manage Certificates**.

You see a screen like this:

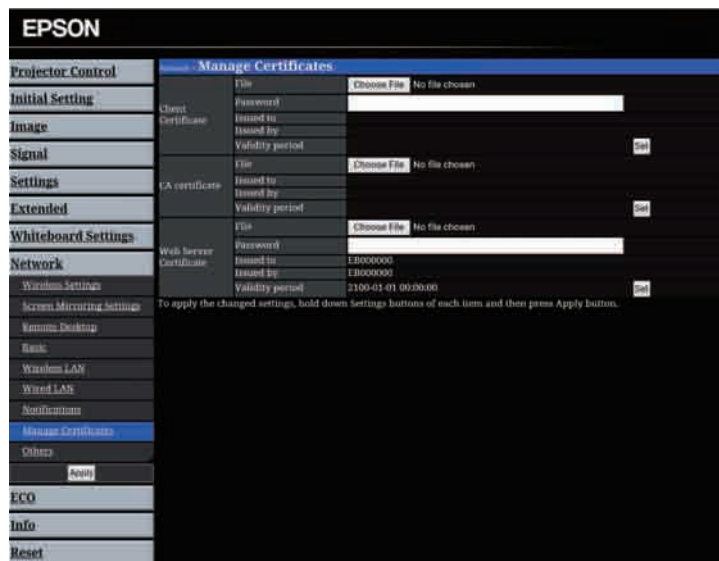

- 7 Click the **Browse** button, select the certificate file, and click **Open**.

- 8 Enter a password in the **Password** box.

You can set up the projector to send you an e-mail alert over the network if there is a problem with the projector.

If you set the **Standby Mode** setting to **Communication On** in the projector's **ECO** menu, you can receive the e-mail alerts even if the projector is in standby mode (when the power is off).

- 1** Press the [Menu] button on the control panel or remote control.
- 2** Select the **Network** menu and press [Enter].
- 3** Select **Network Configuration** and press [Enter].
- 4** Select the **Notifications** menu and press [Enter].

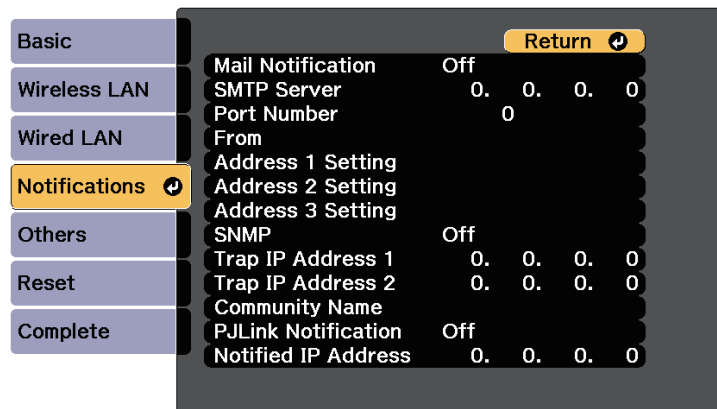

- 5** Set the **Mail Notification** setting to **On**.
- 6** Enter the IP address for the **SMTP Server** option.

Do not use these addresses: 127.x.x.x, 192.0.2.x, or 224.0.0.0 through 255.255.255.255 (where x is a number from 0 to 255).

- 7** Select a number for the SMTP server **Port Number**, from 1 to 65535 (default is 25).
- 8** Enter the e-mail address to be indicated as the sender in **From**.
- 9** Choose an address field, enter the e-mail address, and select the alerts you want to receive. Repeat for up to three addresses.

Your e-mail address can be up to 32 alphanumeric characters long.

- 10** When you finish selecting settings, select **Complete** and follow the on-screen instructions to save your settings and exit the menus.

If a critical problem causes a projector to shut down, you may not receive an e-mail alert.

► Related Links

- "Network Projector E-mail Alert Messages" [p.191](#)
- "Projector Setup Settings - ECO Menu" [p.233](#)

Network Projector E-mail Alert Messages

When a problem occurs with a projector on the network, and you selected to receive e-mail alerts, you receive an e-mail containing the following information:

- The email address set in **From** as the mail sender
- **Epson Projector** in the subject line
- The name of the projector experiencing a problem
- The IP address of the affected projector
- Detailed information about the problem

Network administrators can install SNMP (Simple Network Management Protocol) software on network computers so they can monitor projectors. If your network uses this software, you can set up the projector for SNMP monitoring.

- 1 Press the [Menu] button on the control panel or remote control.
- 2 Select the **Network** menu and press [Enter].
- 3 Select **Network Configuration** and press [Enter].
- 4 Select the **Notifications** menu and press [Enter].

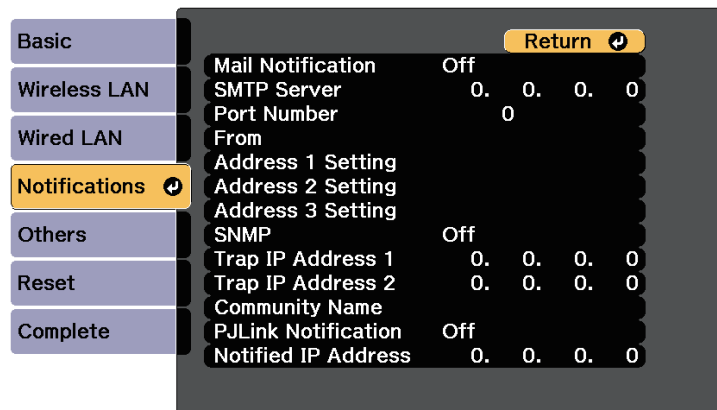

- 5 Set the SNMP setting to **On**.
- 6 Enter up to two IP addresses to receive SNMP notifications, using 0 to 255 for each address field.



Do not use these addresses: 127.x.x.x or 224.0.0.0 through 255.255.255.255 (where x is a number from 0 to 255). This projector supports SNMP agent version 1 (SNMPv1).

- 7 Enter the SNMP **Community Name** up to 32 alphanumeric characters long.
- 8 When you have finished selecting settings, select **Complete** and follow the on-screen instructions to save your settings and exit the menus.

You can control the projector from an external device using ESC/VP21.

► **Related Links**

- "ESC/VP21 Command List" [p.193](#)
- "Cable Layouts" [p.193](#)

ESC/VP21 Command List

When the power ON command is transmitted to the projector, the power turns on and it enters warm-up mode. When the projector's power has turned on, a colon ":" (3Ah) is returned.

When a command is input, the projector executes the command and returns a ":", and then accepts the next command.

If the command being processed terminates abnormally, an error message is output and a ":" is returned.

The following commands are available.

Item		Command	
Power On/Off	On	PWR ON	
	Off	PWR OFF	
Signal selection	Computer	Auto	SOURCE 1F
		RGB	SOURCE 11
		Component	SOURCE 14
	HDMI1/MHL		SOURCE 30
	HDMI2		SOURCE A0
	Video		SOURCE 41
	USB Display		SOURCE 51
	USB1		SOURCE 52
	LAN		SOURCE 53
	USB2		SOURCE 54
	Whiteboard		SOURCE 55

Item	Command	
A/V Mute On/Off	On	MUTE ON
	Off	MUTE OFF

Add a Carriage Return (CR) code (0Dh) to the end of each command and transmit.

Contact Epson for more details.

Cable Layouts

Serial connection

- Connector shape: D-Sub 9-pin (male)
- Projector input port name: RS-232C
- Cable type: Crossover (null modem) cable

In the following illustration, the projector side is shown on the left, and the computer side on the right:

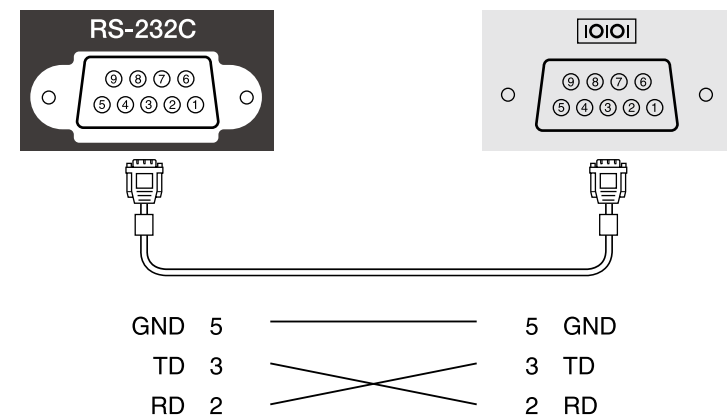

Signal name	Function
GND	Signal wire ground
TD	Transmit data
RD	Receive data

Communications protocol

- Default baud rate setting: 9600 bps
- Data length: 8 bit
- Parity: None
- Stop-bit: 1 bit
- Flow control: None

PJLink was established by the JBMIA (Japan Business Machine and Information System Industries Association) as a standard protocol for controlling network-compatible projector's as part of their efforts to standardize projector control protocols.

The projector complies with the PJLink Class2 standard established by the JBMIA.

The port number used for the PJLink search function is 4352 (UDP).

You need to make network settings before you can use PJLink.

It complies with all commands except for the following commands defined by PJLink Class2, and agreement was confirmed by the PJLink standard adaptability verification.

<http://pjlink.jbmia.or.jp/english/>

- Non-compatible commands

Function		PJLink command
Mute settings	Image muting set	AVMT 11
	Audio muting set	AVMT 21

- Input ports and corresponding input source number

Input port name	Input source number
Computer	11
Video	21
HDMI1/MHL	32
HDMI2	33
USB1	41
USB2	42
LAN	52
USB Display	53
Whiteboard	55

- Manufacturer name displayed for "Manufacture name information query"
EPSON
- Model name displayed for "Product name information query"
 - EPSON 1450Ui/UT
 - EPSON 1440Ui/UT

If you are using the Crestron RoomView network monitoring and control system, you can set up your projector for use on the system. Crestron RoomView lets you control and monitor your projector using a Web browser.



- You cannot use the Epson Web Control feature or the Message Broadcasting plug-in for EasyMP Monitor when you use Crestron RoomView.
- If you set the **Standby Mode** setting to **Communication On** in the projector's **ECO** menu, you can control the projector even if the projector is in standby mode (when the power is off).

For additional information on Crestron RoomView, visit the Crestron Web site.

<http://www.crestron.com>

To monitor devices in the system, you can use Crestron RoomView Express or Crestron RoomView Server Edition provided by Creston. You can communicate with the help desk and send emergency messages. See the following Web site for details.

<http://www.crestron.com/getroomview>

This manual describes how to perform operations on your computer using a Web browser.

» **Related Links**

- "Setting Up Crestron RoomView Support" [p.196](#)
- "Controlling a Networked Projector Using Crestron RoomView" [p.196](#)

Setting Up Crestron RoomView Support

To set up your projector for monitoring and control using a Crestron RoomView system, make sure your computer and projector are connected to the network. If you are connecting wirelessly, set up the projector using the Advanced network connection mode.

- 1** Press the [Menu] button on the control panel or remote control.
- 2** Select the **Network** menu and press [Enter].

- 3** Select **Network Configuration** and press [Enter].

- 4** Select the **Others** menu and press [Enter].

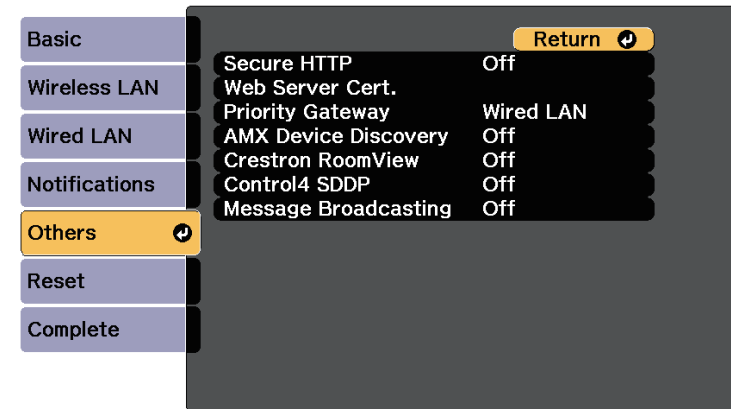

- 5** Set the **Crestron RoomView** setting to **On** to allow the projector to be detected.

- 6** When you have finished selecting settings, select **Complete** and follow the on-screen instructions to save your settings and exit the menus.

- 7** Turn off the projector, and then turn it on again to enable the setting.

Controlling a Networked Projector Using Crestron RoomView

Once you have set up your projector to use Crestron RoomView, you can control and monitor projection using a compatible Web browser.

- 1** Start your Web browser on a computer connected to the network.
- 2** Type the projector's IP address into the browser's address box and press the computer's **Enter** key.

You see this screen:



3 Select the input source that you want to control in the **Sources List** box. You can scroll through available sources using the up and down arrows in the box.

4 To control projection remotely, click the on-screen buttons that correspond to the projector's remote control buttons. You can scroll through button options at the bottom of the screen.

 These on-screen buttons do not directly correspond to the projector's remote control buttons:

- OK acts as the [Enter] button
- Menu displays the projector's menu

5 To view information about the projector, click the **Info** tab.

6 To change the projector, Crestron, and password settings, click the **Tools** tab, select settings on the displayed screen, and then click **Send**.

7 When you finish selecting settings, click **Exit** to exit the program.

» **Related Links**

- "Crestron RoomView Operation Window" p.197
- "Crestron RoomView Tools Window" p.198

Crestron RoomView Operation Window

Settings on the operation window let you control the projector and adjust the projection image.



1	Power	Turns the projector on or off.
	Vol-/Vol+	Adjusts the volume.
	A/V Mute	Turns the video and audio on or off.
2	Switches to the image from the selected input source. To display input sources that are not shown in Sources List , click (a) or (b) to scroll up or down. The current video signal input source is displayed in blue. You can change the source name if necessary.	

3	Freeze	Images are paused or released.
	Contrast	Adjusts the difference between light and shade in the images.
	Brightness	Adjusts the image brightness.
	Color	Adjusts the color saturation for the images.
	Sharpness	Adjusts the image sharpness.
	Zoom	Enlarges or reduces the image without changing the projection size. Click the arrow buttons to change the position of an enlarged image.
4	Arrow buttons	Performs the same operations as the arrow buttons on the remote control.
	OK	Performs the same operation as [Enter] on the remote control.
	Menu	Displays and closes the projector's menu.
	Auto	Optimizes Tracking , Sync. , and Position in the projector's Signal menu while projecting an analog RGB signal from Computer port.
	Search	Changes to the next input source that is sending an image.
	Esc	Performs the same operation as the [Esc] button on the remote control.
5	Contact IT Help	Displays the Help Desk window. Used to send messages to, and receive messages from, the administrator using Crestron RoomView Express.
	Info	Displays information on the projector that is currently connected.
	Tools	Changes settings in the projector that is currently connected.

Crestron RoomView Tools Window

Settings on the Tools window let you customize various projector setup features.

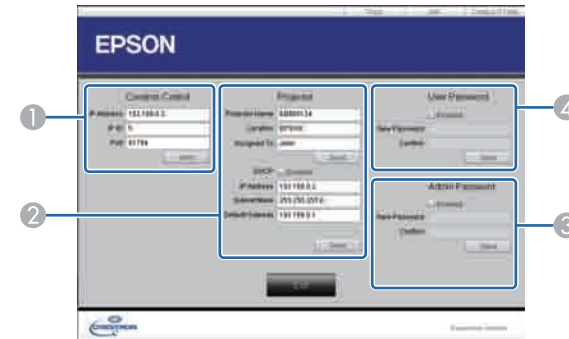

1	Make settings for Crestron central controllers.	
2	Projector Name	Enter a name to differentiate the projector that is currently connected from other projectors on the network. (up to 16 alphanumeric characters)
	Location	Enter an installation location name for the projector that is currently connected on the network. (up to 32 alphanumeric characters and symbols)
	Assigned To	Enter a user name for the projector. (up to 32 alphanumeric characters and symbols)
	DHCP	Select to use DHCP. You cannot enter an IP address if DHCP is enabled.
	IP Address	Enter the IP address to assign to the currently connected projector.
	Subnet Mask	Enter a subnet mask for the currently connected projector.
	Default Gateway	Enter the gateway address for the currently connected projector.
	Send	Click to confirm the changes made to the Projector.

3	Enabled (Admin Password)	Select to require a password to open the Tools window.
	New Password	Enter the new password when changing the password to open the Tools window. (up to 26 alphanumeric characters)
	Confirm	Enter the same password as you entered in New Password . If the passwords are not the same, an error is displayed.
	Send	Click to confirm the changes made to the Admin Password .
4	Enabled (User Password)	Select to require a password to open the operation window on the computer.
	New Password	Enter the new password when changing the password to open the operation window. (up to 26 alphanumeric characters)
	Confirm	Enter the same password as you entered in New Password . If the passwords are not the same, an error is displayed.
	Send	Click to confirm the changes made to the User Password .

You can schedule up to 30 events to occur automatically on your projector, such as turning the projector on or off or switching the input source. The projector performs the selected events on the specified date and time in the schedule you set up.

Warning

Do not place flammable objects in front of the lens. If you schedule the projector to turn on automatically, flammable objects in front of the lens could catch on a fire.



If you set a **Schedule Protection** password, turn off your **Schedule Protection** password first.

- 1** Set the date and time in the **Date & Time** menu.
➤ **Extended > Operation > Date & Time**
- 2** Press the [Menu] button on the control panel or remote control.
- 3** Select the **Extended** menu and press [Enter].
- 4** Select **Schedule Settings** and press [Enter].

- 5** Select **Add New** and press [Enter].

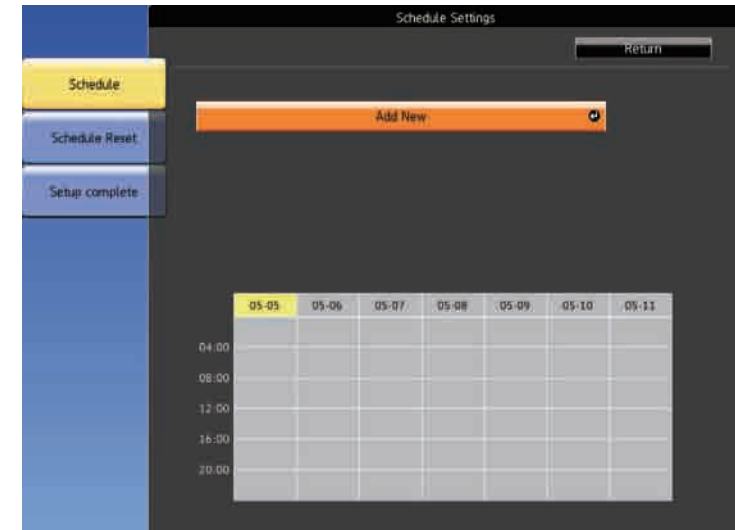

- 6** Select the event details you want to perform.

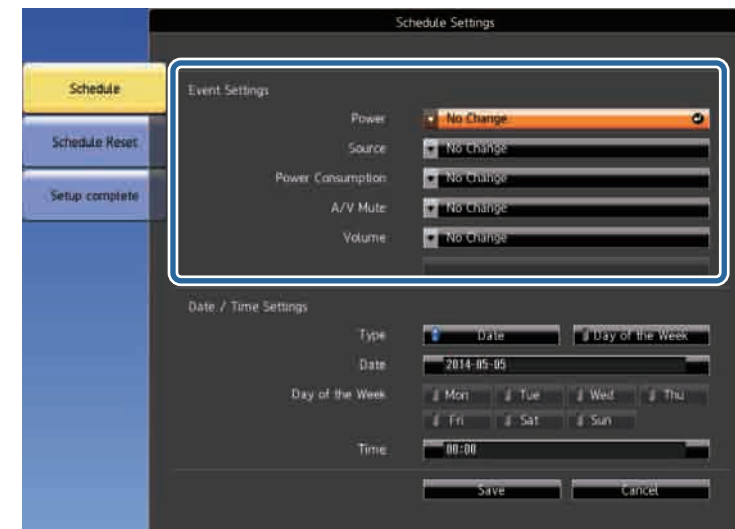

7 Select the date and time at which you want the event to occur.



8 Select **Save** and press [Enter].

The scheduled events are displayed on the screen with icons indicating the event status.



- ① : valid schedule
- : regular schedule
- : invalid schedule
- ② The date currently selected (highlighted in yellow)
- ③ : one time schedule
- : regular schedule
- : standby schedule (turns communication on or off during standby)
- : invalid schedule

9 To edit a scheduled event, select the schedule and press [Esc].

10 Select an option from the menu displayed.

- **On** or **Off** lets you enable or disable the selected event.

- **Edit** lets you change the event details or date and time.
- **Clear** lets you remove the scheduled event from a list.

11 Select **Setup complete**, then select **Yes**.

To delete all scheduled events, select **Schedule Reset**.

Adjusting the Menu Settings

Follow the instructions in these sections to access the projector menu system and change projector settings.

► Related Links

- "Using the Projector's Menus" [p.204](#)
- "Using the On-screen Keyboard" [p.205](#)
- "Image Quality Settings - Image Menu" [p.206](#)
- "Input Signal Settings - Signal Menu" [p.208](#)
- "Projector Feature Settings - Settings Menu" [p.210](#)
- "Projector Setup Settings - Extended Menu" [p.213](#)
- "Projector Network Settings - Network Menu" [p.225](#)
- "Projector Setup Settings - ECO Menu" [p.233](#)
- "Projector Information Display - Info Menu" [p.235](#)
- "Projector Reset Options - Reset Menu" [p.238](#)
- "Copying Menu Settings Between Projectors (Batch Setup)" [p.239](#)

You can use the projector's menus to adjust the settings that control how your projector works. The projector displays the menus on the screen.

- 1 Press the [Menu] button on the control panel or remote control.

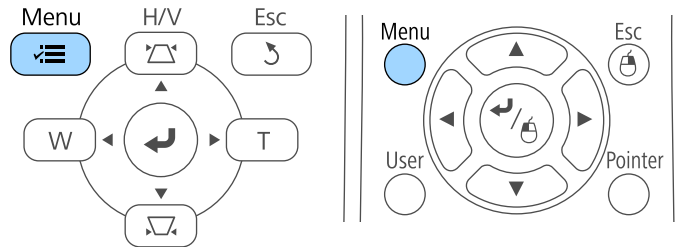

You see the menu screen displaying the **Image** menu settings.

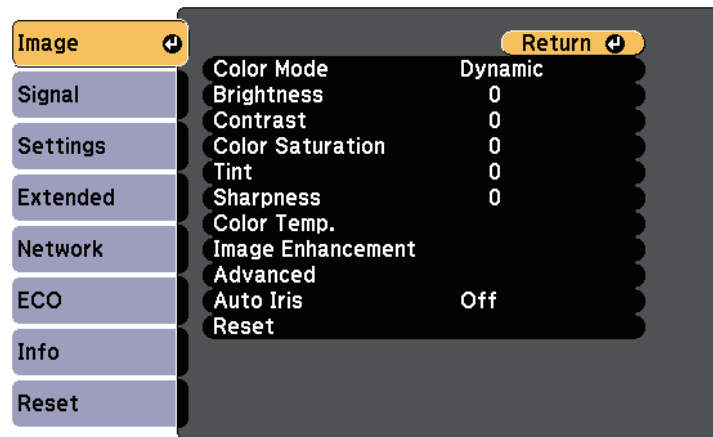

- 2 Press the up or down arrow buttons to move through the menus listed on the left. The settings for each menu are displayed on the right.





The available settings depend on the current input source.

- 3 To change settings in the displayed menu, press [Enter].
- 4 Press the up or down arrow button to move through the settings.
- 5 Change the settings using the buttons listed on the bottom of the menu screens.
- 6 To return all the menu settings to their default values, select **Reset**.
- 7 When you finish changing settings on a menu, press [Esc].
- 8 Press [Menu] or [Esc] to exit the menus.

The on-screen keyboard is displayed when you need to enter numbers and characters.

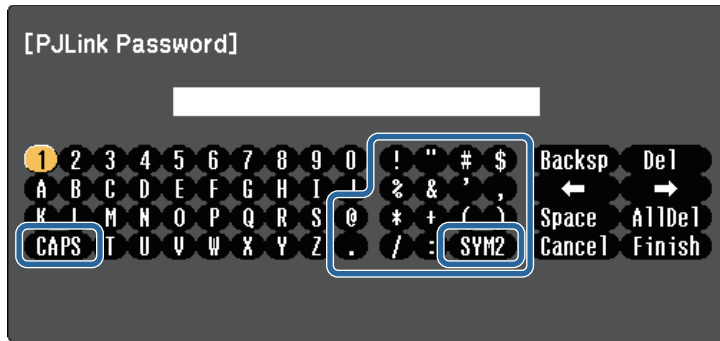
- 1 Use the arrow buttons on the control panel or remote control to highlight the number or character you want to enter and press the [Enter] button.



 Each time you select the **CAPS** key, the characters change between upper case and lower case. Each time you select the **SYM1/2** key, the symbols enclosed by the frame change.

- 2 After entering the text, select **Finish** on the keyboard to confirm your entries. Select **Cancel** to cancel entering text.

 You can select projector settings and control projection over a network using a Web browser from your computer. Some symbols cannot be entered using the on-screen keyboard. Use your Web browser to enter the text.

Available Text Using the On-screen Keyboard

You can enter the following text when using the on-screen keyboard.

Text type	Details
Numbers	0123456789
Alphabet	ABCDEFGHIJKLMNOPQRSTUVWXYZ abcdefghijklmnopqrstuvwxyz
Symbols	!"#\$%&'()*+,-./:;<=>?@[\] ^_`{ }~

» Related Links

- "Available Text Using the On-screen Keyboard" [p.205](#)
- "Controlling a Networked Projector Using a Web Browser" [p.188](#)

Settings on the **Image** menu let you adjust the quality of your image for the input source you are currently using. The available settings depend on the currently selected input source.

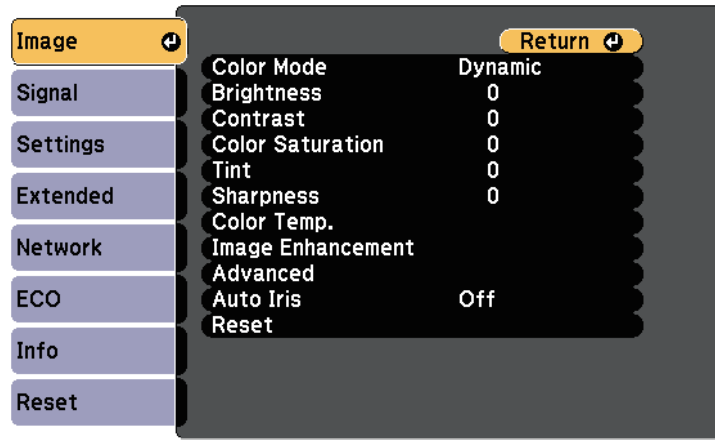

To change settings for an input source, make sure the source is connected and select that source.

Setting	Options	Description
Color Mode	See the list of available color modes	Adjusts the vividness of image colors for various image types and environments.
Brightness	Varying levels available	Lightens or darkens the overall image.
Contrast	Varying levels available	Adjusts the difference between light and dark areas of the image.
Color Saturation	Varying levels available	Adjusts the intensity of the image colors.
Tint	Varying levels available	Adjusts the balance of green to magenta tones in the image.
Sharpness	Varying levels available	Adjusts the sharpness or softness of image details.

Setting	Options	Description
Color Temp.		Sets the color tone based on color temperature. The image is tinted blue when a high value is selected and tinted red when a low value is selected.
	Color Temp.	Color Temp.: sets the color temperature according to the color mode you selected.
	Customized	Customized: adjusts the individual R (red), G (green), and B (blue) components of the offset and gain.
Image Enhancement	Noise Reduction	Reduces flickering in analog images.
Advanced		Selects the various detailed color settings:
	Gamma	Gamma: adjusts the coloring by selecting one of the gamma correction values, or referring to the projected image or a gamma graph.
	RGBCMY	RGBCMY: adjusts the hue, saturation, and brightness of each color R (red), G (green), B (blue), C (cyan), M (magenta), Y (yellow) individually.
	Deinterlacing (For interlaced signal [480i/576i/1080i] input)	Deinterlacing: sets whether or not to convert interlaced-to-progressive signals for certain video image types. <ul style="list-style-type: none"> • Off: for fast-moving video images. • Video: for most video images. • Film/Auto: for movies, computer graphics, and animation.
Auto Iris	Off Normal High Speed	Adjusts the projected luminance based on the image brightness. Available when the Color Mode is set to Dynamic or Cinema . This item is disabled when Multi-Projection is set to On . 🖱️ Extended > Multi-Projection > Multi-Projection

Setting	Options	Description
Reset	—	Resets all adjustment values except Color Mode on the Image menu to their default settings.



- The **Brightness** setting does not affect lamp brightness. To change the lamp brightness mode, use the **Power Consumption** setting in the projector's **ECO** menu.

► Related Links

- "Available Color Modes" [p.72](#)

Normally the projector automatically detects and optimizes the input signal settings. If you need to customize the settings, you can use the **Signal** menu. The available settings depend on the currently selected input source.

 You cannot select settings on the **Signal** menu when the current input source is one of the following:

- Whiteboard
- USB Display
- USB
- LAN

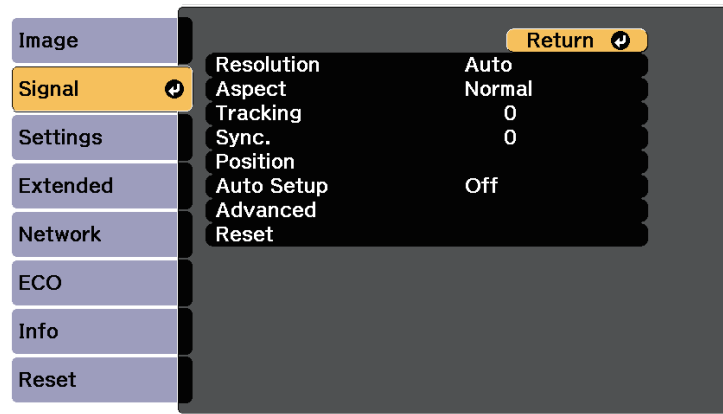

 You can restore the default settings of the **Tracking**, **Sync.**, and **Position** settings by pressing the [Auto] button on the remote control.

To change settings for an input source, make sure the source is connected and select that source.

Setting	Options	Description
Resolution	Auto Wide Normal	Sets the input signal resolution if not detected automatically using the Auto option.

Setting	Options	Description
Aspect	See the list of available aspect ratios.	Sets the aspect ratio (width-to-height ratio) for the selected input source.
Tracking	Varying levels available	Adjusts the signal to eliminate vertical stripes in computer images.
Sync.	Varying levels available	Adjusts the signal to eliminate fuzziness or flickering in computer images.
Position	—	Adjusts the image location on the screen.
Auto Setup	On Off	Automatically optimizes computer image quality (when On).
Overscan	Auto Off 4% 8%	Changes the projected image ratio to make the edges visible by a selectable percentage or automatically.
Advanced	HDMI Video Range	<p>HDMI Video Range: sets the video range to match the setting of the device connected to the HDMI port.</p> <ul style="list-style-type: none"> • Auto: detects the video range automatically. • Normal: normally for images from a device other than a computer; can also be selected if the black areas of the image are too bright. • Expanded: normally for images from a computer; can also be selected if the image is too dark.
	Input Signal	<p>Input Signal: specifies the signal type from the input sources connected to the computer ports.</p> <ul style="list-style-type: none"> • Auto: detects signals automatically. • RGB: inputs computer/RGB video signals. • Component: inputs component video signals.

Setting	Options	Description
	Video Signal	Video Signal: specifies the signal type from the input sources connected to the video ports. If interference appears or no image appears when set to Auto , select the appropriate signal according to the connected equipment.
Reset	—	Resets all adjustment values on the Signal menu to their default settings, except for the following: <ul style="list-style-type: none">• Input Signal

» Related Links

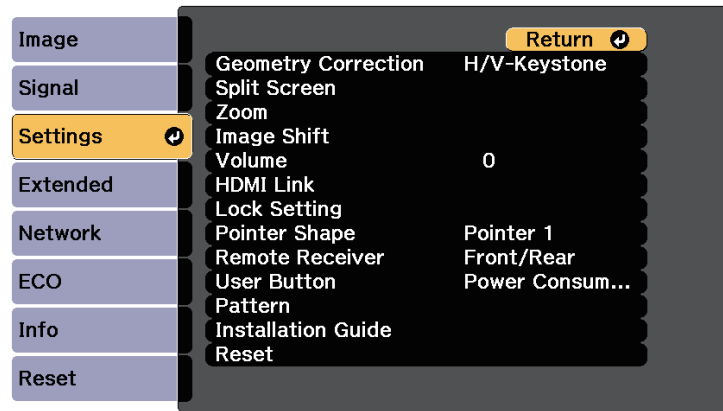

- "Available Image Aspect Ratios" [p.70](#)

Options on the **Settings** menu let you customize various projector features.



Setting	Options	Description
Geometry Correction		Adjusts image shape to rectangular.
	H/V-Keystone	H/V-Keystone: select to manually correct horizontal and vertical sides.
	Quick Corner	Quick Corner: select to correct image shape and alignment using an on-screen display.
Arc Correction		Arc Correction: corrects the corners and sides of an image projected on a curved surface.
		<ul style="list-style-type: none"> • Load Memory: loads the settings you made and saved. • Save Memory: saves the current shape of an image you have adjusted.

Setting	Options	Description
Split Screen	Screen Size	Divides the viewing area horizontally and displays two images side-by-side (press [Esc] to cancel split screen display).
	Source	
	Swap Screens	
	Audio Source	
	Align	
	Pen Mode	
	Target Pen Mode	
	Display Drawing Area	
	Display the QR Code	
	Exit Split Screen	
Zoom	Varying levels available	Adjusts the size of the projected image.
Image Shift	Varying positions available	Adjusts the position of the image without moving the projector.
Volume	Varying levels available	Adjusts the volume of projector's speaker system. Setting values are saved for each source.
HDMI Link		Adjusts the HDMI Link options:
	Device Connections	Device Connections: lists the devices connected to the HDMI ports.
	HDMI Link	HDMI Link: enables or disables the HDMI Link features.

Setting	Options	Description
	Power On Link	<p>Power On Link: controls what happens when you turn on the projector or connected device.</p> <ul style="list-style-type: none"> • Bidirectional: automatically turns on the connected device when you turn on the projector, and vice versa. • Device -> PJ: automatically turns on the projector when you turn on the connected device. • PJ -> Device: automatically turns on the connected device when you turn on the projector.
	Power Off Link	<p>Power Off Link: controls whether connected devices are turned off when you turn off the projector.</p>
	Link Buffer	<p>Link Buffer: improves the performance of the linked operations by changing the settings if the HDMI Link function is not working correctly.</p>
Lock Setting	Control Panel Lock	<p>Controls projector button locking to secure the projector:</p> <p>Full Lock: locks all buttons.</p> <p>Partial Lock: locks all buttons except the power button.</p> <p>Off: no buttons locked.</p>
Pointer Shape	Pointer 1:  Pointer 2:  Pointer 3: 	Changes the shape of the remote control pointer.
Remote Receiver	Front/Rear Front Rear Off	Limits reception of remote control signals by the selected receiver; Off turns off all receivers.

Setting	Options	Description
User Button	Power Consumption Info Deinterlacing Resolution Pattern Display Auto Calibration Display the QR Code Installation Guide	Assigns a menu option to the [User] button on the remote control for one-touch access.
Pattern		Selects various pattern display options. <div style="border: 1px solid black; padding: 5px; margin-top: 10px;"> <p>Attention</p> <p>If a pattern is displayed for a long time, a residual image may be visible in projected images.</p> </div>
	Pattern Display	<p>Pattern Display: lets you display the selected pattern type on the screen to aid in presentation.</p>
	Pattern Type	<p>Pattern Type: select from Patterns 1 to 4 or User Pattern. Patterns 1 to 4 display patterns pre-registered in the projector, such as ruled lines or grid patterns.</p>
	User Pattern	<p>User Pattern: captures a projected screen and saves it as a pattern for display.</p>
	Test Pattern	<p>Test Pattern: displays a test pattern to assist in focusing and zooming the image and correcting image shape (press the [Esc] button to cancel pattern display).</p> <div style="border: 1px solid black; padding: 5px; margin-top: 10px;"> <p>Attention</p> <p>If a pattern is displayed for a long time, a residual image may be visible in projected images.</p> </div>

Setting	Options	Description
Installation Guide	—	Displays a guide screen when installing the projector.
Reset	—	Resets all adjustment values on the Settings menu to their default settings, except for the following: <ul style="list-style-type: none">• Zoom• Image Shift• Power On Link• Power Off Link• Link Buffer• User Button

Settings on the **Extended** menu let you customize various projector setup features.

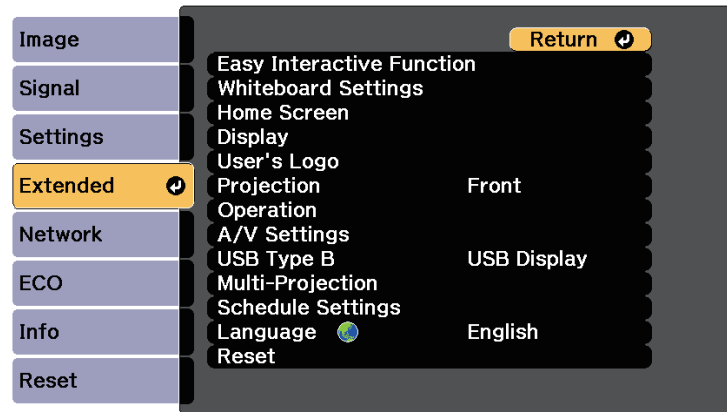

Setting	Options	Description
Easy Interactive Function	To Easy Interactive Function menu	Selects the various projector setup features when using the interactive features.
Whiteboard Settings	To Whiteboard Settings menu	Sets whiteboard mode.
Home Screen		Selects the projector's Home screen display options:
	Home Screen Auto Disp.	Home Screen Auto Disp.: select whether or not to display the Home screen automatically when there is no input signal when turning on the projector.
	Custom Setting L1	Custom Setting L1 to Custom Setting R3: select to set functions and the display as the customized Home screen.
	Custom Setting L2	
	Custom Setting L3	
	Custom Setting R1	
Custom Setting R2		
Custom Setting R3		
Display		Selects various display options:

Setting	Options	Description	
	Messages	Messages: set to On to display messages such as input source name, color mode name, aspect ratio, no signal message, or high temperature warning on your projected image. Set to Off if you do not want to display messages.	
	Display Background	Display Background: sets the screen color or logo to display when no signal is received.	
	Startup Screen	Startup Screen: set to On to display a logo when the projector starts up.	
	A/V Mute	A/V Mute: sets the screen color or logo to display when A/V Mute is turned on.	
	Color Uniformity		Color Uniformity: set to On to adjust the color tone balance for the whole screen.
			<ul style="list-style-type: none"> • Adjustment Level: set the adjustment level. • Start Adjustments: select the area for which you want to adjust the color tone for red, green, and blue individually.
		Toolbars	Toolbars: select whether or not to always display the drawing toolbar when using the interactive features. The default is Hide for Set Time .
	Pen Mode Icon	Pen Mode Icon: set to On to display the icon to change the pen mode when using the interactive features.	
Projector Control	Projector Control: set to On to display the bottom toolbar, annotation mode tabs, and whiteboard mode tabs when using the interactive features.		
User's Logo	—	Creates a screen that the projector displays to identify itself and enhance security.	

Setting	Options	Description
Projection	Front	Selects the way the projector faces the screen so the image is oriented correctly.
	Front/Upside Down	
	Rear	
	Rear/Upside Down	
Operation		Selects various operation options:
	Direct Power On	Direct Power On: lets you turn on the projector by plugging it in without pressing the power button.
	High Altitude Mode	High Altitude Mode: regulates the projector's operating temperature at altitudes above 1500 m.
	Auto Source Search	Auto Source Search: set to On to detect the input signal automatically and project images when there is no input signal.
	Auto Power On	Auto Power On: select the image source from which you want to automatically start projection. When the projector detects the input signal from the selected image source, it projects automatically in standby mode.
	Date & Time	<p>Date & Time: adjusts the projector's system time and date settings.</p> <ul style="list-style-type: none"> • Daylight Saving Time: set to On to activate daylight saving time. • Internet Time: set to On to update the time automatically through an Internet time server.
A/V Settings		Selects various audio and video output settings:
	A/V Output	<p>A/V Output: set to Always On to output audio and images to external devices when the projector is in standby mode. (Set Standby Mode to Communication On in the projector's ECO menu first.)</p>

Setting	Options	Description
	Audio Output	Audio Output: selects the audio input port when projecting images from anything except for HDMI ports.
	HDMI1 Audio Output HDMI2 Audio Output	HDMI1 Audio Output/HDMI2 Audio Output: selects the audio input port when projecting images from HDMI ports.
	DVI Output	DVI Output: selects an image source to display on the DVI monitor connected to the projector. Select Whiteboard to display the whiteboard screen. Select Projected Image to display the currently projected image source.
	HDMI2 Out (Split Screen)	HDMI2 Out (Split Screen): When performing split screen projection, and if you do not want to display images from the HDMI2 port, select Off .
USB Type B	Easy Interactive Function	Easy Interactive Function: select to set the interactive features to operate computers (computer interactive mode). USB Display and Wireless Mouse functions are not available.
	USB Display/Easy Interactive Function	USB Display/Easy Interactive Function: select to set the interactive features to operate computers (computer interactive mode) and USB Display. The Wireless Mouse function is not available.
	Wireless Mouse/USB Display	Wireless Mouse/USB Display: select to use the Wireless Mouse function and USB Display. You cannot use the interactive features to operate computers (computer interactive mode).
Multi-Projection		Make settings when projecting from multiple projectors:

Setting	Options	Description
	Multi-Projection	Multi-Projection: set to On to match the display quality of multiple projectors. When set to On , the following are automatically set to prevent unevenness on the right and left screens. <ul style="list-style-type: none"> ☑ Image > Auto Iris > Off ☑ ECO > Power Consumption > Normal ☑ ECO > Light Optimizer > Off
	Projector ID	Projector ID: assigns an ID for the projector when you use multiple projectors.
	Color Mode	Color Mode: adjusts the vividness of image colors for various image types and environments. When using multiple projectors, make sure you select the same color mode for all of the projectors.
	Color Uniformity	Color Uniformity: adjusts the color tone balance for the whole screen.
	Brightness Level	Brightness Level: sets the lamp brightness level between 1 and 5 when the brightness of each lamp differs. This item can be adjusted only when Power Consumption is set to Normal in the ECO menu.
	Color Matching	Color Matching: corrects the difference between the tint and brightness of each projected image.
	RGBCMY	RGBCMY: adjusts the Hue, Saturation, and Brightness for R (Red), G (Green), B (Blue), C (Cyan), M (Magenta), and Y (Yellow) color components.
	Reset	Reset: resets all adjustment values for the Multi-Projection menu to their default settings.
Schedule Settings	To Schedule Settings menu	Schedules projector events to occur automatically at selected dates and times.

Setting	Options	Description
Language	Various languages available	Select the language for projector menu and message displays.
Reset	—	Resets all adjustment values on the Extended menu to their default settings, except for the following: <ul style="list-style-type: none"> • Easy Interactive Function • Toolbars • Pen Mode Icon • Projector Control • User's Logo • Projection • High Altitude Mode • Auto Source Search • Date & Time • A/V Output • DVI Output • USB Type B • Multi-Projection • Projector ID • Color Mode • Color Matching • Schedule Settings • Language



When you set **User's Logo Protection** to **On** in the **Password Protection** screen, you cannot change settings related to user's logo display (**Display Background**, **Startup Screen**, **A/V Mute** in the **Display** setting). Set **User's Logo Protection** to **Off** first.

» **Related Links**

- "Extended Menu - Easy Interactive Function Menu" [p.216](#)
- "Extended Menu - Whiteboard Settings Menu" [p.218](#)
- "Selecting Password Security Types" [p.168](#)

Extended Menu - Easy Interactive Function Menu

Settings on the **Easy Interactive Function** menu let you customize various projector setup features when using the interactive features.

» Related Links

- "General" [p.216](#)
- "PC Interactive" [p.217](#)

General

Settings on the **General** section let you set various settings when using the interactive features.

☛ **Extended > Easy Interactive Function > General**

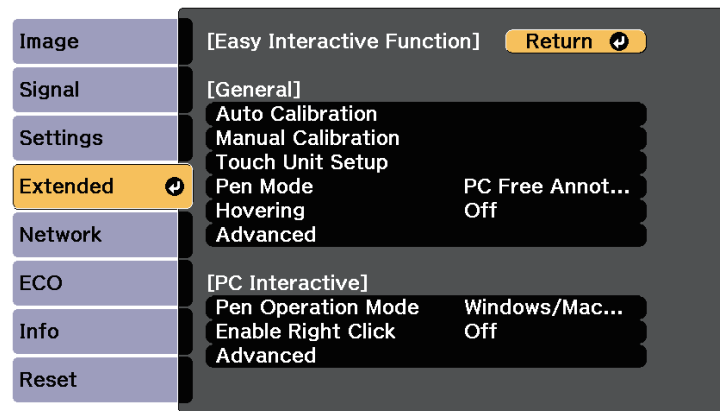

Setting	Options	Description
Auto Calibration	—	Starts calibration for pen operations.
Manual Calibration		
Touch Unit Setup *		Selects settings for the Touch unit.
	Installation Pattern	Installation Pattern: displays reference points to help you determine the installation position of the Touch Unit.

Setting	Options	Description
	Power	Power: turns on the Touch Unit power.
	Angle Adjustment	Angle Adjustment: performs angle adjustment for laser diffusion.
	Touch Calibration	Touch Calibration: performs calibration for touch operations with your finger.
Pen Mode	PC Free Annotation PC Interactive	Selects the mode for the interactive pens. When set to PC Free Annotation , you can draw on the projected screen. When set to PC Interactive , you can operate a computer from the projected screen.
Hovering	On Off	When set to On , the pointer follows the pen tip as you hover it over the screen and move it around.
Advanced (Advanced section)	Distance of Projectors	Distance of Projectors: select Mode 2 . If the distance between the projectors is longer than 2 m, or if the interactive pen operation is unstable in Mode 2 , select Mode 1 .
	Sync of Projectors	Sync of Projectors: if the projectors are connected using the optional remote control cable set, select Wired .
	Multi-Projection	Multi-Projection: selects the position (right or left) for each projected screen when you set your projector's interactive features with two projectors installed side by side.
	Wired Sync Mode	Wired Sync Mode: if the projectors are not connected using the optional remote cable set, or if the interactive pen operation is unstable in Mode 1 , select Mode 2 .
	Preset Pen Thickness	Preset Pen Thickness: selects Normal or Thin as the line thickness from thin width or thick width.

Setting	Options	Description
	Eraser Size	Eraser Size: selects Normal or Large as the erasable area from thin width or thick width.
	Color Palette	Color Palette: allows you to select Palette 2 if certain colors in the default color palette are difficult to see.
Advanced (PC Free Annotation section)	Pen Button Function	Pen Button Function: sets the function of the button on the side of the interactive pen in annotation mode.
	Default Touch Action	Default Touch Action: allows you to select whether to activate Eraser or PC Interactive when you switch to annotation mode.
	Confirm Clear Screen	Confirm Clear Screen: when set to On , a confirmation screen is displayed before clearing all the content drawn on the projected screen.

* Available only for EB-1450Ui.

PC Interactive

Settings on the **PC Interactive** section let you set various settings when you want to operate a computer from the projected screen.

Extended > Easy Interactive Function > PC Interactive

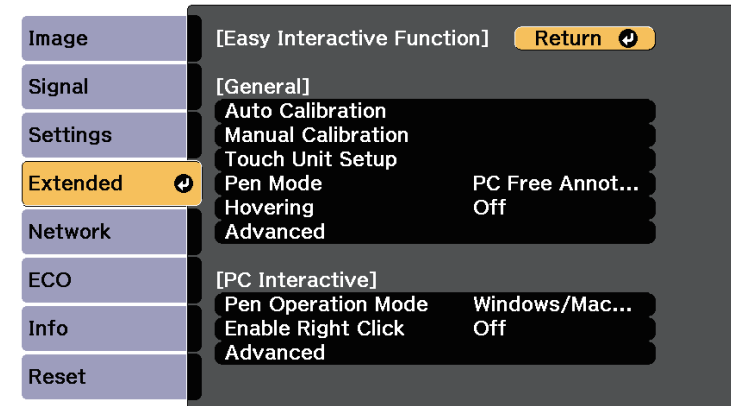

Setting	Options	Description
Pen Operation Mode		Selects the operation mode for interactive pen or your finger according to the operating system on your computer.
	Windows/Mac Mode	Windows/Mac Mode: when using Windows or Mac.
	Ubuntu Mode	Ubuntu Mode: when using Ubuntu. When selecting this mode, you cannot use the Windows' ink functionality using the interactive pen.
Enable Right Click	On Off	When set to On , a long press by the pen tip or finger acts as a right-click operation. (Only available when Pen Operation Mode is set to Ubuntu Mode .)
Advanced	Pen Tip Button	Pen Tip Button: assigns either Right Click or Left Click to the pen tip. (Only available when Pen Operation Mode is set to Ubuntu Mode .)

Setting	Options	Description
	Auto Adjust Pen Area	Auto Adjust Pen Area: when set to On , the pen area is automatically adjusted as the resolution for the connected computer changes. Set to Off if you do not want to automatically adjust the pen area that has been manually adjusted.
	Manual Adj. Pen Area	Manual Adj. Pen Area: adjusts the pen area manually.

» **Related Links**

- "Connecting Multiple Projectors of the Same Model" [p.40](#)

Extended Menu - Whiteboard Settings Menu

Settings on the **Whiteboard Settings** menu let you customize various settings when using whiteboard mode.



When you set **Whiteboard Protection** to **On** in the Password Protection screen, you cannot change settings on the **Whiteboard Settings** menu. Set **Whiteboard Protection** to **Off**.

» **Related Links**

- "Whiteboard Settings Menu - Basic Menu" [p.218](#)
- "Whiteboard Settings Menu - Policy Menu" [p.219](#)
- "Whiteboard Settings Menu - Print Menu" [p.220](#)
- "Whiteboard Settings Menu - Save Menu" [p.220](#)
- "Whiteboard Settings Menu - Mail Menu" [p.221](#)
- "Whiteboard Settings Menu - Directory Menu" [p.222](#)
- "Whiteboard Settings Menu - Reset Menu" [p.224](#)

Whiteboard Settings Menu - Basic Menu

Settings on the **Basic** menu let you select the basic whiteboard mode settings.

☛ **Extended > Whiteboard Settings > Basic**

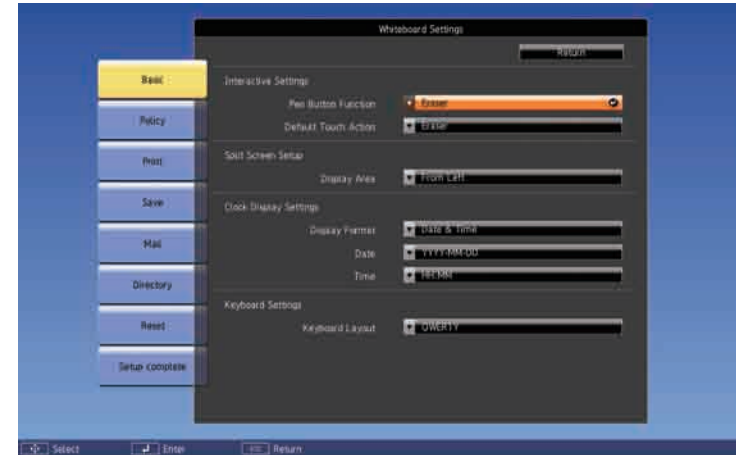

Setting	Options	Description
Interactive Settings		Selects interactive settings for whiteboard mode.
	Pen Button Function	Pen Button Function: sets the function of the button on the side of the interactive pen in whiteboard mode.
	Default Touch Action	Default Touch Action: allows you to select whether to activate Eraser or Selection Tool when you switch to whiteboard mode.

Setting	Options	Description
Split Screen Setup	Display Area	<p>Sets the displayed area of the whiteboard screen when you split the screen using the annotation mode or whiteboard mode tabs.</p> <p>From Left: displays the left side of the whiteboard screen when you split the screen from the right or left side.</p> <p>From Right: displays the right side of the whiteboard screen when you split the screen from the right or left side.</p> <p>No Adjustments: displays the right side of the whiteboard screen when you split the screen from the right side, and the left side of the whiteboard screen when you split the screen from the left side.</p>
Clock Display Settings	Display Format Date Time	<p>Sets the date and time display on the whiteboard mode bottom toolbar. Set the date and time in Date & Time in the projector's Extended menu.</p> <p>☛ Extended > Operation > Date & Time</p>
Keyboard Settings	Keyboard Layout	Selects the on-screen keyboard layout.

Whiteboard Settings Menu - Policy Menu

Settings on the **Policy** menu let you select the policy settings.

☛ Extended > Whiteboard Settings > Policy



Setting	Options	Description
Policy Setting	Capture Print Scan USB Storage PC via USB Cable Network Folder Mail Shared Whiteboard	Enables or disables features. All features are enabled by default.
Template Settings	Protect User Templates	When set to On , the user templates can only be changed through the Web browser interface. When set to Off , you can set the user templates in whiteboard mode or from a Web browser.

Setting	Options	Description
Internal Storage	Auto Delete Saved Data	Auto Delete Saved Data: selects whether or not to delete the current drawing contents on the whiteboard when turning off the projector. Select Clear to delete the drawing contents on the whiteboard. Select Retain to save the drawing contents on the whiteboard.
	Delete All Internal Data	Delete All Internal Data: Select Execute to delete the internal storage data.

Whiteboard Settings Menu - Print Menu

Settings on the **Print** menu let you select the print settings.

☛ **Extended > Whiteboard Settings > Print**



Setting	Options	Description
Default Printer	USB Network	Sets the default printer used when printing. The selected printer is displayed as the default in whiteboard mode and is used automatically in annotation mode.
Print Function		Selects printing options.
	Quality	Quality: sets the default print quality.
	Paper Size	Paper Size: sets the default paper size. (A4 , A3 , or Letter)
Scan Function	Rotate After Scanning	Rotates the scanned image to project in the same orientation as when scanning when set to On .
Network Printer Settings		Configures your network printer.
	IP Address	IP Address: enter the IP address for the network printer, using 0 to 255 for each address field. You cannot use the following IP addresses: 127.x.x.x, 192.0.2.x, or 224.0.0.0 through 255.255.255.255 (where x is a number from 0 to 255). To return the IP address to its default value, enter 0.0.0.0.
	Printer Type	Printer Type: sets the type of connected printer. In most cases, you should leave this as Auto Detect .
	Job username	Job username: sets the user name for print jobs. Projector name is set as default. You can enter up to 31 alphanumeric characters (you cannot use : and spaces).
	Test Print	Test Print: prints a test page.

Whiteboard Settings Menu - Save Menu

Settings on the **Save** menu let you select the save settings.

Extended > Whiteboard Settings > Save



Setting	Options	Description
Default Save Location	USB Network	Sets the default save location for drawing data. The selected location is displayed as the default in whiteboard mode and is used automatically in annotation mode.
Always apply password	On Off	Set to On to always set a password on a file. When set to On , you can save files only in whiteboard mode and as a PDF or EWF format.
Network Folder Settings		Sets the network folder.

Setting	Options	Description
	CIFS Server	CIFS Server: enter the IP address or FQDN (Fully Qualified Domain Name) for the CIFS server. You can enter up to 63 alphanumeric characters (you cannot use " * + , ; < = > ? [\] ` and spaces). You cannot use the following IP addresses: 127.x.x.x, 192.9.2.x, or 224.0.0.0 through 255.255.255.255 (where x is a number from 0 to 255). If you specify an FQDN, you must configure a DNS server.
	Shared Folder Path	Shared Folder Path: sets the network folder name in "share name\folder name". You can enter up to 63 alphanumeric characters (you cannot use " * / : < > ? and).
	User name	User name: enter a user name that will have read/write privileges on the network folder. You can enter up to 64 alphanumeric characters (you cannot use : and spaces). You can enter a domain name by adding it before the user name and separating them with a backslash (domain\username).
	Password	Password: enter a password for the user name. You can enter up to 64 alphanumeric characters (you cannot use : and spaces). After you enter the password and select Setup complete , the password is displayed as an asterisk (*).
	Check Connection	Check Connection: tests the network connection.

Whiteboard Settings Menu - Mail Menu

Settings on the **Mail** menu let you select the email settings.

Extended > Whiteboard Settings > Mail

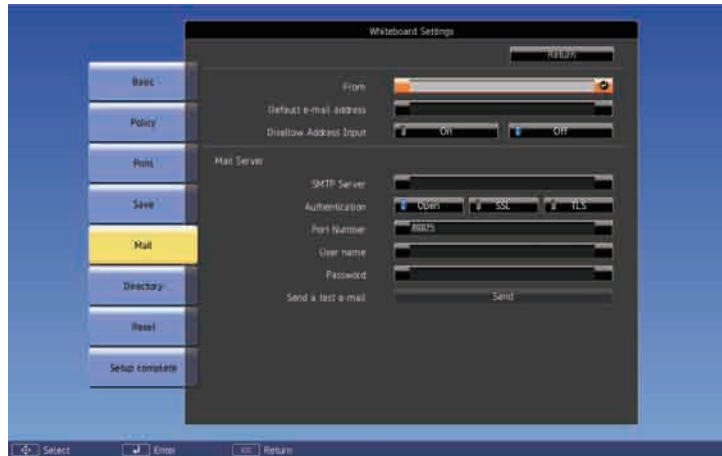

Setting	Options	Description
	SMTP Server	SMTP Server: enter the IP address or FQDN (Fully Qualified Domain Name) for the mail server. You can enter up to 63 alphanumeric characters (you cannot use " * + , ; < = > ? [\] ` and spaces). You cannot use the following IP addresses: 127.x.x.x, 192.0.2.x, or 224.0.0.0 through 255.255.255.255 (where x is a number from 0 to 255). If you specify an FQDN, you must configure a DNS server.
	Authentication	Authentication: sets the type of authentication expected by the mail server.
	Port Number	Port Number: The default port varies depending on the Authentication setting: 25 for Open , 465 for SSL , and 587 for TLS .
	User name	User name: enter a user name for the mail server. You can enter up to 64 alphanumeric characters (you cannot use : and spaces).
	Password	Password: enter a password for the mail server. You can enter up to 64 alphanumeric characters (you cannot use : and spaces).
	Send a test e-mail	Send a test e-mail: connects to the SMTP server and sends a test email to the address you set as the default.

Setting	Options	Description
From	Up to 64 alphanumeric characters (do not use " () , ; ; < > [\] : spaces)	Enter the email address to be displayed to the sender.
Default e-mail address	Up to 64 alphanumeric characters (do not use " () , ; ; < > [\] : spaces)	Enter the default email address used to send emails. You can also specify the domain name following an at mark to aid email address input; for example, "@exc.epson.co.jp".
Disallow Address Input	On Off	Set to On to choose e-mail addresses only from an address book or directory service.
Mail Server		Configures your mail server.

Whiteboard Settings Menu - Directory Menu

Settings on the **Directory** menu let you select the directory service settings.

Extended > Whiteboard Settings > Directory Settings



Setting	Options	Description
Enable Directory Access	On Off	Set to On to search for user names and email addresses from a directory service.
Search Base DN	Up to 63 alphanumeric characters (do not use : and spaces)	Specify the DN (Distinguished Name) where the search for user names and email addresses should start. Make sure you specify all OU (Organizational Unit) and DC (Domain Component) as necessary in the order of OU then DC; for example, "OU=accounts,DC=example,DC=com". The DN must be at or below the DC level in the database structure.
User Attributes	Up to 63 alphanumeric characters (do not use : and spaces)	Specify the attribute for user name; for example, "cn".

Setting	Options	Description
Mail Attributes	Up to 63 alphanumeric characters (do not use : and spaces)	Specify the attribute for mail address; for example, "mail".
Directory Server Settings		Configures your directory server.
	LDAP Server	LDAP Server: enter the IP address or FQDN (Fully Qualified Domain Name) for the LDAP server. You can enter up to 63 alphanumeric characters (you cannot use " * + , ; < = > ? [\] ` and spaces). You cannot use the following IP addresses: 127.x.x.x, 192.9.2.x, or 224.0.0.0 through 255.255.255.255 (where x is a number from 0 to 255). If you specify an FQDN, you must configure a DNS server.
	Port Number	Port Number: enter a port number for the LDAP server. The default port is 389.
	Authentication	Authentication: sets the type of authentication expected by the LDAP server. If you want to select Digest-MD5 as an authentication method when an IP address is set for LDAP Server , you must configure the DNS server to enable reverse DNS lookup.
	User name	User name: enter a user name for the LDAP server. You can enter up to 64 alphanumeric characters (you cannot use : and spaces).
	Password	Password: enter a password for the LDAP server. You can enter up to 64 alphanumeric characters (you cannot use : and spaces).
	Check Connection	Check Connection: tests the network connection.

Whiteboard Settings Menu - Reset Menu

Settings on the **Reset** menu let you return all of the Whiteboard Settings menu items to the default settings.

☛ **Extended > Whiteboard Settings > Reset**

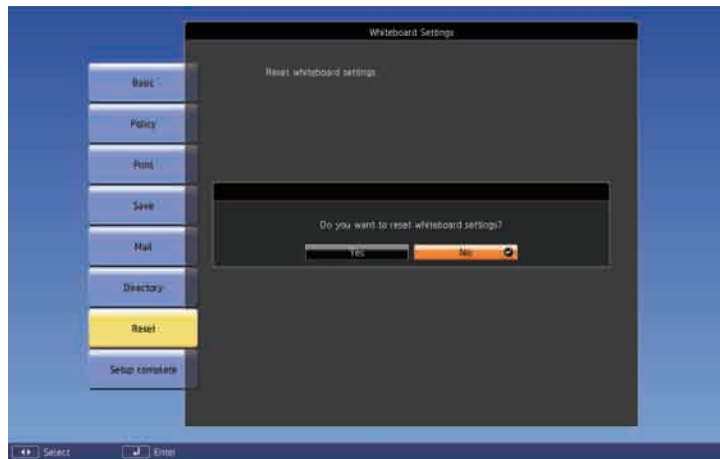

The following data saved in the internal storage is deleted.

- Template information
- Address book
- Shared whiteboard connection logs

Settings on the **Network** menu let you view network information and set up the projector for controlling over a network.

When you set **Network Protection** to **On** in the **Password Protection** screen, you cannot change the network settings. Set **Network Protection** to **Off** first.

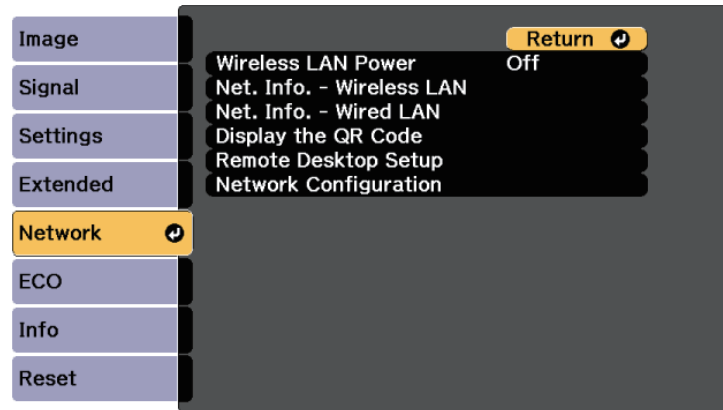

Setting	Options	Description
Wireless LAN Power	On Off	Configures your wireless LAN settings. Select On to project images via a wireless LAN. If you do not want to connect via wireless LAN, turn it off to prevent unauthorized access by others.
Net. Info. - Wireless LAN	Connection Mode Wireless LAN Sys. Antenna Level Projector Name SSID DHCP IP Address Subnet Mask Gateway Address MAC Address Region Code	Displays wireless network status and details.

Setting	Options	Description
Net. Info. - Wired LAN	Projector Name DHCP IP Address Subnet Mask Gateway Address MAC Address	Displays wired network status and details.
Display the QR Code	—	Displays a QR code for connecting with iOS or Android devices using the Epson iProjection app.
Remote Desktop Setup		Configures settings for remote desktop connection.
	Address	Address: enter the remote computer's IP address or FQDN (Fully Qualified Domain Name) for the remote desktop connection. You can enter up to 32 alphanumeric characters. To input more than 32 characters, use your Web browser. If you specify an FQDN, you must configure a DNS server. You can enter a port number by adding it after the IP address or FQDN and separating them with a colon (IP address or FQDN:port number).
	User name	User name: enter a user name for the remote computer. You can enter up to 32 alphanumeric characters. You can enter a domain name by adding it before the user name and separating them with a backslash (domain\username).
	Password	Password: enter a password for the remote computer. You can enter up to 32 alphanumeric characters.
Network Configuration	To additional network menus	Configures your network settings.



Once you have connected your projector to your network, you can select projector settings and control projection using a compatible Web browser. This allows you to access the projector remotely.

► **Related Links**

- "Network Menu - Basic Menu" [p.226](#)
- "Network Menu - Wireless LAN Menu" [p.227](#)
- "Network Menu - Wired LAN Menu" [p.229](#)
- "Network Menu - Notifications Menu" [p.230](#)
- "Network Menu - Others Menu" [p.231](#)
- "Network Menu - Reset Menu" [p.231](#)
- "Selecting Password Security Types" [p.168](#)

Network Menu - Basic Menu

Settings on the **Basic** menu let you select the basic network settings.

☛ **Network > Network Configuration > Basic**

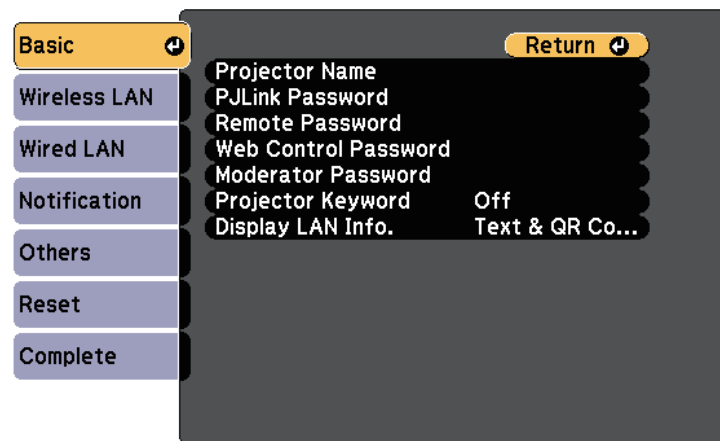

Setting	Options	Description
Projector Name	Up to 16 alphanumeric characters (do not use " * + , / ; < = > ? [\] ` spaces)	Enter a name to identify the projector over the network.
PJLink Password	Up to 32 alphanumeric characters	Enter a password for using the PJLink protocol for projector control.
Remote Password	Up to 8 alphanumeric characters (do not use * : spaces)	Enter a password for accessing the projector using the Web Remote. (User name is EPSONREMOTE ; default password is guest .)
Web Control Password	Up to 8 alphanumeric characters (do not use * : spaces)	Enter a password for accessing the projector over the Web. (User name is EPSONWEB ; default password is admin .)
Moderator Password	Four-digit number	Enter a password for accessing the projector as a moderator using EasyMP Multi PC Projection or Epson iProjection. (No password is set by default.)
Projector Keyword	On Off	Set to On to enable a security password to prevent access to the projector by anyone not in the same room as the projector. You must enter the random keyword displayed from a computer using EasyMP Multi PC Projection or Epson iProjection to access the projector and share the current screen.

Setting	Options	Description
Display LAN Info.	Text & QR Code Text	Set the display format for the projector's network information. By simply reading the QR code with Epson iProjection, you can connect the mobile device to the projector through a network. The default value is Text & QR Code .

Network Menu - Wireless LAN Menu

Settings on the **Wireless LAN** menu let you select the wireless LAN settings.

☛ **Network > Network Configuration > Wireless LAN**

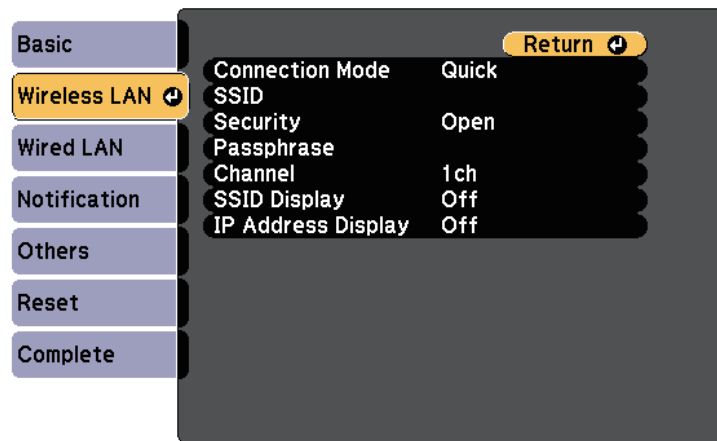

Setting	Options	Description
Connection Mode		Select the type of wireless connection:

Setting	Options	Description
	Quick	Quick: lets you connect to multiple smartphones, tablets, or computers directly using wireless communication. Use EasyMP Multi PC Projection to connect in this connection mode. The projector acts as an easy access point. (We recommend limiting the number of devices to six or less to maintain the projection performance.)
	Advanced	Advanced: lets you connect to multiple smartphones, tablets, or computers over a wireless network access point.
Search Access Point	To Search View	Search for available wireless network access points in Advanced connection mode. Depending on the access point settings, they may not be displayed in the list.
SSID	Up to 32 alphanumeric characters	Sets the SSID (network name) of the wireless LAN system the projector is connecting to.
Security		Selects the type of security used on the wireless network. When setting security, follow the instructions from the administrator of the network system you want to connect to.
	Open	Open: security is not set.
	WPA2-PSK	WPA2-PSK: communication is performed using WPA2 security. Uses AES method for encryption. When establishing a connection from a computer to the projector, enter the value set in the passphrase.
	WPA/WPA2-PSK	WPA/WPA2-PSK: connects in WPA personal mode. Encryption method is selected automatically according to the access point settings. Set a passphrase which is the same for the access point.

Setting	Options	Description
	WPA2-EAP	WPA2-EAP: communication is performed using WPA2 security. Uses AES method for encryption.
	WPA/WPA2-EAP	WPA/WPA2-EAP: connects in WPA enterprise mode. The encryption method is selected automatically according to the access point settings.
Passphrase	Various passphrases from 8 to 32 characters (when entering from a Web browser: various passphrases from 8 to 63 characters)	For WPA2-PSK and WPA/WPA2-PSK security, selects the pre-shared passphrase used on the network. When the passphrase is entered and the [Enter] button is pressed, the value is set and displayed as an asterisk (*). We recommend changing the passphrase periodically for security. If the network settings are initialized, it returns to the initial passphrase.
EAP Method		Set the EAP settings for WPA2-EAP and WPA/WPA2-EAP security.
	EAP Type	EAP Type: selects the protocol for authentication. <ul style="list-style-type: none"> • PEAP: authentication protocol widely used in Windows Server. • PEAP-TLS: authentication protocol used in Windows Server. Select this when using a client certificate. • EAP-TLS: authentication protocol widely used to use a client certificate. • EAP-FAST, LEAP: select this when these authentication protocols are used.

Setting	Options	Description
	User name	User name: enter up to 63 alphanumeric characters. You can enter up to 32 alphanumeric characters in the projector menu. To enter more than 32 characters, use your Web browser. You can enter a domain name by adding it before the user name and separating them with a backslash (domain\username). When importing a client certificate, the name the certificate was issued to is automatically set.
	Password	Password: enter a password up to 63 alphanumeric characters for authentication when using the PEAP , EAP-FAST , or LEAP type. You can enter up to 32 alphanumeric characters in the projector menu. To input more than 32 characters, use your Web browser. After you enter the password and select Finish , the password is displayed as an asterisk (*).
	Client Certificate	Client Certificate: imports the client certificate when using the PEAP-TLS or EAP-TLS type.
	Verify Server Cert.	Verify Server Cert.: selects whether to verify the server certificate when a CA certificate has been set.
	CA certificate	CA certificate: imports the CA certificate when using the PEAP , PEAP-TLS , EAP-TLS , or EAP-FAST type.
	RADIUS Server Name	RADIUS Server Name: enter the server name to verify. You can enter up to 32 alphanumeric characters.
Channel	1ch 6ch 11ch	In Quick connection mode, selects the frequency band (channel) used by the wireless LAN.

Setting	Options	Description
IP Settings	DHCP IP Address Subnet Mask Gateway Address	DHCP: set to On if your network assigns addresses automatically; set to Off to manually enter the network's IP Address, Subnet Mask, and Gateway Address using 0 to 255 for each address field. Do not use these addresses: 0.0.0.0, 127.x.x.x, 192.0.2.x or 224.0.0.0 through 255.255.255.255 (where x is a number from 0 to 255) for IP Address, 255.255.255.255 or 0.0.0.0 through 254.255.255.255 for Subnet Mask, and 0.0.0.0, 127.x.x.x or 224.0.0.0 through 255.255.255.255 for Gateway Address.
	DNS Server 1 DNS Server 2	DNS Server 1/DNS Server 2: enter the IP address for the DNS server, using 0 to 255 for each address field. The DNS server resolves the host name. You cannot use the following IP addresses: 127.x.x.x (where x is a number from 0 to 255). When these settings are not set, DNS server information is acquired using DHCP.
SSID Display	On Off	Select whether to display the SSID on the network standby screen and Home screen.
IP Address Display	On Off	Select whether to display the IP address on the network standby screen and Home screen.

Network > Network Configuration > Wired LAN

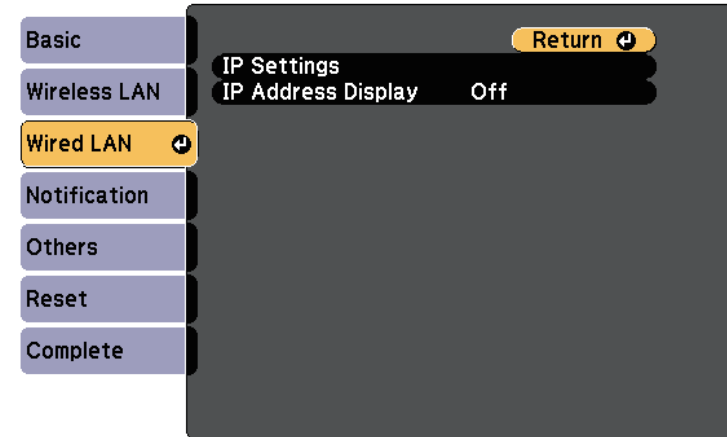

Setting	Options	Description
IP Settings	DHCP IP Address Subnet Mask Gateway Address	DHCP: set to On if your network assigns addresses automatically; set to Off to manually enter the network's IP Address, Subnet Mask, and Gateway Address using 0 to 255 for each address field.
	DNS Server 1 DNS Server 2	DNS Server 1/DNS Server 2: enter the IP address for the DNS server, using 0 to 255 for each address field. The DNS server resolves the host name. You cannot use the following IP addresses: 127.x.x.x (where x is a number from 0 to 255). When these settings are not set, DNS server information is acquired using DHCP.
IP Address Display	On Off	Select whether to display the IP address on the network standby screen.

Network Menu - Wired LAN Menu

Settings on the **Wired LAN** menu let you select the wired LAN settings.

Network Menu - Notifications Menu

Settings on the **Notifications** menu let you receive an email notification if a problem or warning occurs in the projector.

☛ **Network > Network Configuration > Notifications**

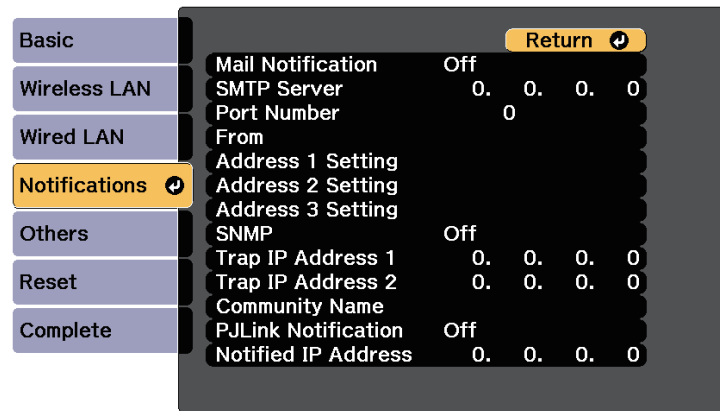

Setting	Options	Description
Mail Notification	On Off	Set to On to send an email to the preset addresses when a problem or warning occurs with a projector.
SMTP Server	IP address	Enter the IP address for the projector's SMTP server using 0 to 255 for each address field. Do not use these addresses: 127.x.x.x, 192.0.2.x or 224.0.0.0 through 255.255.255.255 (where x is a number from 0 to 255).
Port Number	1 to 65535 (default is 25)	Select a number for the SMTP server Port Number.

Setting	Options	Description
From	Up to 32 alphanumeric characters Up to 64 alphanumeric characters from the Web browser (do not use " () , ; < > [\] spaces)	Enter the email address of the sender.
Address 1 Setting		Enter the e-mail address, and select the alerts you want to receive. Repeat for up to 3 addresses.
Address 2 Setting Address 3 Setting		
SNMP	On Off	Set to On to monitor the projector using SNMP. To monitor the projector, you need to install the SNMP manager program on your computer. SNMP should be managed by a network administrator. The default value is Off .
Trap IP Address 1 Trap IP Address 2	IP address	Enter up to two IP addresses to receive SNMP notifications, using 0 to 255 for each address field. Do not use these addresses: 127.x.x.x or 224.0.0.0 through 255.255.255.255 (where x is a number from 0 to 255).
Community Name	Up to 32 alphanumeric characters (do not use spaces and any symbols other than @)	Set the SNMP community name.
PLink Notification	On Off	Enables or disables the PLink notification function.

Setting	Options	Description
Notified IP Address	IP address	Enter the IP address to receive the projector's operating status when the PjLink notification function is enabled. Enter the addresses using 0 to 255 for each address field. Do not use these addresses: 127.x.x.x or 224.0.0.0 through 255.255.255.255 (where x is a number from 0 to 255).

Setting	Options	Description
Web Server Cert.	—	Imports the Web server certificate for secure HTTP.
Priority Gateway	Wired LAN Wireless LAN	You can set the priority gateway.
AMX Device Discovery	On Off	Set to On when you want to allow the projector to be detected by AMX Device Discovery.
Crestron RoomView	On Off	Set to On only when monitoring or controlling the projector over the network using Crestron RoomView. Enabling Crestron RoomView disables the Epson Message Broadcasting feature in the EasyMP Monitor software.
Control4 SDDP	On Off	Set to On to allow device information to be acquired using Control4 Simple Device Discovery Protocol (SDDP).
Message Broadcasting	On Off	Set to On to enable EPSON Message Broadcasting feature. You can download Message Broadcasting and its Operation Guide from the following Web site. http://www.epson.com/

Network Menu - Others Menu

Settings on the **Others** menu let you select other network settings.

☛ **Network > Network Configuration > Others**

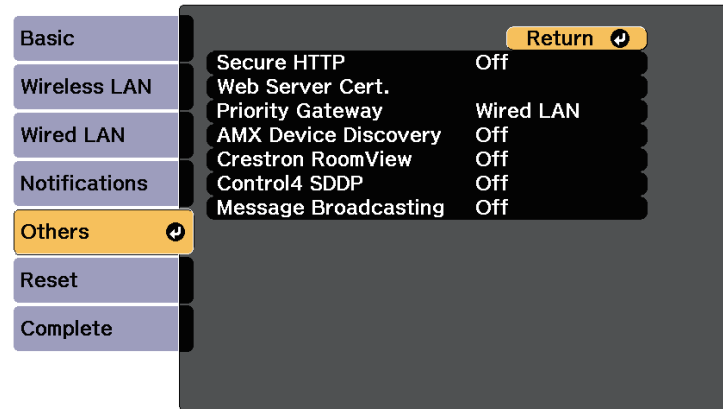

Setting	Options	Description
Secure HTTP	On Off	To strengthen security, communication between the projector and computer in Web control is encrypted. When setting security with Web control, it is recommended to set this to On .

Network Menu - Reset Menu

Settings on the **Reset** menu let you reset all of the network settings.

☛ Network > Network Configuration > Reset

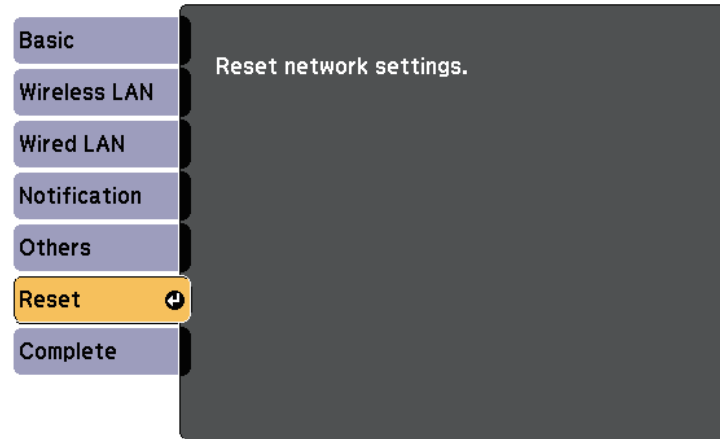

Setting	Options	Description
Reset network settings.	Yes No	Select Yes to reset all network settings.

Settings on the **ECO** menu let you customize projector functions to save power.

When you select a power-saving setting, a leaf icon appears next to the menu item.

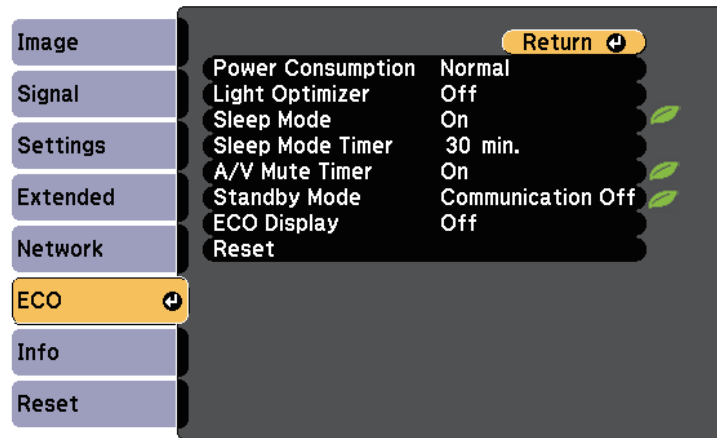

Setting	Options	Description
Power Consumption		Selects the brightness mode of the projector lamp. You cannot select settings when you use your projector at high altitude or in locations subject to high temperatures. This item is disabled when Multi-Projection is set to On . ☛ Extended > Multi-Projection > Multi-Projection
	Auto	Auto : sets the projector to sense the optimum lamp brightness needed and adjusts the lamp's brightness accordingly. This item is enabled only when you install the projector upside-down.
	Normal	Normal : sets maximum lamp brightness.

Setting	Options	Description
	ECO	ECO : reduces lamp brightness and fan noise, and saves power and lamp life.
Light Optimizer	On Off	When set to On , the lamp brightness is adjusted according to the projected image. This helps to reduce the power consumption by lowering the lamp brightness according to the scene being projected. The setting is stored for each Color Mode. This item is enabled when: <ul style="list-style-type: none"> • Power Consumption is set to Normal or Auto. • Auto Iris is set to Off. ☛ Image > Auto Iris • Multi-Projection is set to Off. ☛ Extended > Multi-Projection > Multi-Projection
Sleep Mode	On Off	Automatically turns off the projector after an interval of inactivity (when On).
Sleep Mode Timer	1 to 30 minutes	Sets the interval for Sleep Mode.
A/V Mute Timer	On Off	Automatically turns off the projector after 30 minutes if A/V Mute is enabled (when On).
Standby Mode	Communication On Communication Off	Communication On indicates that the projector can be monitored over a network when the projector is in standby mode. Enable this setting to allow the following operations to occur when the projector is in standby mode: <ul style="list-style-type: none"> • Monitor and control the projector over a network • Output audio and images to an external device (only when A/V Output is set to Always On)

Setting	Options	Description
ECO Display	On Off	Displays a leaf icon in the bottom left corner of the projected screen to indicate the power-saving status when the lamp brightness changes (when On).
Reset	—	Resets all adjustment values on the ECO menu to their default settings, except for Standby Mode .



- When the **Sleep Mode Timer** setting is enabled, the lamp dims for a short time before the timer limit is reached and the projector turns off.

» Related Links

- "Projector Setup Settings - Extended Menu" [p.213](#)

You can display information about the projector and version by viewing the **Info** menu. However, you cannot change any settings in the menu.

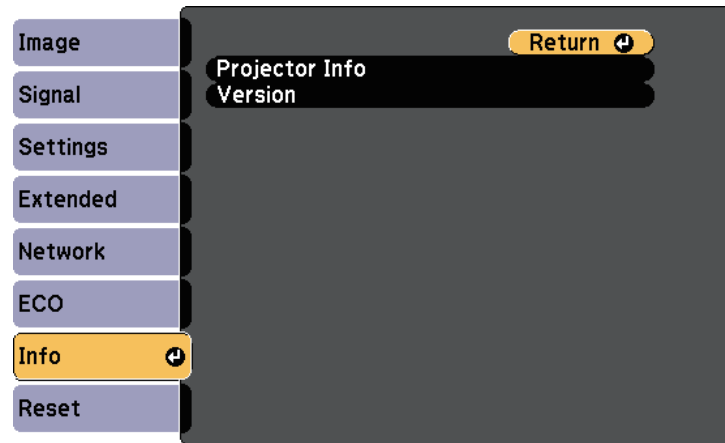

Information item	Description
Projector Info	Displays the projector information.
Version	Displays the projector's firmware version.

» **Related Links**

- "Info Menu - Projector Info Menu" [p.235](#)

Info Menu - Projector Info Menu

You can display information about the projector and input sources by viewing the **Projector Info** menu in the projector's **Info** menu.

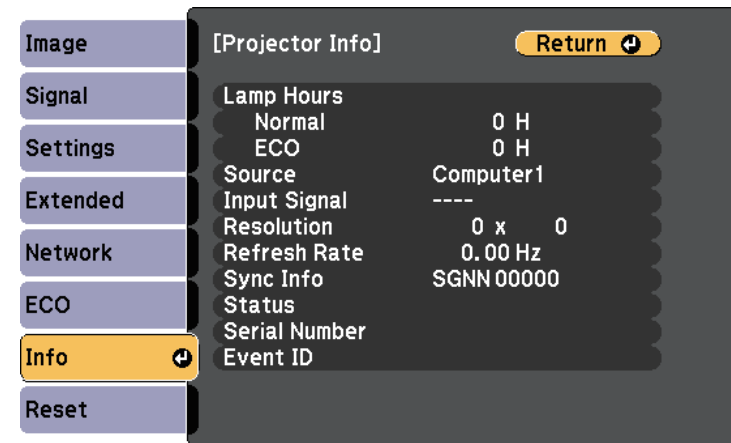

 The available settings depend on the current input source. The lamp usage timer does not register any hours until you have used the lamp for at least 10 hours.

Information item	Description
Lamp Hours	Displays the number of hours (H) the lamp has been used in Normal and ECO Power Consumption modes; if the information is displayed in yellow, obtain a genuine Epson replacement lamp soon.
Source	Displays the name of the port to which the current input source is connected.
Input Signal	Displays the input signal setting of the current input source.
Resolution	Displays the resolution of the current input source.

Information item	Description
Video Signal	Displays the video signal format of the current input source.
Refresh Rate	Displays the refresh rate of the current input source.
Sync Info	Displays information that may be needed by a service technician.
Status	Displays information about projector problems that may be needed by a service technician.
Serial Number	Displays the projector's serial number.
Event ID	Displays the Event ID number corresponding to a network problem; see the list of Event ID codes.

» **Related Links**

- "Event ID Code List" [p.236](#)

Event ID Code List

If the **Event ID** option on the **Info** menu displays a code number, check this list of Event ID codes for the solution to the projector problem associated with the code.

If you cannot resolve the problem, contact your network administrator or Epson for technical support.

Event ID code	Cause and solution
0432 0435	The network software did not start. Turn the projector off and then on again.
0433	Cannot display the transferred images. Restart the network software.
0434 0481 0482 0485	Unstable network communication. Check the network communication status, wait a few moments, and try connecting to the network again.
0483 04FE	The network software quit unexpectedly. Check the network communication status, then turn the projector off and then on again.

Event ID code	Cause and solution
0484	Communication with computer was disconnected. Restart the network software.
0479 04FF	A projector system error has occurred. Turn the projector off and then on again.
0891	Cannot find an access point with the same SSID. Set your computer, access point, and projector to the same SSID.
0892	The WPA/WPA2 authentication type does not match. Make sure the wireless network security settings are correct.
0893	The TKIP/AES encryption type does not match. Make sure the wireless network security settings are correct.
0894	Communication with an unauthorized access point was disconnected. Contact your network administrator.
0898	Failed to acquire DHCP. Make sure the DHCP server is operating correctly. If you are not using DHCP, set the DHCP setting to Off in the projector's Network menu.  Network > Network Configuration > Wireless LAN > IP Settings > DHCP
0899	Other communication errors.
089A	The EAP authentication type does not match the network. Check the wireless LAN security settings and make sure that the security certificate is installed correctly.
089B	EAP server authentication failed. Check the wireless LAN security settings and make sure that the security certificate is installed correctly.
089C	EAP client authentication failed. Check the wireless LAN security settings and make sure that the security certificate is installed correctly.
089D	Key exchange failed. Check the wireless LAN security settings and make sure that the security certificate is installed correctly.

Event ID code	Cause and solution
0B01	The internal storage could not be detected correctly. Turn off the projector and disconnect the power cord, then reconnect the power cord and turn the projector back on. The internal storage is recovered when the projector is turned on and all of the Whiteboard Settings menu items are returned to the default settings. The template information, address book, and shared whiteboard connection logs saved in the internal storage are deleted. If that does not solve the problem, contact Epson for help.
0BFF	An error has occurred in the whiteboard function. Restart the projector.

You can reset most of the projector settings to their default values using the **Reset All** option on the **Reset** menu.

You can also reset the projector's lamp usage timer to zero when you replace the lamp using the **Reset Lamp Hours** option.

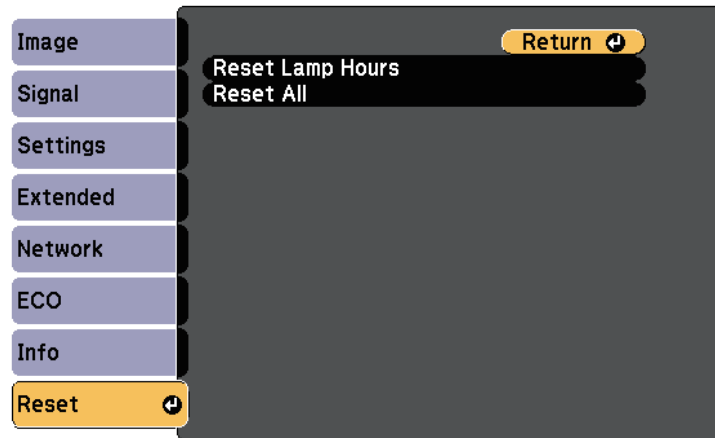

You cannot reset the following settings using the **Reset All** option:

- Input Signal
- Zoom
- Image Shift
- User's Logo
- Color Uniformity
- Color Matching
- Schedule Settings
- Language
- Date & Time
- Network menu items
- Lamp Hours
- Password

After selecting the projector's menu settings for one projector, you can use the following methods to copy the settings to other projectors, as long as they are the same model.

- by using a USB flash drive
- by using EasyMP Network Updater

Menu settings such as the following are not copied to the other projector.

- **Network** menu settings (except for the **Notifications** menu and the **Others** menu)
- **Lamp Hours** and **Status** from the **Info** menu



Perform batch setup before adjusting the image settings such as Keystone. Since image adjustment values are also copied to another projector, the adjustments you made before performing the batch setup are overwritten and the projected screen you adjusted may change.

When copying the menu settings from one projector to another, user's logo is also copied. Do not register the information that you do not want to share between multiple projectors as a user's logo.

Caution

Epson takes no responsibility for batch setup failures and associated repair costs due to power outages, communication errors, or other problems that may cause such failures.

» Related Links

- "Transferring Settings From a USB Flash Drive" [p.239](#)

Transferring Settings From a USB Flash Drive

You can copy menu settings from one projector to another of the same model using a USB flash drive.



The USB flash drive must use a FAT format and not incorporate any security function. Delete any files on the drive before using it for batch setup or the settings may not be saved correctly.

- 1** Disconnect the power cord from the projector, and check that all of the projector's indicators have turned off.
- 2** Connect an empty USB flash drive directly to the projector's USB-A port.
- 3** Hold down the [Esc] button on the remote control or the control panel and connect the power cord to the projector.
- 4** When all of the projector's indicators turn on, release the [Esc] button. The indicators start flashing and the batch setup file is written to the USB flash drive. When writing is finished, the projector turns off.

Caution

Do not disconnect the power cord or the USB flash drive from the projector while the file is being written. If the power cord or USB flash drive is disconnected, the projector may not start correctly.

- 5** Remove the USB flash drive.



The file name for the batch setup file is PJCONFDATA.bin. If you need to change the file name, add text after PJCONFDATA using only alphanumeric characters. If you change the PJCONFDATA section of the file name, the projector may not be able to recognize the file correctly.

- 6** Disconnect the power cord from the projector to which you want to copy settings, and check that all of the projector's indicators have turned off.

7 Connect the USB flash drive containing the saved batch setup file to the projector's USB-A port.

8 Hold down the [Menu] button on the remote control or the control panel and connect the power cord to the projector.

9 When all of the projector's indicators turn on, release the [Menu] button. (The indicators remain on for approximately 75 seconds.)

When all of the indicators start flashing, the settings are being written.
When writing is finished, the projector turns off.

⚠ Caution

Do not disconnect the power cord or the USB flash drive from the projector while the file is being written. If the power cord or drive is disconnected, the projector may not start correctly.

10 Remove the USB flash drive.

» **Related Links**

- "Batch Setup Error Notification" [p.240](#)

Batch Setup Error Notification

The projector's indicators notify you if an error occurs during a batch setup operation. Check the status of the projector's indicators and follow the instructions described in the table here.

Indicator status	Problem and solution
<p>On/Standby Status Lamp Temp</p> <ul style="list-style-type: none"> • Power: Blue - flashing fast • Status: Blue - flashing fast • Lamp: Orange - flashing fast • Temp: Orange - flashing fast 	<p>Writing the settings may have failed and an error may have occurred in the projector's firmware.</p> <p>Stop using the projector, remove the power plug from the electrical outlet. Contact Epson for help.</p>

Indicator status	Problem and solution
<p>On/Standby Status Lamp Temp</p> <ul style="list-style-type: none"> • Lamp: Orange - flashing fast • Temp: Orange - flashing fast 	<p>The batch setup file may be corrupt, or the USB flash drive may not be connected correctly.</p> <p>Disconnect the USB flash drive, unplug and then plug in the projector's power cord, and then try again.</p>

Maintaining the Projector

You may need to clean the projection window and obstacle sensor periodically, and clean the air filter and air vents to prevent the projector from overheating due to blocked ventilation.

The only parts you should replace are the lamp, air filter, remote control batteries, interactive pen batteries, and interactive pen tips. If any other part needs replacing, contact Epson or an authorized Epson servicer.

Warning

Before cleaning any part of the projector, turn it off and unplug the power cord. Never open any cover on the projector, except as specifically explained in this manual. Dangerous electrical voltages in the projector can injure you severely.

» Related Links

- "Cleaning the Projection Window" [p.242](#)
- "Cleaning the Obstacle Sensor" [p.243](#)
- "Cleaning the Projector Case" [p.244](#)
- "Air Filter and Vent Maintenance" [p.245](#)
- "Projector Lamp Maintenance" [p.249](#)
- "Replacing the Remote Control Batteries" [p.254](#)
- "Replacing the Interactive Pen Battery" [p.255](#)
- "Replacing the Interactive Pen Tip" [p.256](#)

Clean the projection window periodically, or whenever you notice dust or smudges on the surface. To remove dust or smudges, gently wipe the projection window with lens-cleaning paper.

 **Warning**

Do not use a lens cleaner that contains flammable gas. The high heat generated by the projector lamp may cause a fire.

Attention

Do not use glass cleaner or any harsh materials to clean the projection window and do not subject the projection window to any impacts; otherwise, it could be damaged.

Clean the projector's obstacle sensor glass periodically, or if you see a message telling you to remove any obstacles that are interfering with the projection area. To remove dust or smudges, gently wipe the lens with lens-cleaning paper.

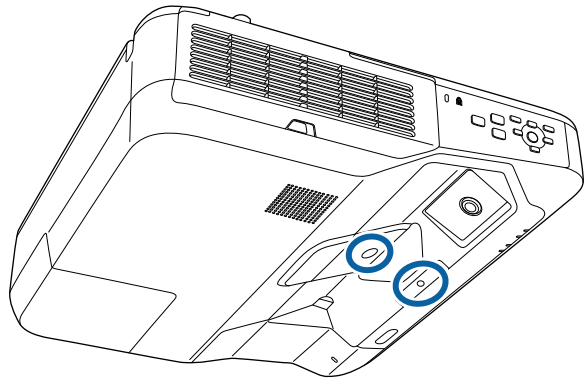

Warning

Do not use a lens cleaner that contains flammable gas to clean the obstacle sensor. The high heat generated by the projector lamp may cause a fire.

Attention

Do not use glass cleaner or any harsh materials to clean the obstacle sensor and do not subject the obstacle sensor to any impacts. Damage on the surface of the sensor may cause malfunctions.

Before cleaning the projector case, turn off the projector and unplug the power cord.

- To remove dust or dirt, use a soft, dry, lint-free cloth.
- To remove stubborn dirt, use a soft cloth moistened with water and mild soap. Do not spray liquid directly on the projector.

Attention

Do not use wax, alcohol, benzene, paint thinner, or other chemicals to clean the projector case. These can damage the case. Do not use canned air, or the gases may leave a flammable residue.

Regular filter maintenance is important to maintaining your projector. Clean the air filter when a message appears telling you the temperature inside the projector has reached a high level. It is recommended that you clean these parts at least once every three months. Clean them more often than this if you use the projector in a particularly dusty environment.

Attention

If regular maintenance is not performed, your Epson projector will notify you when the temperature inside the projector has reached a high level. Do not wait until this warning appears to maintain your projector filter as prolonged exposure to high temperatures may reduce the life of your projector or lamp.

► Related Links

- "Cleaning the Air Filter" [p.245](#)
- "Replacing the Air Filter" [p.247](#)

Cleaning the Air Filter

Clean the projector's air filter if it gets dusty, or if you see a message telling you to clean it.

- 1** Turn off the projector and unplug the power cord.

- 2** Slide the air filter cover latch and open the air filter cover.

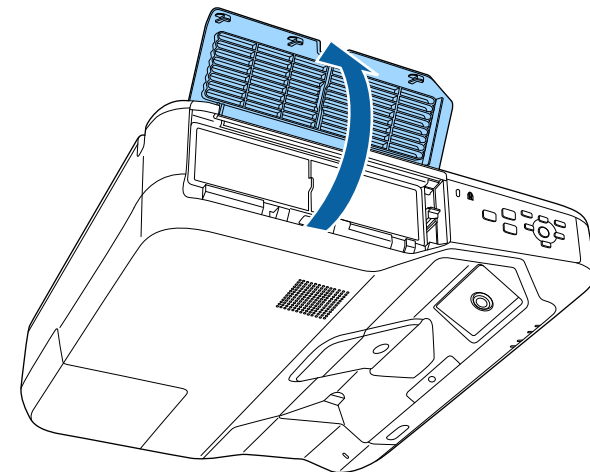
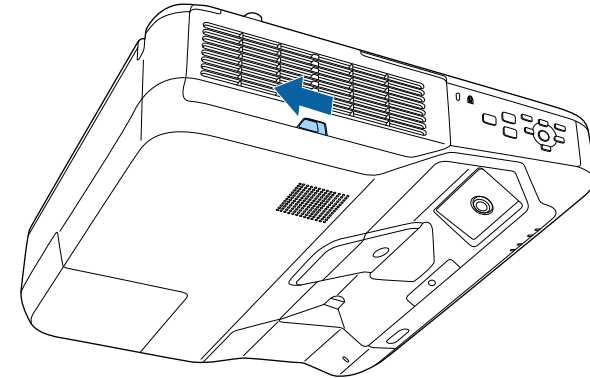

- 3** Pull the air filter out of the projector.

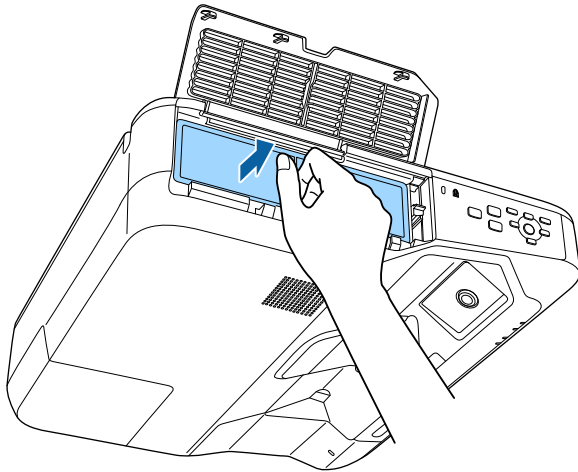

Attention

Do not use excessive force when tapping the air filter, or it may crack and become unusable.

- 5** Vacuum the front of the air filter (the side with the tabs) to remove any remaining dust.

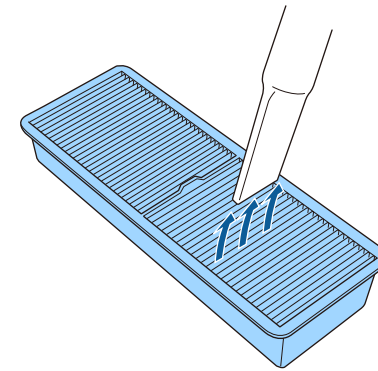

- 4** Tap each side of the air filter 4 to 5 times to shake off any excess dust.

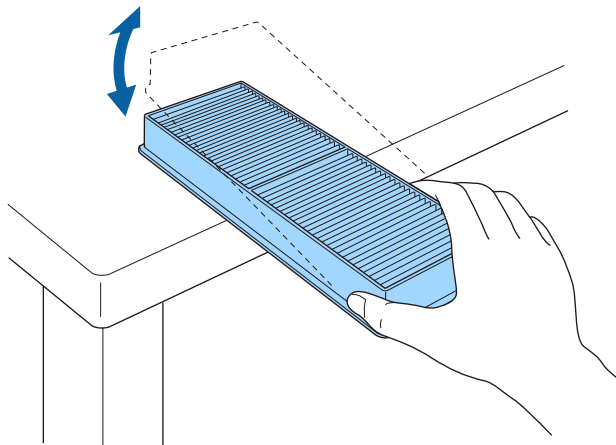

Attention

- Do not rinse the air filter in water, or use any detergent or solvent to clean it.
- Do not use canned air. The gases may leave a flammable residue or push dust and debris into the projector's optics or other sensitive areas.

- 6 Replace the air filter in the projector as shown and push gently until it clicks into place.

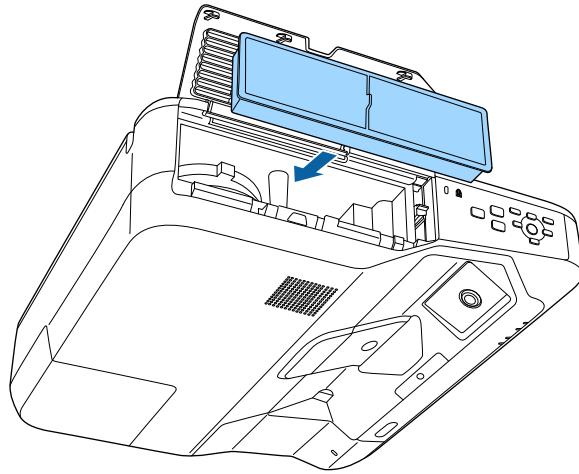

- 7 Close the air filter cover.

Replacing the Air Filter

You need to replace the air filter in the following situations:

- After cleaning the air filter, you see a message telling you to clean or replace it
- The air filter is torn or damaged

You can replace the air filter while the projector is mounted to the ceiling or placed on a table.

- 1 Turn off the projector and unplug the power cord.

- 2 Slide the air filter cover latch and open the air filter cover.

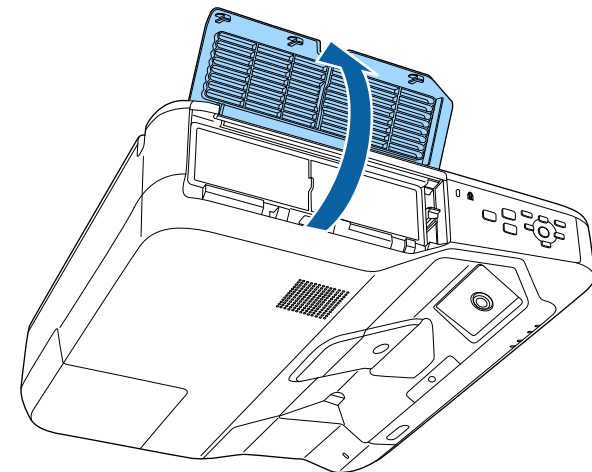
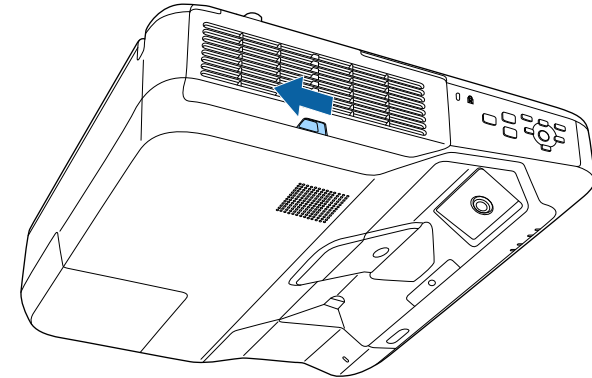

3 Pull the air filter out of the projector.

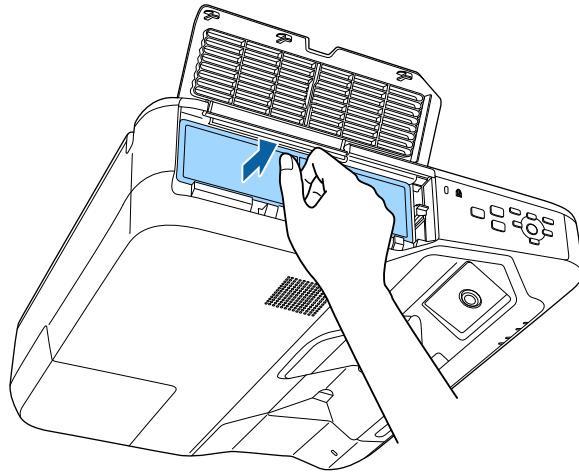

4 Place the new air filter in the projector as shown and push gently until it clicks into place.

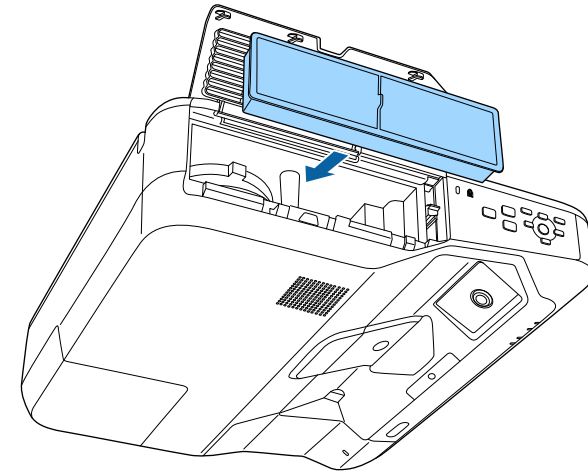

Dispose of used air filters according to local regulations.

- Filter frame: Polypropylene
- Filter: Polypropylene

5 Close the air filter cover.

» **Related Links**

- "Replacement Parts" [p.279](#)

The projector monitors the number of hours the lamp is used and displays this information in the projector's menu system.

Replace the lamp as soon as possible when the following occurs:

- The projected image gets darker or quality declines
- A message is displayed when you turn on the projector telling you to replace the lamp (the message is displayed 100 hours before the expected end of the lamp life and appears for 30 seconds)



- The projector's power indicator is flashing blue and its lamp indicator is flashing orange.

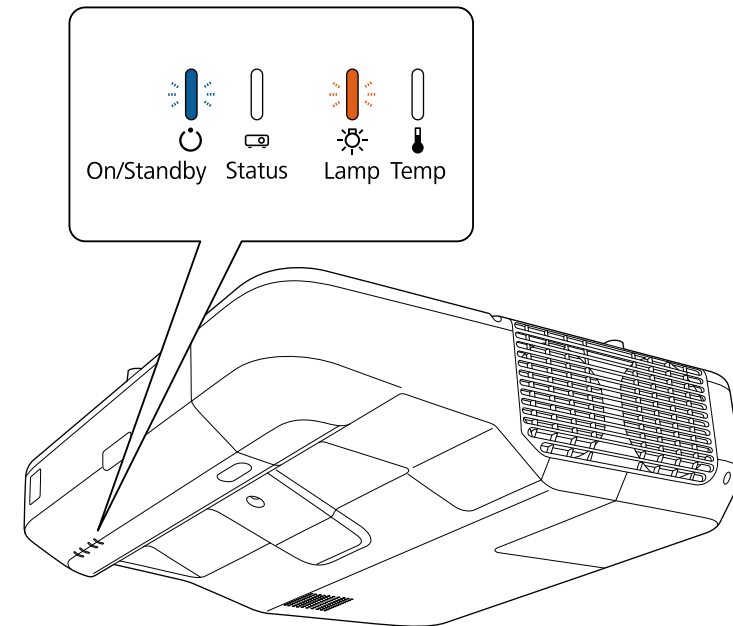

Attention

- If you continue to use the lamp after the replacement period has passed, the possibility that the lamp may explode increases. When the lamp replacement message appears, replace the lamp with a new one as soon as possible, even if it is still working.
- Do not repeatedly turn off the power and then immediately turn it back on. Turning the power on and off frequently may shorten the lamp's operating life.
- Depending on the characteristics of the lamp and the way it has been used, the lamp may become darker or stop working before the lamp warning message appears. You should always have a spare lamp unit ready in case it is needed.
- We recommend the use of genuine Epson replacement lamps. The use of non-genuine lamps may affect projection quality and safety. Any damage or malfunction caused by the use of non-genuine lamps may not be covered by Epson's warranty.

» Related Links

- "Replacing the Lamp" [p.250](#)
- "Resetting the Lamp Timer" [p.252](#)
- "Projector Specifications" [p.283](#)

Replacing the Lamp

You can replace the lamp while the projector is placed on a table or mounted to the ceiling.

Warning

- Let the lamp fully cool before replacing it to avoid injury.
- Never disassemble or modify the lamp. If a modified or disassembled lamp is installed in the projector, it could cause a fire, electric shock, or other damage or injury.

- 1** Turn off the projector and unplug the power cord.
- 2** Allow the projector lamp to cool down for at least one hour.
- 3** Use the screwdriver included with the replacement lamp to loosen the screw securing the lamp cover.

Warning

When replacing the lamp, there is a possibility that the lamp may be broken. If replacing the lamp of a projector which has been installed on the wall or ceiling, you should always assume that the lamp is cracked, and you should stand to the side of the lamp cover, not underneath it. Remove the lamp cover gently. Be careful when removing the lamp cover as shards of glass may fall out and could cause an injury. If any shards of glass get into your eyes or mouth, contact a doctor immediately.

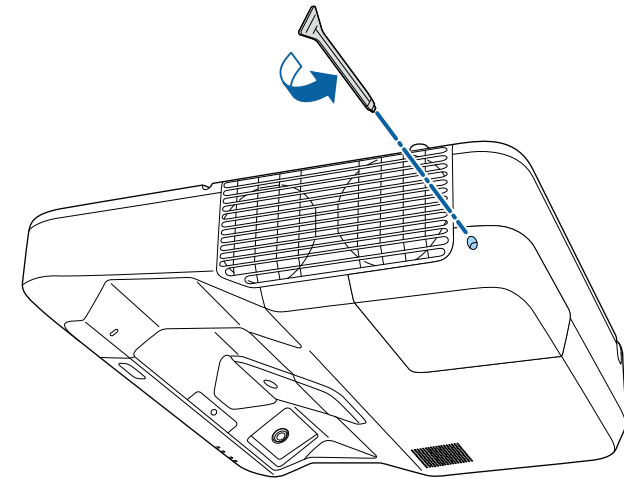

- 4** Slide off the lamp cover.

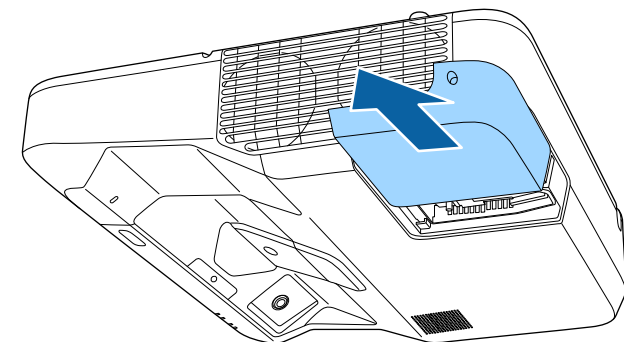



When the projector is suspended from a wall or ceiling and you need to replace the lamp, remove the lamp cover carefully and support it with your hand to prevent it from falling.

- 5** Loosen the screws securing the lamp to the projector. The screws do not come all the way out.

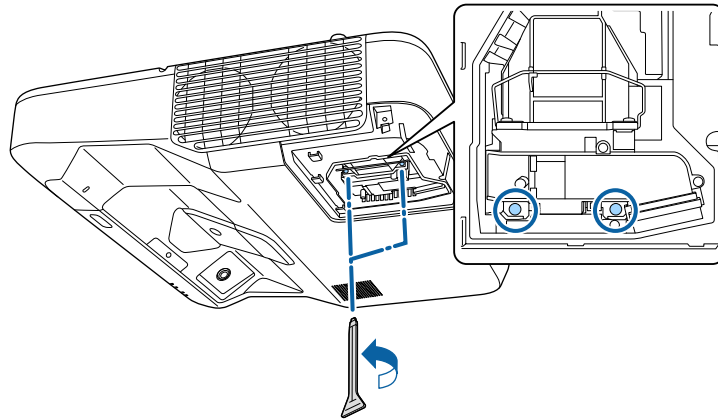

- 6** Grip the lamp handle and carefully pull the lamp out of the projector.

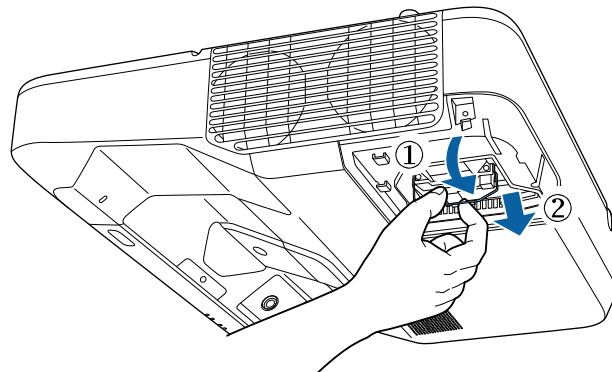

- If you notice the lamp is cracked when removing the lamp, replace it with a new lamp, or contact Epson for help.
- The lamp(s) in this product contain mercury (Hg). Check your local laws and regulations regarding disposal or recycling. Do not put in the trash.

- 7** Gently insert the new lamp into the projector. If it does not fit easily, make sure it is facing the right way. Press the handle up.

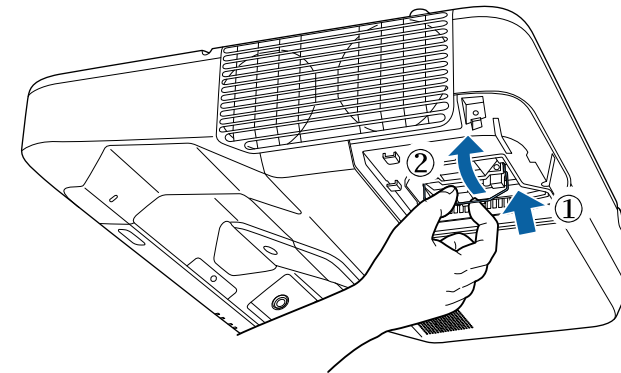

Attention

Do not touch any glass on the lamp assembly to avoid premature lamp failure.

- 8** Push in the lamp firmly and tighten the screws to secure it.

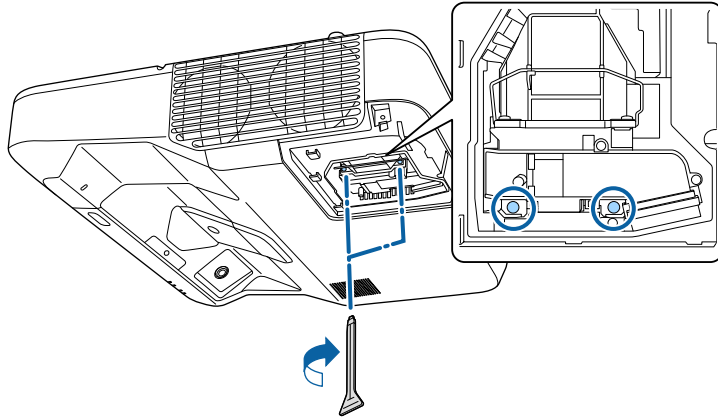

- 9** Replace the lamp cover and tighten the screw to secure it.

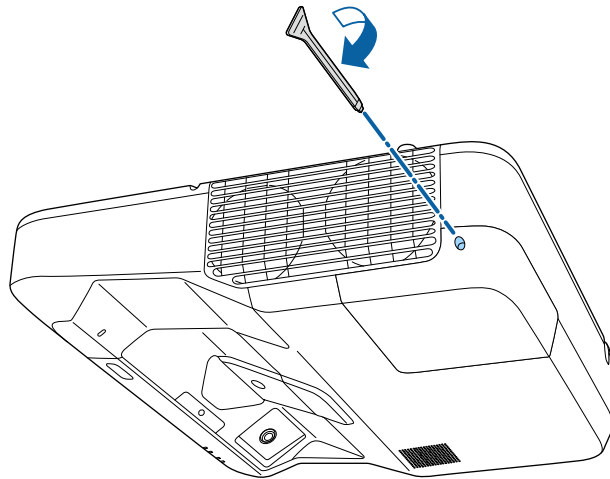

- Make sure the lamp cover is securely installed or the projector will not turn on.
- Do not replace the lamp cover with too much force and make sure the lamp cover is not deformed.

Reset the lamp timer to zero to monitor the new lamp's usage.

► Related Links

- "Replacement Parts" [p.279](#)

Resetting the Lamp Timer

You must reset the lamp timer after replacing the projector's lamp to clear the lamp replacement message and to monitor lamp usage correctly.



Do not reset the lamp timer if you have not replaced the lamp to avoid inaccurate lamp usage information.

- 1** Turn on the projector.
- 2** Press the [Menu] button on the control panel or remote control.
- 3** Select the **Reset** menu and press [Enter].

- 4 Select **Reset Lamp Hours** and press [Enter].

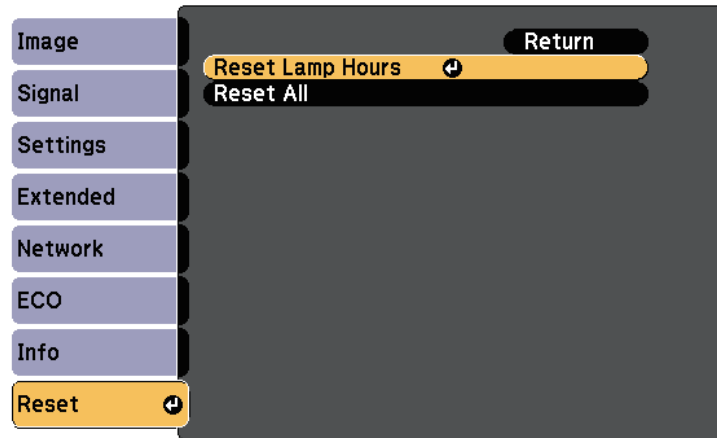

You see a prompt asking if you want to reset the lamp hours.

- 5 Select **Yes** and press [Enter].
- 6 Press [Menu] or [Esc] to exit the menus.

The remote control uses two AA manganese or alkaline batteries. Replace the batteries as soon as they run out.

Attention

Make sure you read the *Safety Instructions* before handling the batteries.

- 1 Remove the battery cover as shown.

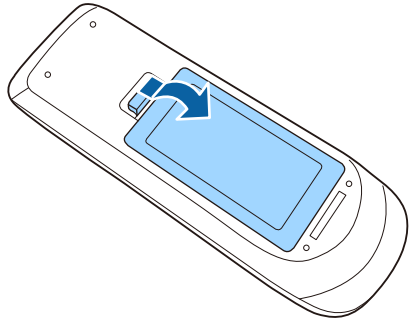

- 2 Remove the old batteries.

- 3 Insert the batteries with the + and - ends facing as shown.

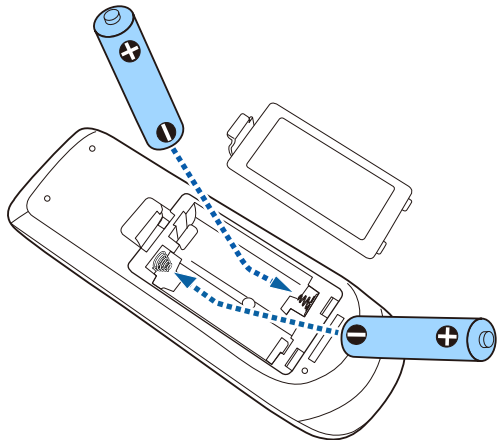

Warning

Check the positions of the (+) and (-) marks inside the battery holder to ensure the batteries are inserted the correct way. If the batteries are not used correctly, they could explode or leak causing a fire, injury, or damage to the product.

- 4 Replace the battery cover and press it down until it clicks into place.

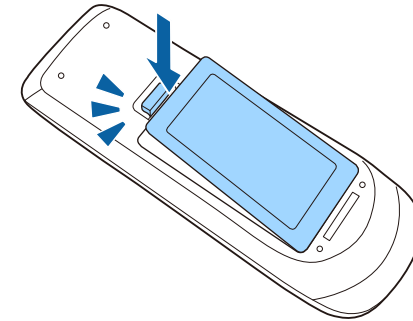

The Interactive pen uses one AA manganese battery, AA alkaline battery, or Enloop (BK-3MCC) rechargeable battery. Replace the battery as soon as it runs out.

When the battery is low, the pen indicator flashes when you press the button on the side of the pen. When the battery runs out, the pen indicator turns off.

Attention

Make sure you read the *Safety Instructions* before handling the batteries.

- 1 Remove the battery cover as shown.

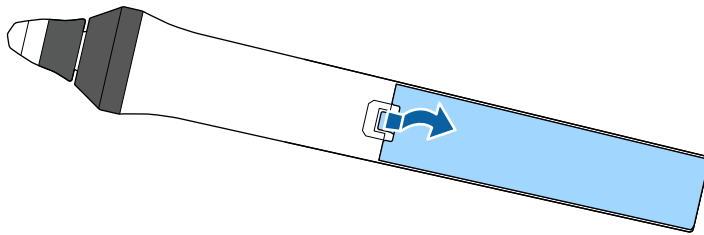

- 2 Remove the old battery.

- 3 Insert the battery with the + and - ends facing in the correct direction as shown.

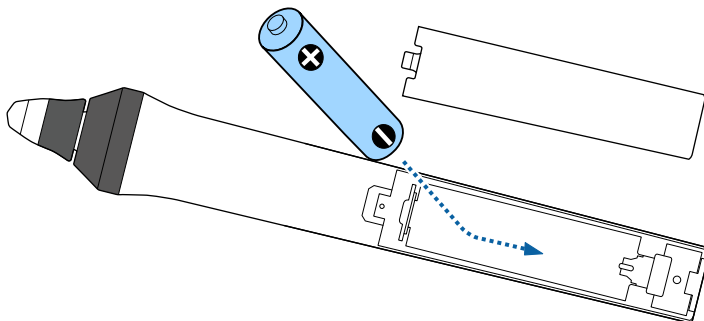

Warning

Check the positions of the (+) and (-) marks inside the battery holder to ensure the battery is inserted in the correct direction. If the battery is not used correctly, it could explode or leak causing a fire, injury, or damage to the product.

- 4 Replace the battery cover and press it down until it clicks into place.

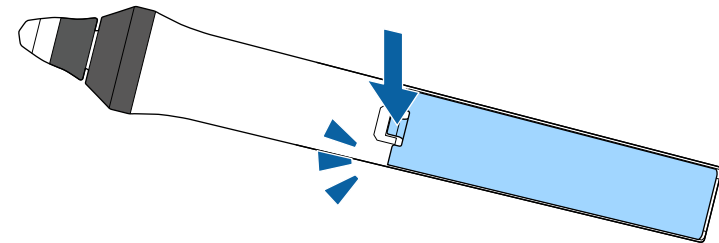

Two interactive pens come with two types of pen tips, soft tips and hard tips. The soft pen tips are installed on the pens by default.

- If the soft tip gets dirty or damaged, it becomes less responsive. Replace it with a new one supplied with the product.
- If the soft tip is hard to use on a textured surface, replace it with the hard tip.



If the hard tip is worn down or damaged, replace it with a new one.

» Related Links

- "Replacing the Soft Pen Tip" [p.256](#)
- "Replacing the Soft Pen Tip with the Hard Pen Tip" [p.257](#)

Replacing the Soft Pen Tip

- 1** Twist off the tip of the interactive pen to remove it.

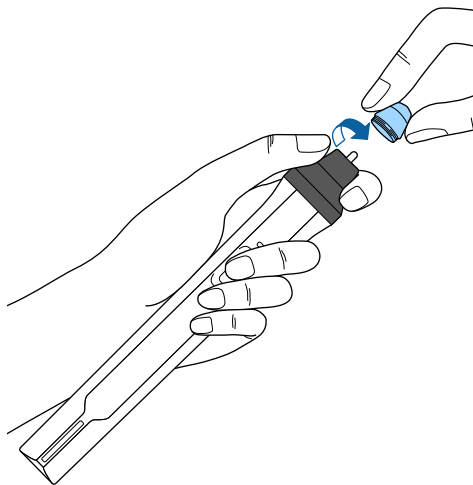

- 2** Pull the soft tip straight out.

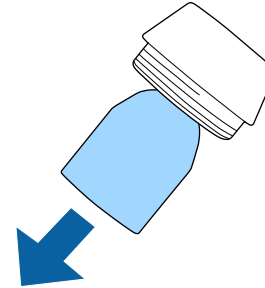

- 3** Insert the new tip.

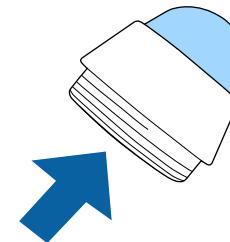

- 4** Twist on the pen tip.

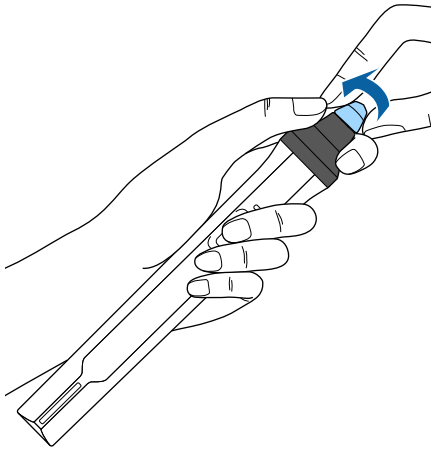

2 Twist on the hard pen tip.

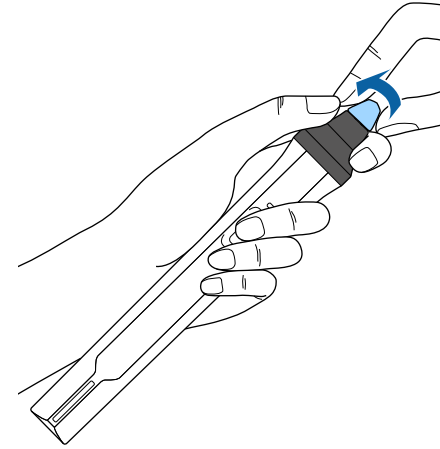

Replacing the Soft Pen Tip with the Hard Pen Tip

1 Twist off the tip of the interactive pen to remove it.

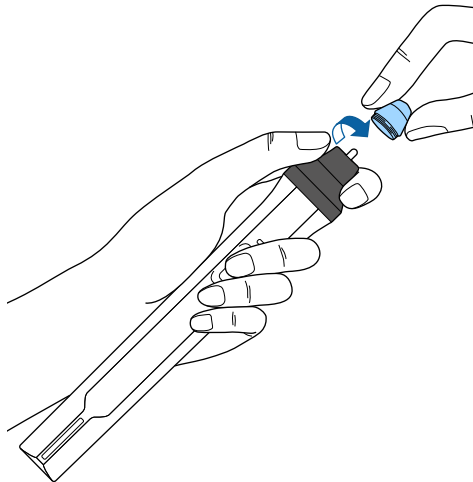

Solving Problems

Check the solutions in these sections if you have any problems using the projector.

► Related Links

- "Projection Problems" [p.259](#)
- "Projector Indicator Status" [p.260](#)
- "Using the Projector Help Displays" [p.262](#)
- "Solving Image or Sound Problems" [p.263](#)
- "Solving Projector or Remote Control Operation Problems" [p.269](#)
- "Solving Interactive Features Problems" [p.271](#)
- "Solving Network Problems" [p.275](#)

If the projector is not working properly, turn it off, unplug it, and then plug it back in and turn it on.

If this does not solve the problem, check the following:

- The indicators on the projector may indicate the problem.
- The projector's Help system can display information about common problems.
- The solutions in this manual can help you solve many problems.

If none of these solutions help, contact Epson for technical support.

The indicators on the projector indicate the projector status and let you know when a problem occurs. Check the status and color of the indicators and then refer to this table for a solution.

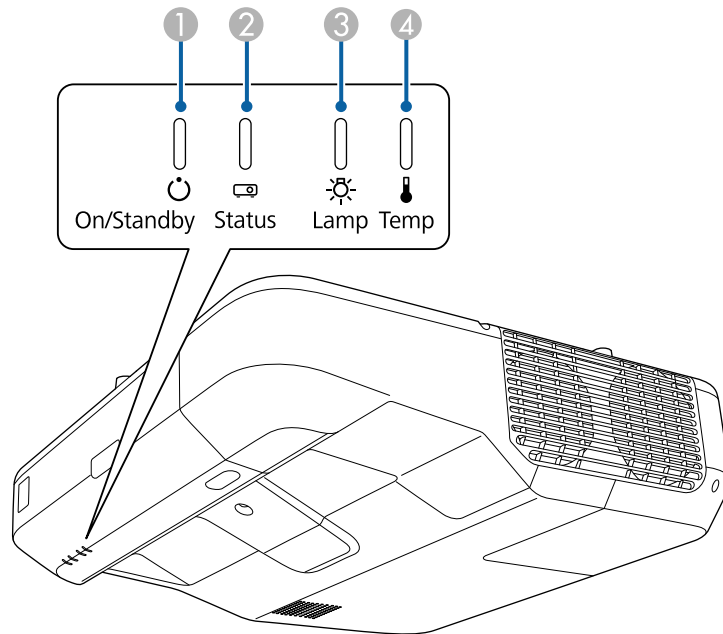

 If the indicators display a pattern not listed in the table below, turn the projector off, unplug it, and contact Epson for help.



- ① Power indicator
- ② Status indicator
- ③ Lamp indicator
- ④ Temp (temperature) indicator

Projector status

Indicator and status	Problem and solutions
Power: Lit blue Status: Lit blue Lamp: Off Temp: Off	Normal operation.
Power: Lit blue Status: Flashing blue Lamp: Off Temp: Off	Warming up or shutting down. When warming up, wait about 30 seconds for an image to appear. All buttons are disabled during warm-up and shutting down.
Power: Lit blue Status: Off Lamp: Off Temp: Off	Standby, sleep mode, or monitoring. When you press the power button, projection starts.
Power: Flashing blue Status: Off Lamp: Off Temp: Off	Preparing for monitoring and all features are disabled.
Power: Flashing blue Status: Indicator status varies Lamp: Indicator status varies Temp: Flashing orange	Projector is too hot. <ul style="list-style-type: none"> • Make sure that the vents and air filter are not clogged with dust or obstructed by nearby objects. • Clean or replace the air filter. • Make sure the environmental temperature is not too hot.

Indicator and status	Problem and solutions
Power: Off Status: Flashing blue Lamp: Off Temp: Lit orange	<p>Projector has overheated and turned off. Leave it turned off to cool down for 5 minutes.</p> <ul style="list-style-type: none"> • Make sure that the vents and air filter are not clogged with dust or obstructed by nearby objects. • Clean or replace the air filter. • If operating the projector at high altitude, set the High Altitude Mode setting to On in the projector's Extended menu.  Extended > Operation > High Altitude Mode • If the problem persists, unplug the projector and contact Epson for help.
Power: Off Status: Flashing blue Lamp: Lit orange Temp: Off	<p>Lamp has a problem.</p> <ul style="list-style-type: none"> • Check to see if the lamp is burned out, broken, or installed incorrectly. Reseat or replace the lamp as necessary. • Clean the air filter. • If operating the projector at high altitude, set the High Altitude Mode setting to On in the projector's Extended menu.  Extended > Operation > High Altitude Mode • If the problem persists, unplug the projector and contact Epson for help.
Power: Flashing blue Status: Indicator status varies Lamp: Flashing orange Temp: Indicator status varies	<p>Replace the lamp soon to avoid damage. Do not continue using the projector.</p>
Power: Off Status: Flashing blue Lamp: Off Temp: Flashing orange	<p>A fan or sensor has a problem. Turn the projector off, unplug it, and contact Epson for help.</p>

Indicator and status	Problem and solutions
Power: Off Status: Flashing blue Lamp: Flashing orange Temp: Off	<p>Internal projector error. Turn the projector off, unplug it, and contact Epson for help.</p>
Power: Off Status: Flashing blue Lamp: Flashing orange Temp: Flashing orange	<p>Auto iris error. Turn the projector off, unplug it, and contact Epson for help.</p>
Power: Off Status: Flashing blue Lamp: Lit orange Temp: Lit orange	<p>Power error (Ballast). Turn the projector off, unplug it, and contact Epson for help.</p>
Power: Off Status: Flashing blue Lamp: Lit orange Temp: Lit orange	<p>Obstacle detection error. A beep sounds, and the message "For safety purposes remove any obstacles blocking the lens." is displayed. The projector turns off automatically if no action is taken.</p> <ul style="list-style-type: none"> • Make sure that there are no obstacles interfering with the projection window. Remove any obstacles. • Clean the obstacle sensor if there are no obstacles. <p>If the problem persists, turn the projector off, unplug it, and contact Epson for help.</p>

» **Related Links**

- "Cleaning the Air Filter" [p.245](#)
- "Replacing the Air Filter" [p.247](#)
- "Replacing the Lamp" [p.250](#)

You can display information to help you solve common problems using the projector's Help system.

- 1 Turn on the projector.
- 2 Press the [Home] button on the control panel or remote control.

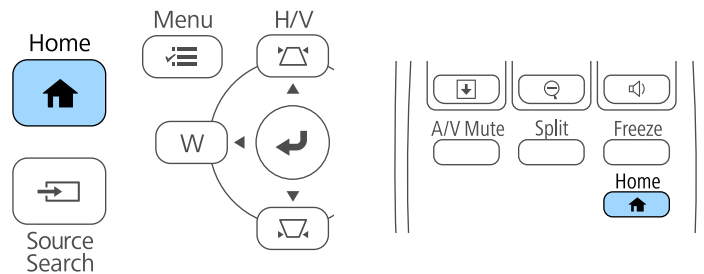

- 3 Select the  icon on the Home screen.



- 4 Select **Display the Help** menu on the displayed message.

The Help menu is displayed.

- 5 Use the up and down arrow buttons to highlight the problem you want to solve.

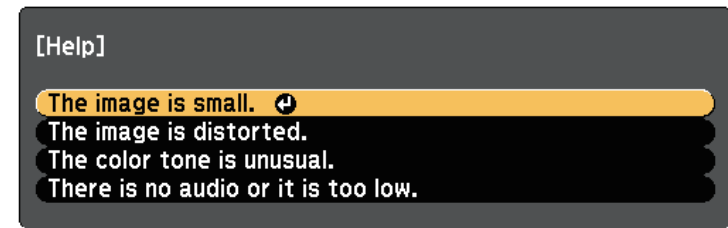

- 6 Press [Enter] to view the solutions.
- 7 Perform one of the following actions when you are finished.
 - To select another problem to solve, press [Esc].
 - To exit the help system, press [Menu].

Check the solutions in these sections if you have any problems with projected images or sound.

► Related Links

- "Solutions When No Image Appears" [p.263](#)
- "Solutions When Image is Incorrect Using the USB Display Function" [p.263](#)
- "Solutions When "No Signal" Message Appears" [p.264](#)
- "Solutions When "Not Supported" Message Appears" [p.265](#)
- "Solutions When Only a Partial Image Appears" [p.265](#)
- "Solutions When the Image is not Rectangular" [p.265](#)
- "Solutions When the Image Contains Noise or Static" [p.266](#)
- "Solutions When the Image is Fuzzy or Blurry" [p.266](#)
- "Solutions When the Image Brightness or Colors are Incorrect" [p.267](#)
- "Solutions to Sound Problems" [p.267](#)
- "Solutions When Image File Names are not Displayed Correctly in PC Free" [p.268](#)

Solutions When No Image Appears

If no image appears, try the following solutions:

- Press the power button to turn the power on.
- Press the [A/V Mute] button on the remote control to see if the image was temporarily turned off.
- Make sure all necessary cables are securely connected and the power is on for the projector and connected video sources.
- Make sure the image being projected is not completely black (only when projecting computer images).
- Make sure the projector's menu settings are correct.
- Press the projector's power button to wake it from standby or sleep mode. Also, check if the connected computer is in sleep mode or displaying a blank screen saver.
- Check the settings on the projector's **Signal** menu to make sure they are correct for the current video source.
- Adjust the **Brightness** setting in the projector's **Image** menu.

- Select **Normal** as the **Power Consumption** setting.
 - ☛ **ECO > Power Consumption**
- Check the **Display** setting in the projector's **Extended** menu to make sure **Messages** is set to **On**.
- If the projector does not respond when you press the control panel buttons, the buttons may be locked for security. Unlock the buttons in the **Control Panel Lock** setting in the projector's **Settings** menu or use the remote control to turn on the projector.
 - ☛ **Settings > Lock Setting > Control Panel Lock**
- If the projector does not respond when you press buttons on the remote control, make sure the remote receivers are turned on.
- For images projected with Windows Media Center, reduce the screen size from full screen mode.
- For images projected from applications using Windows DirectX, turn off DirectX functions.
- The projector may not be able to project copyrighted videos that you play back on a computer. For more details, see the manual supplied with the computer.

► Related Links

- "Input Signal Settings - Signal Menu" [p.208](#)
- "Image Quality Settings - Image Menu" [p.206](#)
- "Projector Setup Settings - ECO Menu" [p.233](#)
- "Projector Setup Settings - Extended Menu" [p.213](#)
- "Unlocking the Projector's Buttons" [p.170](#)

Solutions When Image is Incorrect Using the USB Display Function

If no image appears or if the image appears incorrectly using the USB Display function, try the following solutions:

- Press the [Source Search] button on the control pad, remote control, or control panel and select USB Display.

- Make sure the Epson USB Display software has been installed correctly. Install it manually if necessary.
- For OS X, select the **USB Display** icon in the **Dock** folder. If the icon does not appear on the **Dock**, double-click **USB Display** in the **Applications** folder.
If you select **Exit** from the **USB Display** icon menu on the **Dock**, USB Display does not start automatically when you connect the USB cable.
- For images projected with Windows Media Center, reduce the screen size from full screen mode.
- For images projected from applications using Windows DirectX, turn off DirectX functions.
- If the mouse cursor flickers, select **Make the movement of the mouse pointer smooth** in the **Epson USB Display Settings** program on your computer.
- Turn off the **Transfer layered window** setting in the **Epson USB Display Settings** program on your computer.
- For projectors with a resolution of WUXGA (1920 × 1200), if you change the computer resolution during projection, the performance and quality of the video may decline.
- Select **USB Display/Easy Interactive Function** or **Wireless Mouse/USB Display** as the **USB Type B** setting in the projector's **Extended** menu.

» Related Links

- "Connecting to a Computer for USB Video and Audio" [p.29](#)

Solutions When "No Signal" Message Appears

If the "No Signal" message appears, try the following solutions:

- Press the [Source Search] button and wait a few seconds for an image to appear.
- Turn on the connected computer or video source, and press play to begin your presentation, if necessary.
- Check that all cables required for projection are securely connected.

- Connect the video source directly to the projector.
- If you are projecting from a laptop computer, make sure it is set up to display on an external monitor.
- Make sure the connected computer is not in sleep mode.
- If necessary, turn off the projector and the connected computer or video source, and then turn them back on.
- If you are projecting from an HDMI source, replace the HDMI cable with the shorter one.

» Related Links

- "Displaying From a Laptop" [p.264](#)
- "Displaying From a Mac Laptop" [p.265](#)

Displaying From a Laptop

If the message "No Signal" is displayed when projecting from a laptop, you need to set up the laptop to display on an external monitor.

- 1** Hold down the laptop's **Fn** key and press the key labeled with a monitor icon or **CRT/LCD**. (See your laptop manual for details.) Wait a few seconds for an image to appear.
- 2** To display on the laptop's monitor and the projector, try pressing the same keys again.
- 3** If the same image is not displayed by the laptop and projector, check the Windows **Display** utility to make sure the external monitor port is enabled and extended desktop mode is disabled. (See your computer or Windows manual for instructions.)
- 4** If necessary, check your video card settings and set the multiple display option to **Clone** or **Mirror**.

Displaying From a Mac Laptop

If the message "No Signal" is displayed when projecting from a Mac laptop, you need to set up the laptop for mirrored display. (See your laptop manual for details.)

- 1 Open the **System Preferences** utility and select **Displays**.
- 2 Select the **Display** or **Color LCD** option, if necessary.
- 3 Click the **Arrange** or **Arrangement** tab.
- 4 Select **Mirror Displays**.

Solutions When "Not Supported" Message Appears

If the message "Not supported" is displayed, try the following solutions:

- Make sure the correct input signal is selected on the projector's **Signal** menu.
- Make sure the computer's display resolution does not exceed the projector's resolution and frequency limits. If necessary, select a different display resolution for your computer. (See your computer manual for details.)

► Related Links

- "Input Signal Settings - Signal Menu" [p.208](#)
- "Supported Monitor Display Resolutions" [p.281](#)

Solutions When Only a Partial Image Appears

If only a partial computer image appears, try the following solutions:

- Press the [Auto] button on the remote control to optimize the image signal.
- Try adjusting the image position using the **Position** setting in the projector's **Signal** menu.

- Press the [Aspect] button on the remote control to select a different image aspect ratio.
- Change the **Resolution** setting in the projector's **Signal** menu according to the signal for the connected equipment.
- If you zoomed into or out of the image using the [E-Zoom] buttons, press the [Esc] button until the projector returns to a full display.
- Check your computer display settings to disable dual display and set the resolution within the projector's limits. (See your computer manual for details.)
- Check the resolution assigned to your presentation files to see if they are created for a different resolution. (See your software help for details.)
- Make sure you selected the correct projection mode. You can select this using the **Projection** setting in the projector's **Extended** menu.
- Perform Image Shift to adjust the image position after adjusting the image size or correcting keystone distortion.

► Related Links

- "Input Signal Settings - Signal Menu" [p.208](#)
- "Projector Setup Settings - Extended Menu" [p.213](#)
- "Supported Monitor Display Resolutions" [p.281](#)
- "Adjusting the Image Position" [p.67](#)

Solutions When the Image is not Rectangular

If the projected image is not evenly rectangular, try the following solutions:

- Place the projector directly in front of the center of the screen, facing it squarely, if possible.
- If you adjusted the projector height using the projector feet, press the keystone buttons on the projector to adjust the image shape.
- Adjust the Quick Corner setting to correct the image shape.
 - ☛ **Settings > Geometry Correction > Quick Corner**
- Adjust the Arc Correction setting to correct the image shape projected on a curved surface.
 - ☛ **Settings > Geometry Correction > Arc Correction**

» Related Links

- "Correcting the Image Shape with the Keystone Buttons" [p.59](#)
- "Correcting the Image Shape with Quick Corner" [p.60](#)
- "Correcting Image Shape with Curved Surface" [p.62](#)

Solutions When the Image Contains Noise or Static

If the projected image contains electronic interference (noise) or static, try the following solutions:

- Check the cables connecting your computer or video source to the projector. They should be:
 - Separated from the power cord to prevent interference
 - Securely connected at both ends
 - Not connected to an extension cable
- Check the settings on the projector's **Signal** menu to make sure they match the video source.
- If available for your video source, adjust the **Deinterlacing** and **Noise Reduction** settings in the projector's **Image** menu.
- Select a computer video resolution and refresh rate that are compatible with the projector.
- If you are projecting from a computer, press the [Auto] button on the remote control to automatically adjust the **Tracking** and **Sync.** settings. If the images are not adjusted correctly, manually adjust the **Tracking** and **Sync.** settings in the projector's **Signal** menu.
- Select **Auto** as the **Resolution** setting in the projector's **Signal** menu.
- If you adjusted the image shape using the projector controls, try decreasing the **Sharpness** setting in the projector's **Image** menu to improve image quality.
- If you connected an extension power cable, try projecting without it to see if it caused interference in the signal.
- If you are using the USB Display function, turn off the **Transfer layered window** setting in the **Epson USB Display Settings** program on your computer.

» Related Links

- "Input Signal Settings - Signal Menu" [p.208](#)
- "Image Quality Settings - Image Menu" [p.206](#)
- "Supported Monitor Display Resolutions" [p.281](#)

Solutions When the Image is Fuzzy or Blurry

If the projected image is fuzzy or blurry, try the following solutions:

- Adjust the image focus.
- Clean the projection window.



To avoid condensation on the lens after bringing the projector in from a cold environment, let the projector warm up to room temperature before using it.

- Position the projector close enough to the screen.
- Position the projector so the keystone adjustment angle is not so wide that it distorts the image.
- Adjust the **Sharpness** setting in the projector's **Image** menu to improve image quality.
- If you are projecting from a computer, press the [Auto] button on the remote control to automatically adjust the tracking and sync. If any bands or overall blurriness remain, display a uniformly patterned image on the screen and manually adjust the **Tracking** and **Sync.** settings in the projector's **Signal** menu.
- If you are projecting from a computer, use a lower resolution or select a resolution that matches the projector's native resolution.

» Related Links

- "Input Signal Settings - Signal Menu" [p.208](#)
- "Image Quality Settings - Image Menu" [p.206](#)
- "Supported Monitor Display Resolutions" [p.281](#)
- "Cleaning the Obstacle Sensor" [p.243](#)

Solutions When the Image Brightness or Colors are Incorrect

If the projected image is too dark or light, or the colors are incorrect, try the following solutions:

- Press the [Color Mode] button on the remote control to try different color modes for the image and environment.
- Check your video source settings.
- Adjust the available settings on the projector's **Image** menu for the current input source, such as **Brightness**, **Contrast**, **Tint**, **Color Temp.**, and/or **Color Saturation**.
- Make sure you selected the correct **Input Signal** or **Video Signal** setting in the projector's **Signal** menu, if available for your image source.
 - ☛ **Signal > Advanced > Input Signal**
 - ☛ **Signal > Advanced > Video Signal**
- Make sure you selected the correct **Gamma** or **RGBCMY** setting in the projector's **Image** menu.
 - ☛ **Image > Advanced**
- Make sure all the cables are securely connected to the projector and your video device. If you connected long cables, try connecting shorter cables.
- If you are using **ECO** as **Power Consumption**, try selecting **Normal**.
 - ☛ **ECO > Power Consumption**



At high altitudes or locations subject to high temperatures, the image may become darker and you may not be able to adjust the **Power Consumption** setting.

- Position the projector close enough to the screen.
- If the image has been progressively darkening, you may need to replace the projector lamp soon.

» Related Links

- "Color Mode" [p.72](#)
- "Input Signal Settings - Signal Menu" [p.208](#)
- "Image Quality Settings - Image Menu" [p.206](#)

- "Projector Setup Settings - ECO Menu" [p.233](#)

Solutions to Sound Problems

If there is no sound or the volume is too low or high, try the following solutions:

- Adjust the projector's volume settings.
- Press the [A/V Mute] button on the remote control to resume video and audio if they were temporarily stopped.
- Check your computer or video source to make sure the volume is turned up and the audio output is set for the correct source.
- Disconnect the audio cable, and then reconnect it.
- Check the audio cable connections between the projector and your video source.
- If you do not hear sound from an HDMI source, set the connected device to PCM output.
- Make sure any connected audio cables are labeled "No Resistance".
- If you are using the USB Display function, turn on the **Output audio from the projector** setting in the **Epson USB Display Settings** program on your computer.
- Select the correct audio input in the **A/V Settings** setting in the projector's **Extended** menu.
- When you are connecting the projector to a Mac using an HDMI cable, make sure your Mac supports audio through the HDMI port.
- If you want to use a connected audio source when the projector is off, set the **Standby Mode** option to **Communication On** in the projector's **ECO** menu and make sure the **A/V Settings** options are set correctly in the projector's **Extended** menu.
- If the volume for the computer is set to the minimum while the projector is set to the maximum, the noise may be mixed. Turn up the computer's volume and turn down the projector's volume. (When you use EasyMP Multi PC Projection or USB Display.)

» Related Links

- "Projector Connections" [p.28](#)
- "Projector Setup Settings - Extended Menu" [p.213](#)
- "Projector Setup Settings - ECO Menu" [p.233](#)
- "Controlling the Volume with the Volume Buttons" [p.77](#)

Solutions When Image File Names are not Displayed Correctly in PC Free

If any file names are longer than the display area or include unsupported symbols, the file names are shortened or changed in PC Free. Shorten or change the file name.

Check the solutions in these sections if you have problems operating the projector or remote control.

» Related Links

- "Solutions to Projector Power or Shut-Off Problems" [p.269](#)
- "Solutions to Problems with the Remote Control" [p.269](#)
- "Solutions to Password Problems" [p.270](#)
- "Solution When "The Battery that Saves Your Clock Settings is Running Low" Message Appears" [p.270](#)

Solutions to Projector Power or Shut-Off Problems

If the projector does not turn on when you press the power button or it turns off unexpectedly, try the following solutions:

- Make sure the power cord is securely connected to the projector and to a working electrical outlet.
- The projector's buttons may be locked for security. Unlock the buttons in the **Control Panel Lock** setting in the projector's **Settings** menu or use the remote control to turn on the projector.
☛ **Settings > Lock Setting > Control Panel Lock**
- The power cord may be defective. Disconnect the cord and contact Epson for help.
- If the projector's lamp turns off unexpectedly, it may have entered sleep mode after a period of inactivity. Perform any operation to wake the projector. To turn off sleep mode, select **Off** as the **Sleep Mode** setting in the projector's **ECO** menu.
- If the projector's lamp turns off unexpectedly, the A/V mute timer may be enabled. To turn off the A/V mute timer, select **Off** as the **A/V Mute Timer** setting in the projector's **ECO** menu.
- If the projector's lamp turns off, the status indicator is flashing, and the temp (temperature) indicator is lit, the projector has overheated and turned off.
- If the power button on the remote control does not turn on the projector, check its batteries and make sure at least one of the remote receivers are available in the **Remote Receiver** setting in the projector's **Settings** menu.

» Related Links

- "Projector Setup Settings - ECO Menu" [p.233](#)
- "Projector Indicator Status" [p.260](#)
- "Projector Feature Settings - Settings Menu" [p.210](#)
- "Unlocking the Projector's Buttons" [p.170](#)

Solutions to Problems with the Remote Control

If the projector does not respond to remote control commands, try the following solutions:

- Check that the remote control batteries are installed correctly and have power. If necessary, replace the batteries.
- Make sure you are operating the remote control within the reception angle and range of the projector.
- Make sure the projector is not warming up or shutting down.
- Check to see if a button on the remote control is stuck down, causing it to enter sleep mode. Release the button to wake the remote control up.
- Strong fluorescent lighting, direct sunlight, or infrared device signals may be interfering with the projector's remote receivers. Dim the lights or move the projector away from the sun or interfering equipment.
- Make sure at least one of the remote receivers are available in the **Remote Receiver** setting in the projector's **Settings** menu.
- If the **Remote Receiver** setting is disabled, hold down the [Menu] button on the remote control for at least 15 seconds to reset the setting to its default.
- If you assigned an ID number to the projector to operate multiple projectors from the remote control, you may need to check or change the ID setting.
- If you lose the remote control, you can order another one from Epson.

» Related Links

- "Remote Control Operation" [p.45](#)
- "Projector Feature Settings - Settings Menu" [p.210](#)
- "Selecting the Projector You want to Operate" [p.160](#)
- "Replacing the Remote Control Batteries" [p.254](#)

Solutions to Password Problems

If you cannot enter or remember a password, try the following solutions:

- You may have turned on password protection without first setting a password. Try entering **0000** using the remote control.
- If you have entered an incorrect password too many times and see a message displaying a request code, write down the code and contact Epson for help. Provide the request code and proof of ownership for assistance in unlocking the projector.
- If you lose the remote control you cannot enter a password. Order a new one from Epson.

Solution When "The Battery that Saves Your Clock Settings is Running Low" Message Appears

If the message "The battery that saves your clock settings is running low." is displayed, contact Epson for help.

Check the solutions in these sections if you have problems using the interactive features.

► Related Links

- "Solutions When "Error Occurred in the Easy Interactive Function" Message Appears" [p.271](#)
- "Solutions When the Interactive Pens Do Not Work" [p.271](#)
- "Solutions When Manual Calibration Does Not Work" [p.272](#)
- "Solutions When You Cannot Operate a Computer from the Projected Screen" [p.272](#)
- "Solutions When the Interactive Pen Position Is Not Accurate" [p.272](#)
- "Solutions When the Interactive Pens Are Slow or Difficult to Use" [p.273](#)
- "Solutions When the Interactive Touch Operation Does Not Work" [p.273](#)
- "Solutions for Problems with Capturing, Printing, Saving, or Scanning" [p.273](#)
- "Solutions When Inking Does Not Appear in Microsoft Office" [p.274](#)
- "Solutions for Problems with a Shared Whiteboard" [p.274](#)
- "Solutions When the Time Is Incorrect in Whiteboard Settings" [p.274](#)

Solutions When "Error Occurred in the Easy Interactive Function" Message Appears

If the "Error occurred in the Easy Interactive Function" message appears, contact Epson for help.

Solutions When the Interactive Pens Do Not Work

If the interactive pens do not work, try the following solutions:

- Make sure you are not covering the black section near the tip of the pen.
- Try holding the pen at a different angle so that your hand is not blocking the signal.
- Press the button on the side of the pen to check the remaining battery power. If the battery indicator does not turn on, replace the battery.
- Make sure the pen tip is securely attached to the pen.

- If the pen tip is worn out or damaged, you may need to replace it.
- Make sure nothing is blocking the signal between the pen and the interactive pen receiver on the projector.
- Make sure the cable cover is in place to keep cables from blocking the signal.
- Dim the room lights and turn off any fluorescent lights. Make sure the projection surface and pen receiver are not in direct sunlight or other sources of bright lighting.
- Make sure the interactive pen receiver on the projector is clean and free from dust.
- Make sure there is no interference from infrared remote controls, mice, or infrared microphones.
- Make sure you perform pen calibration when using the interactive pen for the first time so that the projector recognizes the position of the pen correctly.
- Make sure **Pen Mode** and **Pen Operation Mode** settings are set correctly in the **Easy Interactive Function** options on the **Extended** menu.
- When using multiple projectors and interactive pens in the same room, interference may cause pen operations to become unstable. Connect the optional remote control cable set. If you do not have a remote control cable set, change the **Distance of Projectors** setting in the projector's **Extended** menu.
 - ☛ **Extended** > **Easy Interactive Function** > **General** > **Advanced** > **Distance of Projectors**
- Try replacing the soft pen tip with the hard pen tip. Doing so may improve pen operations because some of the projector models do not support the soft pen tip.

► Related Links

- "Replacing the Interactive Pen Tip" [p.256](#)
- "Pen Calibration" [p.82](#)
- "Projector Setup Settings - Extended Menu" [p.213](#)
- "Replacing the Interactive Pen Battery" [p.255](#)

Solutions When Manual Calibration Does Not Work

If you are having trouble calibrating manually, try the following solutions:

- Make sure the projector is not too close to the projection surface.
- Move the projector or turn off the interfering device, such as a light source that is emitting infrared rays.

Solutions When You Cannot Operate a Computer from the Projected Screen

If you cannot operate a computer from the projected screen, try the following solutions:

- Make sure the **USB Type B** option on the **Extended** menu is set to **Easy Interactive Function** or **USB Display/Easy Interactive Function**.
- Make sure you perform pen calibration when using the interactive pen for the first time so that the projector recognizes the position of the pen correctly.
- Press the [Pen Mode] button on the remote control to select **PC Interactive** as the **Pen Mode** setting. You can also select the **Pen Mode** setting from the projector's **Extended** menu.
 - ☛ **Extended > Easy Interactive Function > Pen Mode**
- Make sure the USB cable is securely connected. Disconnect the USB cable, and then reconnect it.
- When projecting an image using two projectors installed side by side, you need to select the **Multi-Projection** setting to use the interactive features. You also need to install Easy Interactive Driver Ver. 4.0 from the Epson Projector Software for Easy Interactive Function CD-ROM on the computer that you want to operate from the projected screen.
 - ☛ **Extended > Easy Interactive Function > Advanced > Multi-Projection**
- When projecting an image with only one of the two projectors installed side by side, you may not be able to operate a computer from the projected

screen. Select the  icon on the Home screen, and then set **Use this single projector** to **On**.

► Related Links

- "Pen Calibration" [p.82](#)
- "Projector Setup Settings - Extended Menu" [p.213](#)

Solutions When the Interactive Pen Position Is Not Accurate

If the pen position is not the same as the mouse pointer, try the following solutions:

- Make sure you perform pen calibration when using the interactive pen for the first time so that the projector recognizes the position of the pen correctly. If the cursor location and pen position do not match after auto calibration, you can calibrate manually.
 - Make sure the cable cover is in place to keep cables from blocking the signal.
 - Try adjusting the pen operation area.
 - If you use the [E-Zoom] + button on the remote control to enlarge the image, the pen position is not accurate. When you return the image to the original size, the position should be correct.
 - If you set **Pen Mode** to **PC Interactive** in the projector's **Extended** menu, set **Auto Adjust Pen Area** to **Off**, and then select **Manual Adj. Pen Area**.
 - ☛ **Extended > Easy Interactive Function > General > Advanced > Auto Adjust Pen Area**
 - ☛ **Extended > Easy Interactive Function > General > Advanced > Manual Adj. Pen Area**
- ### ► Related Links
- "Pen Calibration" [p.82](#)
 - "Projector Setup Settings - Extended Menu" [p.213](#)
 - "Adjusting the Pen Operation Area" [p.123](#)

Solutions When the Interactive Pens Are Slow or Difficult to Use

If the pens are difficult to use or respond too slowly, try the following solutions:

- For easier operation, hold the pen perpendicular to the projection surface.
- For the best performance, connect your computer to the projector using a VGA or HDMI cable for display and the USB cable for the interactive features.
- If you are using USB Display in Windows, you may need to disable Windows Aero in the **Epson USB Display Settings** program on your computer.

» Related Links

- "Projector Connections" [p.28](#)

Solutions When the Interactive Touch Operation Does Not Work

If the interactive touch operation using your finger does not work, try the following solutions (EB-1450Ui):

- Make sure the Touch Unit is installed correctly and the power cable is properly connected. See your projector's *Installation Guide* for details.
- If the indicator on the Touch Unit is not on, check that **Touch Unit Setup - Power** is set to **On** in the projector's **Extended** menu.
- Adjust the angle on the Touch Unit. See your projector's *Installation Guide* for details.
- Make sure there are no obstacles (such as cables or pen stand) between the Touch Unit's laser diffusion port and the projection surface. If there are any obstacles that are difficult to move, attach the infrared deflectors to the projection surface. See your projector's *Installation Guide* for details.
- Make sure there is no interference from infrared remote controls, mice, or infrared microphones.

- If your finger position and the cursor position on the screen do not match, perform **Touch Calibration** in the projector's **Extended** menu.
- If there are any people within 10 cm in front of or around the projection screen or any obstacles causing interference, the touch operations may not work properly.
- If clothing, or any part of your body comes close to the screen, the touch operations may not work properly. Move at least 1 cm away from the screen.
- If touch operations do not work correctly even after performing calibration, press the  icon on the Home screen to check the **Calibration Range** setting.
 - If touch operations are mistakenly recognized as dragging operations, select **Wide**.
 - If mouse operations are not performed smoothly, select **Narrow**.

» Related Links

- "Projector Setup Settings - Extended Menu" [p.213](#)
- "Using Interactive Touch Operations with Your Finger" [p.85](#)

Solutions for Problems with Capturing, Printing, Saving, or Scanning

If you are having trouble capturing and pasting, or printing, saving, or scanning, try the following solutions:

- If you are having trouble pasting a captured image, make sure the image is not protected.
- If a black frame appears around a pasted image, it may be because the image was shifted or resized.
- If you are having trouble printing or scanning, make sure the printer is not out of ink, jammed, or in any other error state.
- For USB printing or scanning, make sure a USB cable is connected between the projector's USB-A port and the USB-B port on the control pad. Make

sure another USB cable is connected between the Printer port (USB-A port) on the control pad and the printer itself.

- For USB printing or scanning, try connecting a different USB cable, and make sure the cables are less than 4.9 m long.
- When scanning from the ADF, make sure you load paper in advance.
- Connect only one printer or multifunction device at a time, and make sure the device is supported by the projector.
- Check the **Whiteboard Settings** on the projector's **Extended** menu.

Solutions When Inking Does Not Appear in Microsoft Office



If **Start Inking** does not appear on the **Review** tab in your Microsoft Office application, try this solution.

Open the projector's **Extended** menu and change the **Pen Operation Mode** setting in **Easy Interactive Function**:

Solutions for Problems with a Shared Whiteboard

If you are having problems with a shared whiteboard, try the following solutions:

- Connect the projector to the same network as the projector that is sharing its whiteboard.
- If you enter the wrong PIN code 10 times in 10 minutes, you cannot connect to the whiteboard for three minutes. Try again after three minutes.
- Make sure **Sharing** is displayed on the status bar. If it is not displayed, re-connect to the shared whiteboard.
- If you want to save the shared whiteboard screen as a file from a Web browser, follow the steps below:

1. Select the  icon on the bottom tool bar and select **Stop Sharing**, or select the  icon on the status bar.
2. Select **Distribute to Participants**.
3. Select **Save** depending on the message displayed on the device to which you want to save the screen.
4. Save the file on the device. For details, see the documentation supplied with the device.

Solutions When the Time Is Incorrect in Whiteboard Settings

If the time is incorrect on internal storage settings for whiteboard mode, you may need to update the **Date & Time** settings on the projector's **Extended** menu.

☛ **Extended** > **Operation** > **Date & Time**

Check the solutions in these sections if you have problems using the projector on a network.

► Related Links

- "Solutions When Wireless Authentication Fails" [p.275](#)
- "Solutions When You Cannot Access the Projector Through the Web" [p.275](#)
- "Solutions When Network Alert E-Mails are not Received" [p.275](#)
- "Solutions When the Image Contains Static During Network Projection" [p.275](#)

Solutions When Wireless Authentication Fails

If you are having trouble with the authentication, try the following solutions:

- If the wireless settings are correct, but authentication fails, you may need to update the **Date & Time** settings on the projector's **Extended** menu.
 - ☛ **Extended** > **Operation** > **Date & Time**
- Check the **Security** settings in the projector's **Network** menu.
 - ☛ **Network** > **Network Configuration** > **Wireless LAN**

Solutions When You Cannot Access the Projector Through the Web

If you are unable to access the projector through a Web browser, make sure you are using the correct ID and password.

- To display the Web Control screen, enter **EPSONWEB** as the user ID. (You cannot change the user ID.)
- To display the Web Remote screen, enter **EPSONREMOTE** as the user ID. (You cannot change the user ID.)
- For the password, enter the password set in the projector's **Network** menu. The default password is **admin**.
 - ☛ **Network** > **Network Configuration** > **Basic** > **Web Control Password**
 - ☛ **Network** > **Network Configuration** > **Basic** > **Remote Password**
- Make sure you have access to the network the projector is on.

- If your Web browser is set up to connect via a proxy server, the Web Control screen cannot be displayed. Make settings for a connection without using a proxy server.



The user ID and password are case sensitive.

► Related Links

- "Network Menu - Basic Menu" [p.226](#)

Solutions When Network Alert E-Mails are not Received

If you do not receive an e-mail alerting you to problems with a projector over the network, try the following solutions:

- Make sure the projector is turned on and connected to the network correctly. (If an error shuts down the projector, the email may not be delivered.)
- Make sure you set up the projector e-mail alert settings correctly on the projector's network **Notifications** menu or in the network software.
- Set the **Standby Mode** setting to **Communication On** in the projector's **ECO** menu so the network software can monitor the projector in standby mode.
- Make sure your electrical outlet or power source is functioning correctly.

► Related Links

- "Network Menu - Notifications Menu" [p.230](#)

Solutions When the Image Contains Static During Network Projection

If the projected image contains static during network projection, try the following solutions:

- Check for any obstacles between the access point, the computer, the mobile device, and the projector, and change their positions to improve communication.
- Make sure that the access point, the computer, the mobile device and the projector are not too far apart. Move them closer together and try to connect again.
- If the wireless connection is slow or your projected image contains noise, check for interference from other equipment, such as a Bluetooth device or microwave. Move the interfering device farther away or expand your wireless bandwidth.
- Reduce the number of connected devices if the connection speed declines.

Appendix

Check these sections for the technical specifications and important notices about your projector.

► **Related Links**

- "Optional Accessories and Replacement Parts" [p.278](#)
- "Screen Size and Projection Distance" [p.280](#)
- "Supported Monitor Display Resolutions" [p.281](#)
- "Projector Specifications" [p.283](#)
- "Connector Specifications" [p.284](#)
- "External Dimensions" [p.285](#)
- "USB Display System Requirements" [p.287](#)
- "Easy Interactive Driver System Requirements" [p.288](#)
- "List of Safety Symbols (corresponding to IEC60950-1 A2)" [p.289](#)
- "Glossary" [p.291](#)
- "Notices" [p.293](#)

The following optional accessories and replacement parts are available. Please purchase these products as and when needed.

The following list of optional accessories and replacement parts is current as of: September 2016.

Details of accessories are subject to change without notice and availability may vary depending on the country of purchase.

► Related Links

- "Cables" [p.278](#)
- "Mounts" [p.278](#)
- "For Interactive Feature" [p.278](#)
- "For Wireless Connection" [p.278](#)
- "External Devices" [p.279](#)
- "Replacement Parts" [p.279](#)

Cables

Computer cable ELPKC02 (1.8 m - for mini D-sub 15-pin/mini D-Sub 15pin)

Computer cable ELPKC09 (3 m - for mini D-sub 15-pin/mini D-Sub 15pin)

Computer cable ELPKC10 (20 m - for mini D-sub 15-pin/mini D-Sub 15pin)

Use when connecting to the Computer port.

Component video cable ELPKC19 (3 m - for mini D-Sub 15-pin/RCA male x 3)

Use when connecting to a component video source.

Remote Control Cable Set ELPKC28

Use when connecting multiple projectors that support the interactive feature.

Mounts

Setting plate ELPMB46

Use when installing the projector on a wall.

Ceiling mount ELPMB23

Use when installing the projector on a ceiling.

Ceiling pipe (450 mm) ELPFP13

Ceiling pipe (700 mm) ELPFP14

Use when installing the projector on a high ceiling.

Interactive Table Mount ELPMB29

Use when installing the projector on a table.



Special expertise is required to suspend the projector from a ceiling. Contact Epson for help.

For Interactive Feature

Interactive Pen ELPPN05A

Interactive Pen ELPPN05B

Use when operating the computer screen on the projection surface.

Replacement Hard Pen Tips ELPPS03

Replacement Soft Pen Tips ELPPS04

Replacement pen tips for the interactive pen.

For Wireless Connection

Wireless LAN module ELPAP10

Use this to project images from a computer via a wireless communication. (Frequency band: 2.4GHz)

External Devices

Document Camera ELPDC21

Use when projecting image such as books, OHP documents, or slides.

External Speaker ELPSP02

External self-powered speaker.

Replacement Parts

Lamp unit ELPLP92

Use as a replacement for used lamps.

Air filter ELPAF45

Use as a replacement for used air filters.

Check the table here to determine how far to place the projector from the screen based on the size of the projected image.

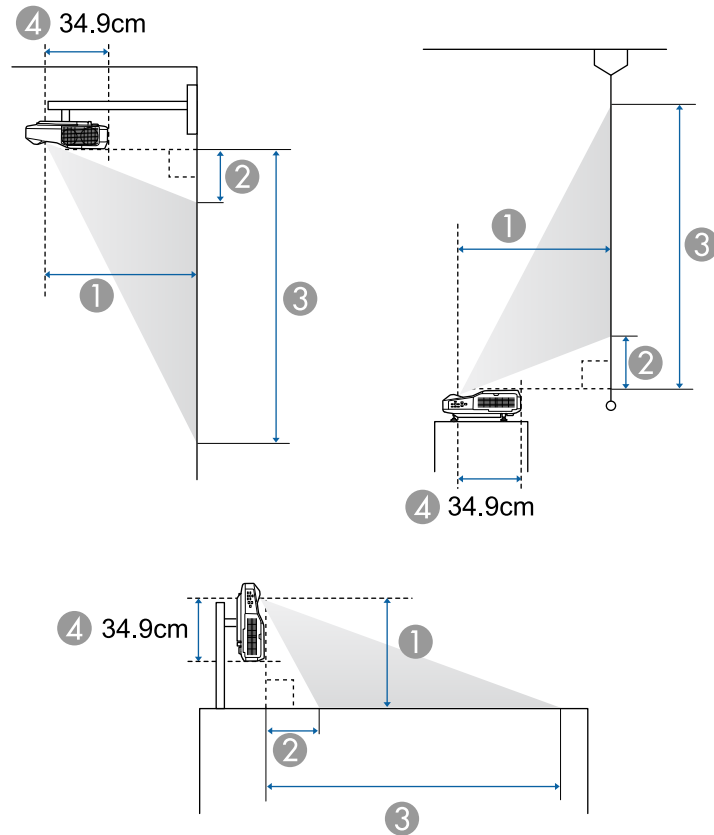

- ① Projection distance (cm)
- ② Distance from the projector to the top of the screen (when mounting on a wall or ceiling, or installing vertically) (cm)
Distance from the projector to the bottom of the screen (when placing on a surface such as a desk) (cm)

- ③ Distance from the projector to the bottom of the screen (when mounting on a wall or ceiling, or installing vertically) (cm)
Distance from the projector to the top of the screen (when placing on a surface such as a desk) (cm)
- ④ Distance from the center of the lens to the rear of the projector (cm)

16:10 screen size		①	②	③
		Minimum (Wide) to Maximum (Tele)	Minimum (Wide)	Minimum (Wide)
70"	151 × 94	40.5 - 55.8	12.9	107.2
80"	172 × 108	46.7 - 64.3	15.7	123.4
90"	194 × 121	53.0 - 72.8	18.6	139.7
100"	215 × 135	59.3*	21.4	156.0

* Project using Wide (maximum zoom).

The table here lists the compatible refresh rate and resolution for each compatible video display format.

Component Signals (Analog RGB)

Signal	Refresh rate (Hz)	Resolution (dots)
VGA	60/72/75/85	640 × 480
SVGA	60/72/75/85	800 × 600
XGA	60/70/75/85	1024 × 768
WXGA	60	1280 × 768
	60	1366 × 768
	60/75/85	1280 × 800
WXGA+	60/75/85	1440 × 900
WXGA++	60	1600 × 900
SXGA	70/75/85	1152 × 864
	60/75/85	1280 × 960
	60/75/85	1280 × 1024
SXGA+	60/75	1400 × 1050
WSXGA+ *	60	1680 × 1050
UXGA	60	1600 × 1200
WUXGA (Reduced Blanking)	60	1920 × 1200

* Only compatible when **Wide** is selected as the **Resolution** setting in the projector's **Signal** menu.

Even when signals other than those mentioned above are input, it is likely that the image can be projected. However, not all functions may be supported.

Component Video

Signal	Refresh rate (Hz)	Resolution (dots)
SDTV (480i/480p)	60	720 × 480

Signal	Refresh rate (Hz)	Resolution (dots)
SDTV (576i/576p)	50	720 × 576
HDTV (720p)	50/60	1280 × 720
HDTV (1080i)	50/60	1920 × 1080

Composite Video

Signal	Refresh rate (Hz)	Resolution (dots)
TV (NTSC)	60	720 × 480
TV (SECAM)	50	720 × 576
TV (PAL)	50/60	720 × 576

HDMI Input Signal

Signal	Refresh rate (Hz)	Resolution (dots)
VGA	60	640 × 480
SVGA	60	800 × 600
XGA	60	1024 × 768
WXGA	60	1280 × 800
	60	1366 × 768
WXGA+	60	1440 × 900
WXGA++	60	1600 × 900
SXGA	60	1280 × 960
	60	1280 × 1024
SXGA+	60	1400 × 1050
WSXGA+	60	1680 × 1050
UXGA	60	1600 × 1200
WUXGA (Reduced Blanking)	60	1920 × 1200
SDTV (480i/480p)	60	720 × 480

Signal	Refresh rate (Hz)	Resolution (dots)
SDTV (576i/576p)	50	720 × 576
HDTV (720p)	50/60	1280 × 720
HDTV (1080i)	50/60	1920 × 1080
HDTV (1080p)	24/30/50/60	1920 × 1080

MHL Input Signal

Signal	Refresh rate (Hz)	Resolution (dots)
VGA	60	640 × 480
SDTV (480i/480p)	60	720 × 480
SDTV (576i/576p)	50	720 × 576
HDTV (720p)	50/60	1280 × 720
HDTV (1080i)	50/60	1920 × 1080
HDTV (1080p)	24/30	1920 × 1080

Product name	EB-1450Ui/EB-1440Ui	
Dimensions	474 (W) x 130(H) x 447(D) mm (not including raised section)	
LCD panel size	0.67"	
Display method	Poly-silicon TFT active matrix	
Resolution	2,304,000 pixels WUXGA (1,920 (W) x 1,200 (H) dots) x 3	
Focus adjustment	Manual	
Zoom adjustment	1.0 - 1.35 (Digital Zoom)	
Lamp	UHE lamp, 267W Model No.: ELPLP92	
Lamp life	Normal Power Consumption mode: Up to 5,000 hours ECO Power Consumption mode: Up to 10,000 hours	
Max. audio output	16W	
Speaker	1	
Power supply	100-240V AC±10% 50/60Hz 4.3 - 1.9 A	
Power consumption	100 to 120 V area	Operating: 425 W Standby power consumption (Communication On): 2.81 W Standby power consumption (Communication Off): 0.23 W
	220 to 240 V area	Operating: 401 W Standby power consumption (Communication On): 2.87 W Standby power consumption (Communication Off): 0.32 W
Operating altitude	Altitude 0 to 3,000 m	

Operating temperature	+5 to +40°C* (No condensation) (Altitude 0 to 2,286 m) +5 to +35°C* (No condensation) (Altitude 2,287 to 3,000 m)
	When using multiple projectors at the same time: +5 to +35°C* (No condensation) (Altitude 0 to 2,286 m) +5 to +30°C* (No condensation) (Altitude 2,287 to 3,000 m)
Storage temperature	-10 to +60°C (No condensation)
Mass	Approx. 8.4 kg

* If the surrounding temperature gets too high, the brightness is automatically dimmed.

This product is also designed for IT power distribution system with phase-to-phase voltage 230V.

Angle of tilt

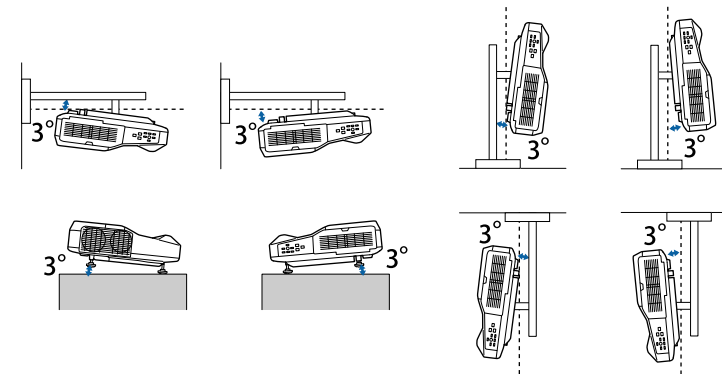

If you use the projector tilted at an angle of more than 3° it could be damaged and cause an accident.

Computer port	1	Mini D-Sub15-pin (female)
Monitor Out port	1	Mini D-Sub15-pin (female)
Video port	1	RCA pin jack
Audio port	2	stereo mini pin jack
Audio Out port	1	stereo mini pin jack
HDMI1/MHL port	1	HDMI (Audio is only supported by PCM)
HDMI2 port	1	HDMI (Audio is only supported by PCM)
DVI-D Out port	1	DVI-D 24pin Single link
USB-A port	2	USB connector (Type A)
USB-B port	1	USB connector (Type B)
USB port (for Wireless LAN module)	1	USB connector (Type A)
LAN port	1	RJ-45
RS-232C port	1	Mini D-Sub 9-pin (male)
SYNC port	2	Stereo mini pin jack
TCH port (EB-1450Ui)	1	Mini DIN 8-pin
Remote port	1	Stereo mini pin jack



- USB-A and USB-B port supports USB 2.0. However, USB ports are not guaranteed to operate all devices that support USB.
- USB-B port is not support USB 1.1.

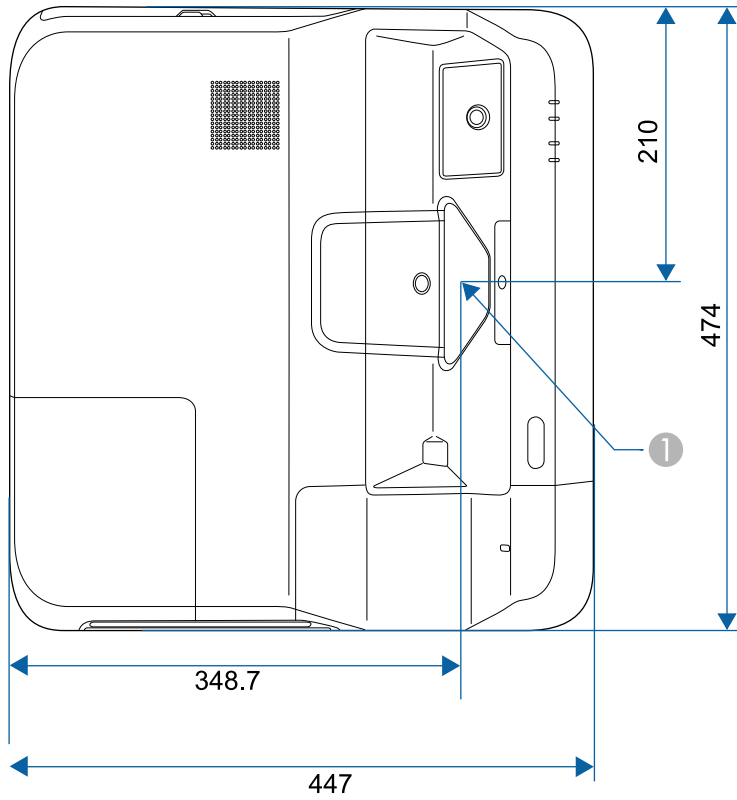

- ① Center of the lens
- ② Distance from the top to the ceiling mount fixing points

The unit in these illustrations is mm.

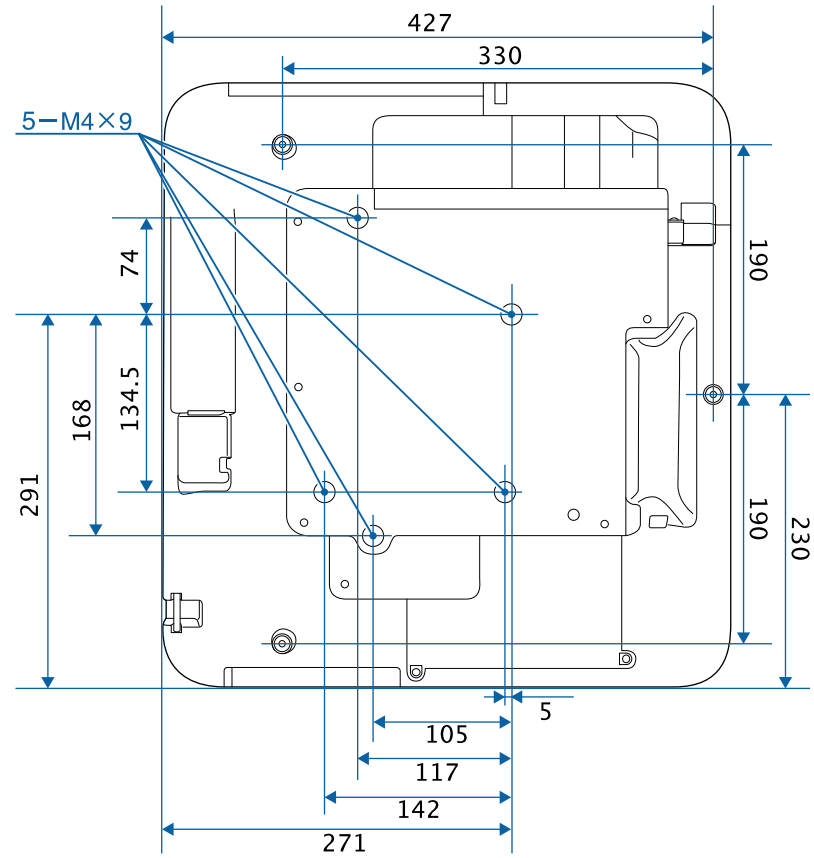

Without feet

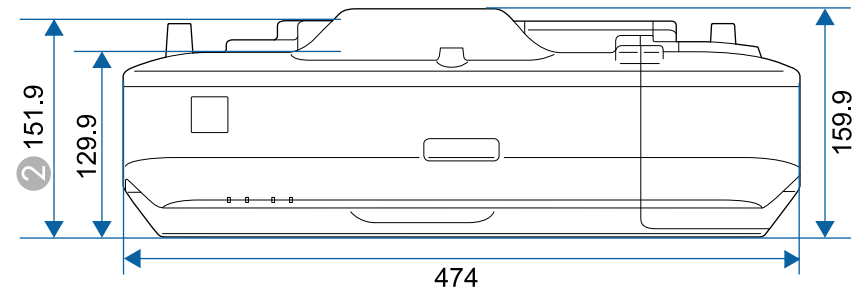

With feet

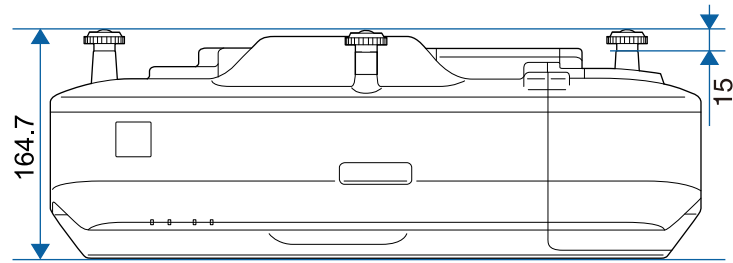

To use the projector's Epson USB Display software, your computer must meet the following system requirements.

Requirement	Windows	Mac
Operating system	Windows Vista <ul style="list-style-type: none"> • Ultimate (32-bit) • Enterprise (32-bit) • Business (32-bit) • Home Premium (32-bit) • Home Basic (32-bit) 	OS X <ul style="list-style-type: none"> • 10.7.x (32- and 64-bit) • 10.8.x (64-bit) • 10.9.x (64-bit) • 10.10.x (64-bit) • 10.11.x (64-bit)
	Windows 7 <ul style="list-style-type: none"> • Ultimate (32- and 64-bit) • Enterprise (32- and 64-bit) • Professional (32- and 64-bit) • Home Premium (32- and 64-bit) • Home Basic (32-bit) • Starter (32-bit) 	
	Windows 8 <ul style="list-style-type: none"> • Windows 8 (32- and 64-bit) • Windows 8 Pro (32- and 64-bit) • Windows 8 Enterprise (32- and 64-bit) 	
	Windows 8.1 <ul style="list-style-type: none"> • Windows 8.1 (32- and 64-bit) • Windows 8.1 Pro (32- and 64-bit) • Windows 8.1 Enterprise (32- and 64-bit) 	

Requirement	Windows	Mac
	Windows 10 <ul style="list-style-type: none"> • Windows 10 Home (32- and 64-bit) • Windows 10 Pro (32- and 64-bit) • Windows 10 Enterprise (32- and 64-bit) 	
CPU	Intel Core2Duo or faster (Intel Core i3 or faster recommended)	Intel Core2Duo or faster (Intel Core i5 or faster recommended)
Memory	2GB or more (4GB or more recommended)	
Hard disk space	20 MB or more	
Display	Resolution between 640 × 480 and 1920 × 1200 16-bit color or greater	











Operation is not guaranteed for Windows Vista without any service packs installed, or Windows Vista Service Pack 1.







To use computer interactive mode, you must install the Easy Interactive Driver on your computer. Check the system requirements necessary to run the software.





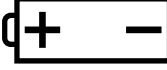



Requirement	Windows	Mac
Operating system	Windows 7 <ul style="list-style-type: none"> • Ultimate (32- and 64-bit) • Enterprise (32- and 64-bit) • Professional (32- and 64-bit) • Home Premium (32- and 64-bit) • Home Basic (32-bit) 	OS X <ul style="list-style-type: none"> • OS X 10.7.x (32- and 64-bit) • OS X 10.8.x (64-bit) • OS X 10.9.x (64-bit) • OS X 10.10.x (64-bit) • OS X 10.11.x (64-bit)
	Windows 8 <ul style="list-style-type: none"> • Windows 8 (32- and 64-bit) • Windows 8 Pro (32- and 64-bit) • Windows 8 Enterprise (32- and 64-bit) 	
	Windows 8.1 <ul style="list-style-type: none"> • Windows 8.1 (32- and 64-bit) • Windows 8.1 Pro (32- and 64-bit) • Windows 8.1 Enterprise (32- and 64-bit) 	
	Windows 10 <ul style="list-style-type: none"> • Windows 10 Home (32- and 64-bit) • Windows 10 Pro (32- and 64-bit) • Windows 10 Enterprise (32- and 64-bit) 	
CPU	Core2 Duo 1.2 GHz or faster (Core i3 or faster recommended)	Core2 Duo 1.2 GHz or faster (Core i5 or faster recommended)

Requirement	Windows	Mac
Memory	1 GB or more Recommended: 2 GB or more	1 GB or more Recommended: 2 GB or more
Hard disk space	100 MB or more	100 MB or more
Display	Resolutions no lower than XGA (1024 x 768) and no higher than WUXGA (1920 x 1200) 16-bit color or greater	Resolutions no lower than XGA (1024 x 768) and no higher than WUXGA (1920 x 1200) 16-bit color or greater

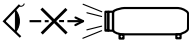
The following table lists the meaning of the safety symbols labeled on the equipment.

No.	Symbol mark	Approved standards	Description
1		IEC60417 No.5007	"ON" (power) To indicate connection to the mains.
2		IEC60417 No.5008	"OFF" (power) To indicate disconnection from the mains.
3		IEC60417 No.5009	Stand-by To identify the switch or switch position by means of which part of the equipment is switched on in order to bring it into the stand-by condition.
4		ISO7000 No.0434B, IEC3864-B3.1	Caution To identify general caution when using the product.
5		IEC60417 No.5041	Caution, hot surface To indicate that the marked item can be hot and should not be touched without taking care.
6		IEC60417 No.6042 ISO3864-B3.6	Caution, risk of electric shock To identify equipment that has risk of electric shock.
7		IEC60417 No.5957	For indoor use only To identify electrical equipment designed primarily for indoor use.
8		IEC60417 No.5926	Polarity of d.c. power connector To identify the positive and negative connections (the polarity) on a piece of equipment to which a d.c. power supply may be connected.

No.	Symbol mark	Approved standards	Description
9		—	The same as No.8.
10		IEC60417 No.5001B	Battery, general On battery powered equipment. To identify a device for instance a cover for the battery compartment, or the connector terminals.
11		IEC60417 No.5002	Positioning of cell To identify the battery holder itself and to identify the positioning of the cell(s) inside the battery holder.
12		—	The same as No.11.
13		IEC60417 No.5019	Protective earth To identify any terminal which is intended for connection to an external conductor for protection against electric shock in case of a fault, or the terminal of a protective earth electrode.
14		IEC60417 No.5017	Earth To identify an earth (ground) terminal in cases where neither the symbol No.13 is explicitly required.
15		IEC60417 No.5032	Alternating current To indicate on the rating plate that the equipment is suitable for alternating current only; to identify relevant terminals.
16		IEC60417 No.5031	Direct current To indicate on the rating plate that the equipment is suitable for direct current only; to identify relevant terminals.

No.	Symbol mark	Approved standards	Description
17		IEC60417 No.5172	Class II equipment To identify equipment meeting the safety requirements specified for Class II equipment according to IEC 61140.
18		ISO 3864	General prohibition To identify actions or operations that are prohibited.
19		ISO 3864	Contact prohibition To indicate injury that could occur due to touching a specific part of the equipment.
20		—	Never look into the optical lens while the projector is on.
21		—	To indicate that the marked item don't place anything on projector.
22		ISO3864 IEC60825-1	Caution, laser radiation To indicate the equipment has a laser radiation part.
23		ISO 3864	Disassembly prohibition To indicate a risk of injury, such as electric shock, if the equipment is disassembled.
24		IEC60417 No. 5266	Standby, partial standby To indicate that part of the equipment is in the ready status.
25		ISO3864 IEC60417 No. 5057	Caution, movable parts To indicate that you must keep away from movable parts according to protection standards.

This section briefly explains the difficult terms that are not explained in the text of this guide. For details, refer to other commercially available publications.

Aspect Ratio	The ratio between an image's length and its height. Screens with a horizontal:vertical ratio of 16:9, such as HDTV screens, are known as wide screens. SDTV and general computer displays have an aspect ratio of 4:3.
Component Video	A method that separates the video signal into a luminance component (Y), and a blue minus luminance (Cb or Pb) and a red minus luminance (Cr or Pr).
Composite Video	A method that combines the video signal into a luminance component and a color component for transmission down a single cable.
Contrast	The relative brightness of the light and dark areas of an image can be increased or decreased to make text and graphics stand out more clearly, or to make them appear softer. Adjusting this particular property of an image is called contrast adjustment.
DHCP	An abbreviation of Dynamic Host Configuration Protocol, this protocol automatically assigns an IP address to equipment connected to a network.
Gateway Address	This is a server (router) for communicating across a network (subnet) divided according to subnet mask.
HDCP	HDCP is an abbreviation for High-bandwidth Digital Content Protection. It is used to prevent illegal copying and protect copyrights by encrypting digital signals sent over DVI and HDMI ports. Because the HDMI port on this projector supports HDCP, it can project digital images protected by HDCP technology. However, the projector may not be able to project images protected with updated or revised versions of HDCP encryption.

HDMI™	An abbreviation for High Definition Multimedia Interface. HDMI™ is a standard aimed at digital consumer electronics and computers. This is the standard by which HD images and multichannel audio signals are digitally transmitted. By not compressing the digital signal, the image can be transferred at the highest quality possible. It also provides an encryption function for the digital signal.
HDTV	An abbreviation for High-Definition Television that refers to high-definition systems which satisfy the following conditions: <ul style="list-style-type: none"> • Vertical resolution of 720p or 1080i or greater (p = Progressive, i = Interlace) • Screen aspect ratio of 16:9
Infrastructure mode	A method for wireless LAN connection in which devices communicate through access points.
Interlace	Transmits information needed to create one screen by sending every other line, starting from the top of the image and working down to the bottom. Images are more likely to flicker because one frame is displayed every other line.
IP Address	A number to identify a computer connected to a network.
MHL	An abbreviation for Mobile High-definition Link, a standard for connection interfaces aimed at mobile devices such as smartphones and tablets. Images can be transferred at high quality and at high speeds without compressing the digital signal, and also charges connected devices.
Progressive	Projects information to create one screen at a time, displaying the image for one frame. Even though the number of scan lines is the same, the amount of flicker in images decreases because the volume of information has doubled compared with an interlace system.
Refresh Rate	The light-emitting element of a display maintains the same luminosity and color for an extremely short time. Because of this, the image must be scanned many times per second to refresh the light-emitting element. The number of refresh operations per second is called the Refresh rate and is expressed in hertz (Hz).

SDTV	An abbreviation for Standard Definition Television that refers to standard television systems which do not satisfy the conditions for HDTV High-Definition Television.
SSID	SSID is identification data for connecting to another device on a wireless LAN. Wireless communication is possible between devices with the same SSID.
Subnet Mask	This is a numerical value that defines the number of bits used for the network address on a divided network (subnet) from the IP address.
SVGA	A screen size standard with a resolution of 800 (horizontal) × 600 (vertical) dots.
SXGA	A screen size standard with a resolution of 1,280 (horizontal) × 1,024 (vertical) dots.
Sync.	The signals output from computers have a specific frequency. If the projector frequency does not match this frequency, the resulting images are not of a good quality. The process of matching the phases of these signals (the relative position of the crests and the troughs in the signal) is called Synchronization. If the signals are not synchronized, flickering, blurriness, and horizontal interference occur.
Tracking	The signals output from computers have a specific frequency. If the projector frequency does not match this frequency, the resulting images are not of a good quality. The process of matching the frequency of these signals (the number of crests in the signal) is called Tracking. If Tracking is not carried out correctly, wide vertical stripes appear in the signal.
VGA	A screen size standard with a resolution of 640 (horizontal) × 480 (vertical) dots.
XGA	A screen size standard with a resolution of 1,024 (horizontal) × 768 (vertical) dots.
WXGA	A screen size standard with a resolution of 1,280 (horizontal) × 800 (vertical) dots.

Check these sections for important notices about your projector.

► **Related Links**

- "FCC Compliance Statement" [p.293](#)
- "Indication of the manufacturer and the importer in accordance with requirements of EU directive" [p.294](#)
- "Restriction of Use" [p.294](#)
- "Operating System References" [p.294](#)
- "Trademarks" [p.294](#)
- "Copyright Notice" [p.295](#)
- "Copyright Attribution" [p.295](#)

FCC Compliance Statement

DECLARATION of CONFORMITY

According to 47CFR, Part 2 and 15
Class B Personal Computers and Peripherals; and/or
CPU Boards and Power Supplies used with Class B Personal Computers

We: Epson America, Inc.

Located at: 3840 Kilroy Airport Way MS: 3-13 Long Beach, CA 90806

Tel: 562-981-3840

Declare under sole responsibility that the product identified herein, complies with 47CFR Part 2 and 15 of the FCC rules as a Class B digital device. Each product marketed, is identical to the representative unit tested and found to be compliant with the standards. Records maintained continue to reflect the equipment being produced can be expected to be within the variation accepted, due to quantity production and testing on a statistical basis as required by 47CFR 2.909. Operation is subject to the following two conditions : (1) this device may not cause harmful interference, and (2) this device must accept any interference received, including interference that may cause undesired operation.

Trade Name: EPSON

Type of Product: LCD Projector

Model: H727C/H771C

FCC Compliance Statement For United States Users

This equipment has been tested and found to comply with the limits for a Class B digital device, pursuant to Part 15 of the FCC Rules. These limits are designed to provide reasonable protection against harmful interference in a residential installation. This equipment generates, uses, and can radiate radio frequency energy and, if not installed and used in accordance with the instructions, may cause harmful interference to radio communications. However, there is no guarantee that interference will not occur in a particular installation. If this equipment does cause interference to radio and television reception, which can be determined by turning the equipment off and on, the user is encouraged to try to correct the interference by one or more of the following measures.

- Reorient or relocate the receiving antenna.
- Increase the separation between the equipment and receiver.
- Connect the equipment into an outlet on a circuit different from that to which the receiver is connected.
- Consult the dealer or an experienced radio/TV technician for help.

WARNING

The connection of a non-shielded equipment interface cable to this equipment will invalidate the FCC Certification or Declaration of this device and may cause interference levels which exceed the limits established by the FCC for this equipment. It is the responsibility of the user to obtain and use a shielded equipment interface cable with this device. If this equipment has more than one interface connector, do not leave cables connected to unused interfaces. Changes or modifications not expressly approved by the manufacturer could void the user's authority to operate the equipment.

Since the Easy Interactive Pen is small, FCC Statement for Verification is written in the manual.

FCC Statement for Verification

This device complies with Part 15 of the FCC Rules. Operation is subject to the following two conditions: (1) this device may not cause harmful interference, and (2) this device must accept any interference received, including interference that may cause undesired operation.

Indication of the manufacturer and the importer in accordance with requirements of EU directive

Manufacturer: SEIKO EPSON CORPORATION
 Address: 3-5, Owa 3-chome, Suwa-shi, Nagano-ken 392-8502 Japan
 Telephone: 81-266-52-3131
<http://www.epson.com/>

Importer: EPSON EUROPE B.V.
 Address: Atlas Arena, Asia Building, Hoogoorddreef 5,1101 BA Amsterdam
 Zuidoost
 The Netherlands
 Telephone: 31-20-314-5000
<http://www.epson.com/europe.html>

Restriction of Use

When this product is used for applications requiring high reliability/safety such as transportation devices related to aviation, rail, marine, automotive etc.; disaster prevention devices; various safety devices etc; or functional/precision devices etc, you should use this product only after giving consideration to including fail-safes and redundancies into your design to maintain safety and total system reliability. Because this product was not intended for use in applications requiring extremely high reliability/safety such as aerospace equipment, main communication equipment, nuclear power control equipment, or medical equipment related to direct medical care etc, please make your own judgment on this product's suitability after a full evaluation.

Operating System References

- Microsoft® Windows Vista® operating system

- Microsoft® Windows® 7 operating system
- Microsoft® Windows® 8 operating system
- Microsoft® Windows® 8.1 operating system
- Microsoft® Windows® 10 operating system
- Microsoft® Windows Server® 2008 operating system
- Microsoft® Windows Server® 2012 operating system

In this guide, the operating systems above are referred to as "Windows Vista", "Windows 7", "Windows 8", "Windows 8.1", "Windows 10", "Windows Server 2008", and "Windows Server 2012". Furthermore, the collective term "Windows" is used to refer to them all.

- OS X 10.7.x
- OS X 10.8.x
- OS X 10.9.x
- OS X 10.10.x
- OS X 10.11.x

In this guide, the operating systems above are referred to as "OS X 10.7.x", "OS X 10.8.x", "OS X 10.9.x", "OS X 10.10.x", and "OS X 10.11.x". Furthermore, the collective term "OS X" is used to refer to them all.

Trademarks

EPSON is a registered trademark, EXCEED YOUR VISION, ELPLP and their logos are registered trademarks or trademarks of Seiko Epson Corporation.

Mac, Mac OS, and OS X, are trademarks of Apple Inc.

Microsoft, Windows, Windows Vista, Windows Server, PowerPoint, Excel, and the Windows logo are trademarks or registered trademarks of Microsoft Corporation in the United States and/or other countries.

WPA™, WPA2™, and Wi-Fi Protected Setup™ are registered trademarks of Wi-Fi Alliance.

App Store is a service mark of Apple Inc.

Google play is a trademark of Google Inc.

HDMI and High-Definition Multimedia Interface are the trademarks or registered trademarks of HDMI Licensing LLC. 

MHL, the MHL logo, and Mobile High-Definition Link are the trademarks or registered trademarks of MHL and LLC in the United States and/or other countries.

"QR Code" is a registered trademark of DENSO WAVE INCORPORATED.

PJLink trademark is a trademark applied for registration or is already registered in Japan, the United States of America and other countries and areas.

Foxit PDF SDK Copyright ©2011, Foxit Software Company
www.foxitsoftware.com, All rights reserved.

Crestron® and Crestron RoomView® are registered trademarks of Crestron Electronics, Inc.

Ubuntu and Canonical are registered trademarks of Canonical Ltd.

Eneloop® is a registered trademark of the Panasonic Group.

Other product names used herein are also for identification purposes only and may be trademarks of their respective owners. Epson disclaims any and all rights in those marks.

Seiko Epson Corporation shall not be liable against any damages or problems arising from the use of any options or any consumable products other than those designated as Original Epson Products or Epson Approved Products by Seiko Epson Corporation.

The contents of this guide may be changed or updated without further notice.

Illustrations in this guide and the actual projector may differ.

Copyright Attribution

This information is subject to change without notice.

©SEIKO EPSON CORPORATION 2016. All rights reserved.

2016.09 413320300EN

Copyright Notice

All rights reserved. No part of this publication may be reproduced, stored in a retrieval system, or transmitted in any form or by any means, electronic, mechanical, photocopying, recording, or otherwise, without the prior written permission of Seiko Epson Corporation. No patent liability is assumed with respect to the use of the information contained herein. Neither is any liability assumed for damages resulting from the use of the information contained herein.

Neither Seiko Epson Corporation nor its affiliates shall be liable to the purchaser of this product or third parties for damages, losses, costs, or expenses incurred by the purchaser or third parties as a result of: accident, misuse, or abuse of this product or unauthorized modifications, repairs, or alterations to this product, or (excluding the U.S.) failure to strictly comply with Seiko Epson Corporation's operating and maintenance instructions.